



# KOSOVO ENERGY SECURITY OF SUPPLY

## JO 27: ASSESSMENT OF PV GENERATORS IN KOSOVO

### SUMMARY REPORT

January 2021

This publication was produced for review by the United States Agency for International Development. It was prepared by DT Global.

# KOSOVO ENERGY SECURITY OF SUPPLY (KESS)

## JOB ORDER KESS – 027 ASSESSMENT OF PV GENERATORS IN KOSOVO

### SUMMARY REPORT

**Contract No:**

AID-167-C-17-00004

**Submitted to:**

USAID Kosovo

**Prepared by:**

DT Global

**Photo Caption:**

Solar PV park in Kamenica Photo by KESS

**DISCLAIMER:**

The authors' views expressed in this document do not necessarily reflect the views of the United States Agency for International Development or the United States Government.

## CONTENTS

<b>Executive Summary</b> .....	<b>1</b>
<b>Introduction</b> .....	<b>2</b>
<b>Solar potential in Kosovo</b> .....	<b>4</b>
<b>Policy, Legal and Regulatory Framework</b> .....	<b>5</b>
<b>Types of PV generators</b> .....	<b>6</b>
Large solar PV generators .....	6
Prosumers (Self-consumption Generators).....	6
Behind-the-meter PV installations .....	7
Off-grid solar PV .....	8
<b>Status of PV deployment in Kosovo</b> .....	<b>9</b>
<b>PV Sector perceptions and experiences</b> .....	<b>11</b>
<b>Future projects pipeline</b> .....	<b>12</b>
<b>Grid Integration</b> .....	<b>14</b>
<b>Financing Solar PV in Kosovo</b> .....	<b>15</b>
Present Status of Solar PV Projects .....	15
Financial Analysis of Solar PV Projects .....	15
financing Solar PV Projects .....	17
Challenges to Financing Solar PV Projects.....	18
Suggestions for Improving Financing Options for Solar PV Projects.....	19
Next Step.....	20
<b>Barriers and recommendations</b> .....	<b>21</b>
Integration of renewable self-consumers.....	21
Large solar PV generators based on unsolicited procedures.....	23
Large solar PV generators based on solicited procedures (tender or auction) .....	24
Other barriers .....	25
<b>Gender inclusion, Education and Job opportunities in RES/ PV Solar sector in Kosovo.</b>	<b>27</b>
Job opportunities .....	27
Education .....	27
Gender Inclusion.....	28

## FIGURES

Figure 1 Long-term average photovoltaic power potential (PVO <sub>OUT</sub> ).....	4
Figure 2 Large solar PV generator.....	6
Figure 3 Business with status of a Prosumer and solar PV installation.....	6
Figure 4 Household with a status of a Prosumer and solar PV installation.....	7
Figure 5 Business customer with Behind-the-meter solar PV installation.....	7
Figure 6 Behind-the-meter generator.....	8
Figure 7 Off-grid solar PV generator in agriculture.....	8
Figure 8 Installed PV capacity in Kosovo during period 2013 – 2020.....	9
Figure 9 Total installed solar PV capacity by end of 2020.....	10
Figure 10 Distribution of major solar PV installations in Kosovo.....	10
Figure 11 Possible pipeline of future solar PV projects in Kosovo.....	12

## TABLES

Table 1 Matrix of potential pipeline of future solar PV projects.....	13
---	----

## Abbreviations

AI	Administrative Instruction
CEFTA	Central European Free Trade Agreement
CEP	Clean Energy for all Europeans Package
CP	Contracting Party of the Energy Community Treaty
DFC	U.S. International Development Finance Corporation
DFI	Development Finance Institutions
DSO	Distribution System Operator
EBRD	European Bank for Reconstruction and Development
EC	European Council
EnC	Energy Community
EnCT	Energy Community Treaty
EPC	Engineering-Procurement-Construction
ERO	Energy Regulatory Office
EU	European Union
FiT	Feed-in Tariff
GoK	Government of Kosovo
IFC	International Finance Corporation
IPA	Instrument for Pre-Accession Assistance
KEDS	Kosovo Energy Distribution Services
KESCO	Kosovo Company for Supply of Energy
KESS	Kosovo Energy Security of Supply (A USAID project implemented by DT Global)
KIESA	Kosovo Investments and Enterprise Support Agency
KOSTT	Transmission, System and Market Operator of the Republic of Kosovo
Ktoe	Kiloton of oil equivalent
kW	Kilowatts (capacity)
kWh	Kilowatthours (energy)
MAFRD	Ministry of Agriculture, Forestry and Rural Development
MED	Ministry of Economic Development (now part of MEE)
MEE	Ministry of Economy and Environment
MESP	Ministry of Environment and Spatial Planning (now part of MEE)
MF	Ministry of Finance
MO	Market Operator, electricity
MTI	Ministry of Trade and Industry
NECP	National Energy and Climate Plan(s)
NREAP	National Renewable Energy Action Plan
PPA	Power Purchase Agreement
PPP	Public Private Partnership
PV	Photovoltaics
RES	Renewable Energy Source(s)
TSO	Transmission System Operator
USAID	United States Agency for International Development
VAT	Value Added Tax

## EXECUTIVE SUMMARY

Kosovo is a Contracting Party (CP) to the Energy Community Treaty (EnCT), established between the European Union (EU) and countries of Southeast Europe to extend the EU internal energy market to Southeast Europe and beyond. As a CP, Kosovo has taken on a number of obligations deriving from the EnCT, including mandatory targets for renewable energy (RE) share in the final energy consumption. To achieve the 2020 mandatory RE targets set by the EnCT, Kosovo has introduced policies, legal and regulatory framework and determined installed capacity for different types of renewable energy sources (RES) to be supported by an incentive scheme known as Feed-in Tariff (FiT). The FiT incentive scheme, along with the Authorization Procedure based on first-come-first-served principle has proven to be successful, as it has attracted both local and foreign private investment for construction of new RES based generation capacities and has helped Kosovo fulfill the 2020 RES targets. Local investors and lenders have invested in solar photovoltaics (PV) and small hydropower, while foreign investors, supported by international financing institutions including the European Bank for Reconstruction and Development (EBRD), have successfully implemented large wind projects.

In going forward, the European Commission (EC) has announced a new timeframe (mid-2021) for agreeing on even more ambitious RES targets that CPs should achieve by 2030.

For utility-scale solar PV project pipeline of 200 MW, Kosovo with the support of international partners is already in process of developing a new legal basis for private sector involvement based on auctions and competitive tendering.

For small-scale, self-consumption solar PV projects, Kosovo has introduced a different support scheme in the form of net-metering, which has so far proven to be moderately successful due to the number of both legal and technical barriers. The implementation of the ambitious (250 MW), future small-scale solar PV project pipeline depends on the elimination of identified barriers as well as measures required to successfully integrate these projects into the electricity network.

The current investment climate for small-scale solar PV projects in Kosovo can be considered moderately favorable as local banks and Multilateral Financing Institutions (MFIs) are already providing financing based on market interest rates, and the Kosovo Credit Guarantee Fund (KCGF) is providing loan guarantees. Additionally, the EBRD GEFF & SME has on lending programs, and banks and larger MFIs have already expressed interest in expanding their lending window for solar PV.

For utility-scale solar PV projects, key challenges are linked with the need to cover liquidity, policy, political, and business interruption risks and the need to improve project finance knowledge (e.g., structure, security, and risk mitigation). Other key challenges include standardized contracts and project documents (e.g., Power Purchase Agreements (PPA)), as well as the lack of experience in implementing new procurements and pricing and contracting mechanisms, such as a standardized auction procedure.

Kosovo remains committed to diversifying its generation portfolio in an effort to achieve an increased share of RE in its final energy consumption that is in line with EnCT obligations, the Washington Agreement, and Sofia Agreement endorsing the Green Agenda for the Western Balkans. These commitments will require the mobilization of hundreds of millions of dollars in private sector investment based on competitive and transparent processes, continued reform within legal and regulatory RE frameworks, and the strengthening and modernization of the electrical grid to accommodate large intermittent generation capacities and better integration of prosumers.

## INTRODUCTION

This Summary Report of Kosovo Energy Security of Supply (KESS) activity titled “Assessment of PV generators in Kosovo”, summarizes findings elaborated in great detail in three accompanying Annex reports:

- Annex 1 – Status of PV deployment in Kosovo
- Annex 2 – Solar PV outlook for Kosovo 2030
- Annex 3 – Barriers and Recommendations

The overall objective of this activity is to support the Government of Kosovo (GoK) and USAID in assessing the potential to expand renewable energy source (RES), focusing particularly on solar photovoltaics (PV), on identifying factors to improve the enabling environment for increased private sector PV investments, and increasing the share of solar PV in the final consumption of electricity, resulting in improved energy system resilience.

The results of this 3-month activity are built on experiences of the private sector and the challenges it faced to develop new PV generation in Kosovo, provides understanding of these obstacles and opportunities, and delivers a set of clear recommendations for increased private sector investment in solar PV. The information was collected by site visits, online questionnaires, and video interviews.

The objective is in harmony with USAID Kosovo CDCS:

- Opportunities for private sector engagement
- Pipeline of investment opportunities (DFC, private sector, and the GOK)
- Enhanced environment for private investment (legal and non-legal barriers)
- Promotion of expanded electricity generation from RE for cleaner energy supply, enhancing diversification and energy system resilience.
- Improved human capital (educated youth to meet private sector needs)

The Annex I – Status of PV deployment in Kosovo, is organized in following sections:

- **Section 1 – Solar Energy and Renewable Energy Source in Kosovo:** describes key definitions of solar energy and power and provides solar photovoltaics (PV) potential in Kosovo based on data from Global Solar Atlas. This section also describes typical types of solar PV projects as definition in Kosovo’s legal and regulatory framework in force.
- **Section 2 – Legal, Policy and Regulatory Framework for PV projects in Kosovo:** describes Kosovo’s international obligations, current policy and strategy, legal and regulatory framework for renewable energy sources (RES) with particular focus on solar photovoltaics (PV) projects development.
- **Section 3 - Administrative Procedures for PV project Development:** describes in more depth the application procedure and required supporting documents for developers to obtain the authorization for construction of new photovoltaic generation capacities.
- **Section 4 - Status of PV deployment in Kosovo:** describes the outcomes and concrete results of policy, legal and regulatory framework by summarizing all solar PV projects implemented by end of 2020 in Kosovo.
- **Section 5 - PV Sector perceptions and experiences:** summarizes private sector perceptions and experiences faced with current legal, regulatory, and institutional framework, while developing and constructing new solar PV generation capacities.

While Annex 1 report is retrospective and builds on experiences to date, the Annex 2 and Annex 3 reports are forward looking and provide outlook of future solar PV projects as well as set of recommendations for improving enabling environment where solar PV can have significant share in final electricity consumption in comparison to the current insignificant share of 0.04%.

The Annex 2 – Solar PV Outlook for Kosovo 2030, is organized in following sections:

- **Section 1 – Solar PV Projects Pipeline:** Summarizes and describes the pipeline of potential new solar PV projects based on different project categories, procedures, and their implementation likelihood.
- **Section 2 – Financing Solar PV in Kosovo:** Describes the overall renewable energy financing climate, investment risk profile, prospects for investments, Development Finance Institutions (DFI) involvement, and provides examples of financing structures for large scale and other solar PV projects in Kosovo.
- **Section 3 – Kosovo Electricity Demand Forecast 2030:** Builds on top of existing electricity demand scenarios and extrapolates electricity demand to 2030.
- **Section 4 – Kosovo RES Targets 2030:** Describes Kosovo’s mandatory and voluntary renewable energy source (RES) targets for 2020, achievements, expected new Kosovo 2030 targets, envisaged solar PV installed capacity according to the National Energy and Climate Plan (NECP), and describes the new solar PV project pipeline’s share in meeting gross electricity demand in 2030.
- **Section 5 - Grid Integration & Energy Market:** Describes status of the distribution and transmission grid allowing new RE project integration and describes electricity market operation in the coupled Kosovo/Albania electricity market.
- **Section 6 - Gender inclusion, Education and Job opportunities in RES/PV Solar sector in Kosovo:** This section provides information on current job market and potential employment opportunities in the solar PV sector of Kosovo. It also outlines information on gender inclusion and education opportunities to meet market needs with respect to human capital, while providing a set of recommendations to the government on improving curricula, developing training programs and improving gender balance in the sector.

The Annex 3 – Barriers and Recommendations, is the third in a series of reports on the solar photovoltaic situation in Kosovo and provides recommendations on improving the legal and regulatory environment for solar photovoltaic (PV) deployment in the country. The Annex 3 report is divided into four parts, each focused on a different functional topic:

- Part 1 is focused on integration of renewable self-consumers;
- Part 2 is focused on large solar PV generators based on unsolicited procedures;
- Part 3 is focused on large solar PV generators based on forthcoming solicited procedures;
- Part 4 is focused on all other barriers.

Renewable energy and solar PV in particular is considered a very young sector in Kosovo. With first small-scale, off-grid commercial PV projects installed in 2013, followed with gradual introduction of legal and regulatory framework and incentives, the solar PV sector grew modestly, resulting with over 1,300 solar PV projects (or 20.9 MW total installed capacity), implemented by a dozen of newly established local private sector installation firms.

The identified solar PV sector growth potential will help Kosovo in fulfilling its commitment to diversify the generation portfolio in effort to achieve increased share of Renewable Energy in final energy consumption. This effort will require mobilization of hundreds of millions private sector investment based on competitive and transparent processes, continued reform in the legal and regulatory framework, and strengthening and modernization of electrical grid to accommodate large intermittent generation capacities and better integration of prosumers.

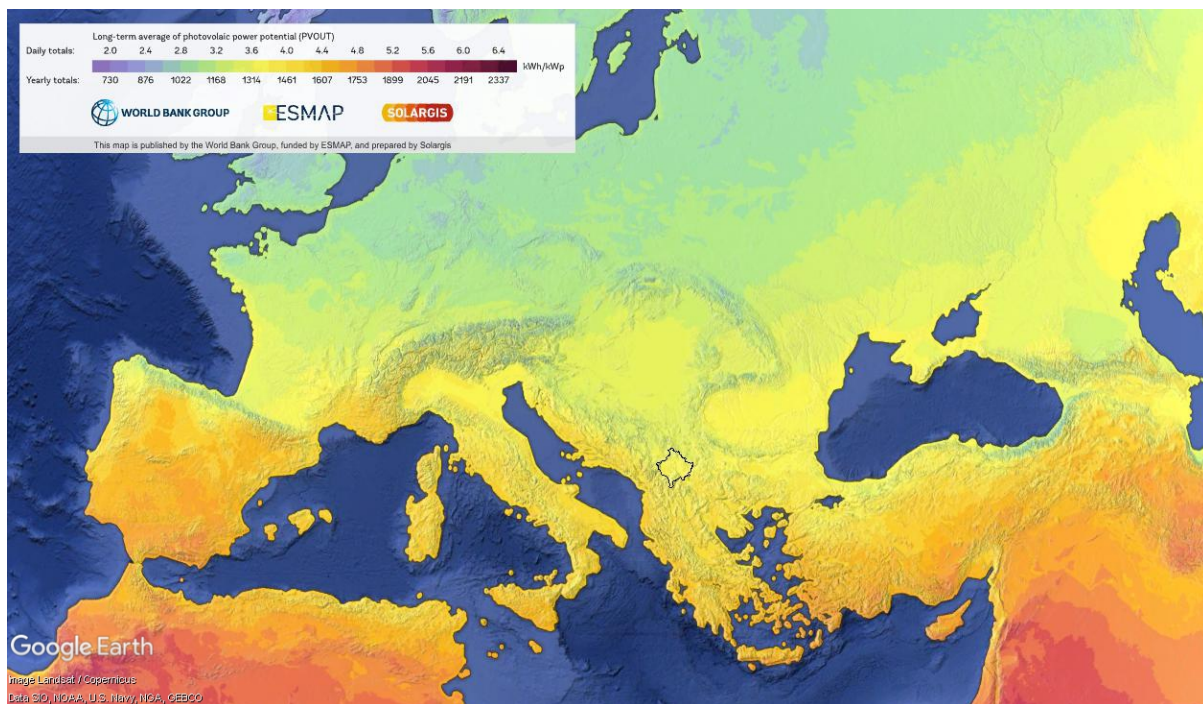


## SOLAR POTENTIAL IN KOSOVO

The solar energy is radiant light and heat energy released from the Sun that can be harnessed using a range of ever-evolving technologies. The utilization of solar energy by direct conversion of light into electricity using the photoelectric effect of the solar cells installed on solar panels is known as solar power or solar photovoltaics (PV) energy.

The potential solar energy that could be utilized differs from the amount of solar energy present near the surface of the planet because factors such as geography, time variation, cloud cover, and the land availability, limit the amount of solar energy that we can acquire. Geography affects solar energy potential because areas that are closer to the equator are closer to the Sun and receive a higher amount of solar radiation.

Time variation also effects the potential of solar energy because during the nighttime or wintertime, there is little solar radiation on the surface of the Earth for solar panels to absorb. This limits the amount of energy that solar panels can absorb in one day. Cloud cover is another important factor that impacts the energy yield of solar panels; therefore, this resource is considered to be intermittent.



**Figure 1 Long-term average photovoltaic power potential (PVOUT).**

Data Source: Global Solar Atlas. <https://globalsolaratlas.info>

Based on data from the Global Solar Atlas, the average daily yield potential of 1 kW of installed solar PV capacity in Kosovo is around 3.7 kWh/kWp or 1,350 kWh/kWp in a year. The PV power output (PVOUT) represents the amount of power generated per unit of the installed PV capacity over the long-term, and it is measured in kilowatthours per installed kilowatt-peak of the system capacity (kWh/kWp). The practical PV potential, is the power output achievable by a typical configuration of the utility scale PV system, taking into account the theoretical potential, the air temperature affecting the system performance, the system configuration, shading and soiling, and topographic constraints. On a global scale power output of 3.7 kWh/kWp is considered supportive of new solar PV development and offers acceptable return on investment.

## POLICY, LEGAL AND REGULATORY FRAMEWORK

Since 2005 when Kosovo became a signatory party to the Energy Community Treaty, it has transposed into its national law a number of EU secondary law sources pertaining to the energy sector. Overall, Kosovo has a sound legal framework and has achieved advanced level of implementation of Energy Community obligations in the electricity sector:

- The Legal framework (primary and secondary legislation) is still moderately developed for renewable energy, climate, environment, energy efficiency, and Kosovo lags with natural gas and oil sector legal framework development.
- The Regulatory Framework is defined under ERO issued Rules that allow administration of Authorizations for construction of new renewable energy projects and admission to various Support Schemes.

The current legal and regulatory framework provide initial building blocks and as a result number of new RE projects have been developed and others are under development. The Annex I report describes in detail Kosovo's international obligations, current policy and strategy, legal and regulatory framework for renewable energy sources (RES) with particular focus on solar photovoltaic (PV) projects development.

The Legal, Policy and Regulatory Frameworks section of Annex I report is divided into five parts:

1. Introduces Kosovo's international obligations deriving from the Energy Community Treaty, applicable EU laws, regulations and guidelines, and mandatory RES targets.
2. Focuses on Kosovo RES policy, Kosovo Energy Strategy, and National Renewable Energy Action Plan (NREAP).
3. Covers the applicable legal & regulatory framework for RES in Kosovo.
4. Highlights fiscal policy as applicable to the RES sector.
5. Provides an overview of Kosovo's stakeholders governing the energy sector.

Kosovo's existing policy framework is outlined in following documents:

- Kosovo Energy Strategy (2017-2026), and Strategy Implementation Plan
- National Renewable Energy Action Plan (2013). The NREAP has provided a mandatory RES target of 25% in gross final energy consumption and a voluntary target of 29.47% by 2020,
- Administrative Instructions on establishment of RES mandatory targets and RES capacities to be admitted to Support Scheme based on Feed-in Tariffs.

In 2020, the Ministry of Economy and Environment (MEE) begun with drafting of the National Energy and Climate Plan (NECP) which stems from the Clean Energy Package for all Europeans and is in initial stages of revisioning the Kosovo Energy Strategy for next 10-year period. In parallel, the MEE supported by EBRD is developing a competitive market-based mechanism based on auction for development of large utility scale wind and solar PV projects.

The Annex I report continues to describe in more depth the application procedure and required supporting documents for developers to obtain Authorization for construction of new photovoltaic plants and admission to various support schemes. The Administrative procedures section is divided into three parts:

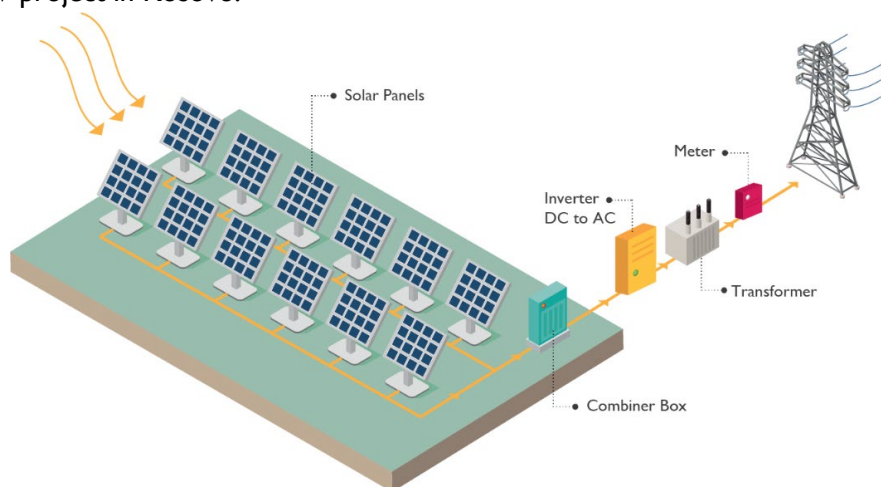
- Authorization Process for Large PV, and Small PV generation.
- Authorization Process for Small PV Self-consuming generators (Prosumers), and
- Permitting process for self-consuming generators that are not connected to the grid.

## TYPES OF PV GENERATORS

The following section describes typical solar PV project types as defined in the legal and regulatory framework of Kosovo. These definitions are then used throughout the reports.

### LARGE SOLAR PV GENERATORS

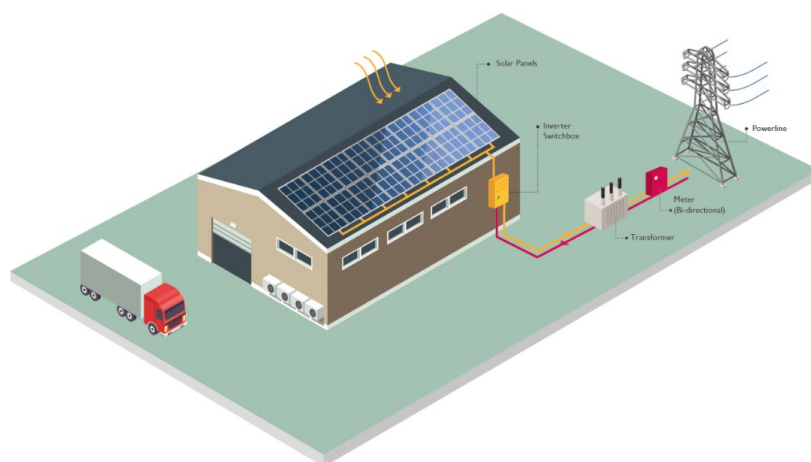
Large solar photovoltaic (PV) generators in Kosovo are considered those with installed capacity over 100 kW. If the generator is part of the Support Scheme, i.e., project benefiting from the 12-year guaranteed Power Purchase Agreement with Feed-in Tariff, priority dispatch and liable for only 25% of their disbalance, then the maximum allowed size of single project is limited to 3 MW. Large solar PV projects may be connected to the distribution or transmission network. Figure 2 illustrates a typical large solar PV project in Kosovo.



**Figure 2 Large solar PV generator**

### PROSUMERS (SELF-CONSUMPTION GENERATORS)

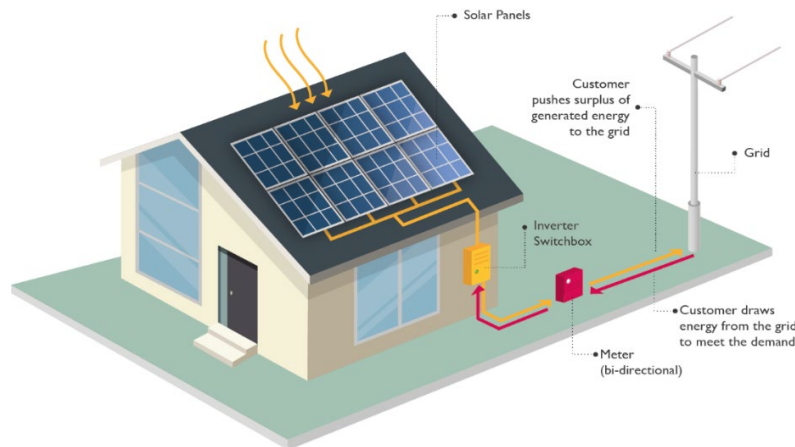
Any customer (households, business, and public institutions) connected to the low-voltage distribution network is allowed to install a small (<100kW) solar PV system to meet part of their own demand as a cost saving measure or to reduce their CO<sub>2</sub> footprint. If the customer is authorized by Energy Regulatory Office to construct such installation and meets the technical and legal conditions, then the customer is admitted to the Support Scheme and obtains status of a “Prosumer”. Figure 3. Illustrates a business with status of a Prosumer.



**Figure 3 Business with status of a Prosumer and solar PV installation**

To improve bankability of the small PV installations, Prosumers are allowed to inject excess electricity to the grid that is metered by a bi-directional meter and credited to future energy consumption within the same billing period. This is known as net-metering or Prosumer support scheme.

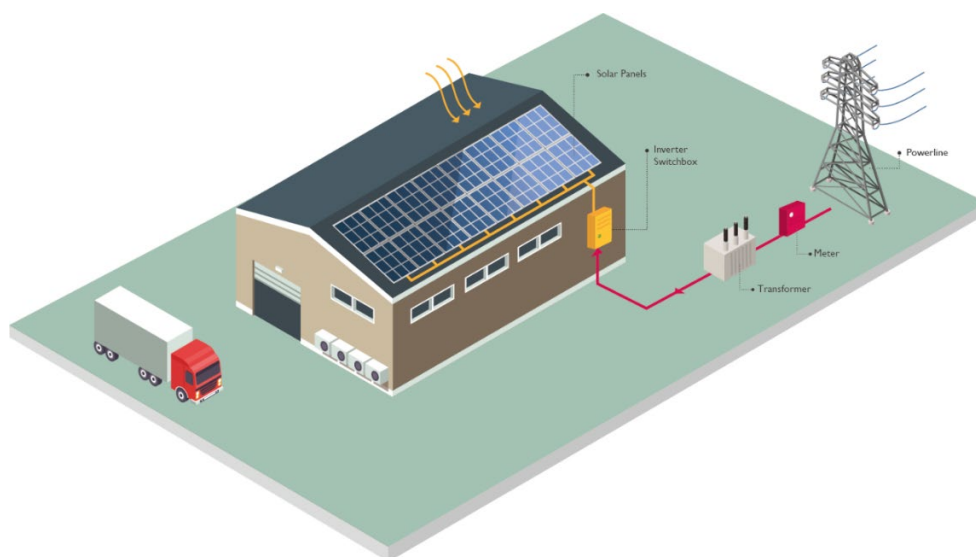
When the PV system does not generate enough to cover their electricity demand, a Prosumer receives electricity from the grid, similar to regular customers. Figure 4 illustrates a typical household Prosumer.



**Figure 4 Household with a status of a Prosumer and solar PV installation**

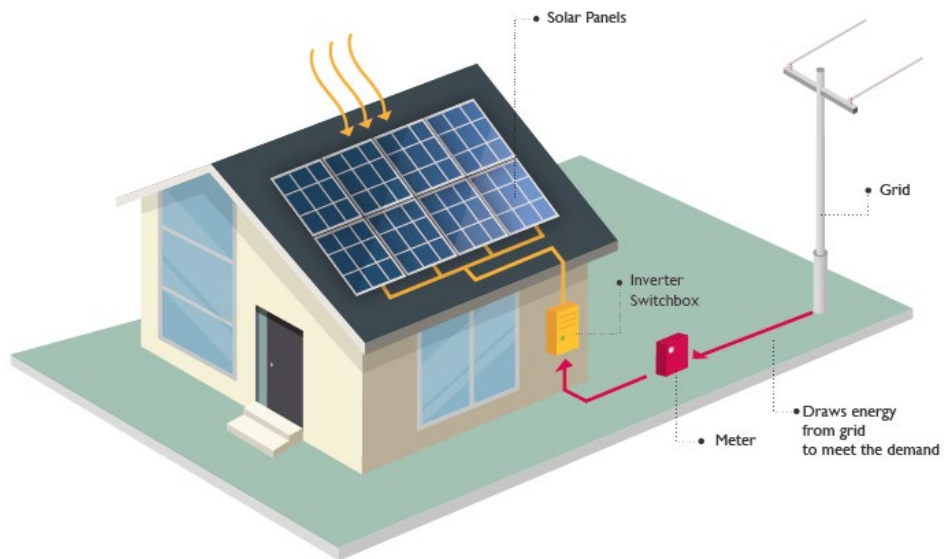
## BEHIND-THE-METER PV INSTALLATIONS

Any consumer of electricity can install any size solar PV installation to meet their entire or part of their electricity demand as their own internal electricity supply option, a cost saving measure by offsetting their energy consumption from the grid, or to reduce their CO<sub>2</sub> footprint. The entire generated electricity from such solar PV system is consumed internally and no electricity is injected to the grid. Hence, this type of system is referred throughout this report as Behind-the-meter system or as industry refers to “zero export” installation. Figure 5 illustrates a typical business with Behind-the-meter solar PV installation.



**Figure 5 Business customer with Behind-the-meter solar PV installation**

Figure 6 below illustrates a typical Behind-the-meter household installation.

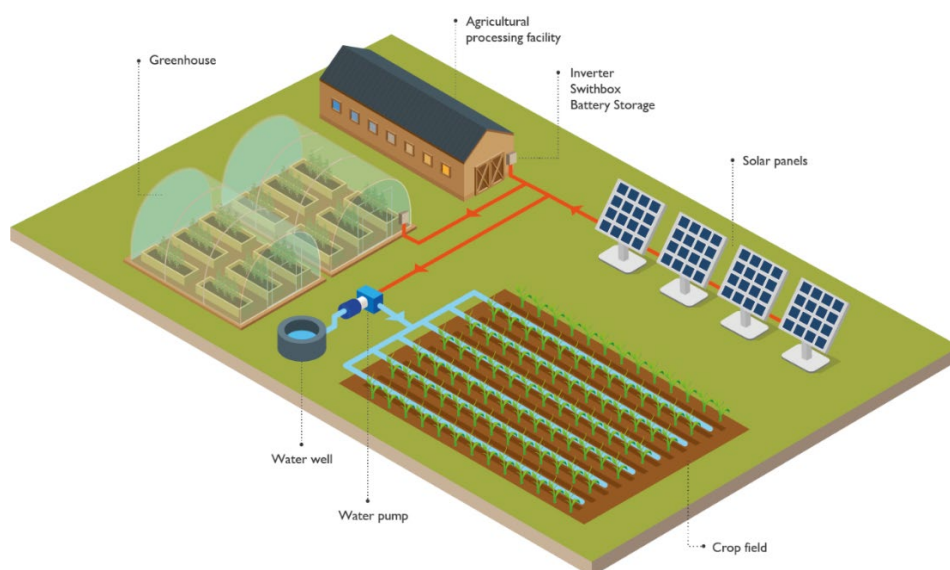


**Figure 6 Behind-the-meter generator**

In case such consumer is also a customer of the electricity supply company they continue to receive regular electricity supply from the grid when their solar PV system does not meet the demand.

## OFF-GRID SOLAR PV

There are more than a thousand solar PV installations throughout Kosovo that are completely off-grid (meaning they are not connected to the grid). These types of solar PV installations which are found mainly in agricultural sector are used for water pumping or providing electricity supply to green-houses or processing facilities in the remote areas. These projects are supported through agricultural grants. Figure 7 below illustrates a typical off-grid solar PV generator in agriculture.

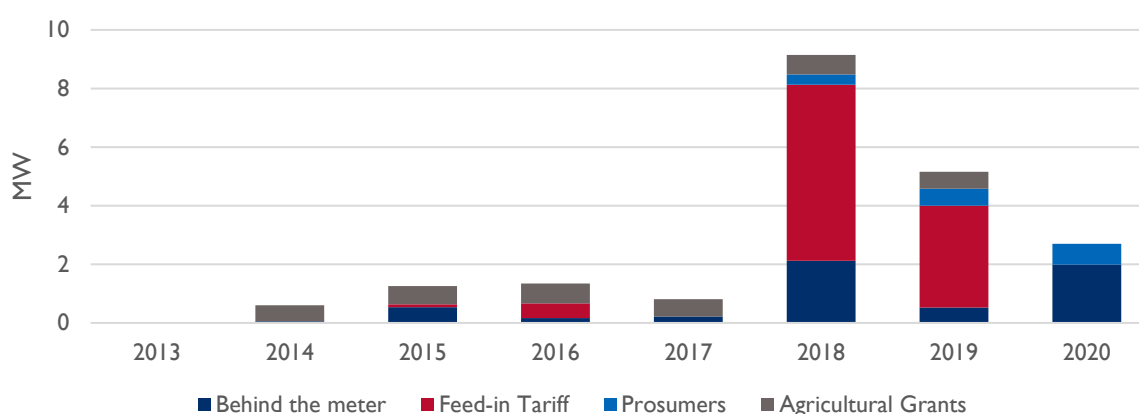


**Figure 7 Off-grid solar PV generator in agriculture**

## STATUS OF PV DEPLOYMENT IN KOSOVO

Kosovo's existing RE policy and legislative framework has resulted with fulfillment of defined targets for photovoltaics (PV) energy. The PV targets are achieved via support mechanism based on Feed-in Tariffs, however, there is a growing trend in Behind-the-meter and Prosumer installations.

Since 2013, solar PV sector continued to grow despite many challenges it faced as new industry. The real boost to the sector came in 2014 when Ministry of Agriculture introduced RE measures within the agricultural grant scheme. Based on the number of grants issued since 2014, and information from MAFRD and installations firms, there are about 1,073 installed off-grid projects in the agricultural sector, with total installed capacity of 3,690 kW. The average installed capacity of solar PV for agricultural grants is between 1 and 5 kW per project and between 6-12 kW for agro-processing facilities. This trend had numerous effects, with immediate being capacity building of installation firms' experience and their establishment in the market, job creation, and ultimately increase of installed solar PV capacity. Behind-the-meter solar PV installations pioneered solar energy in Kosovo. The dynamics of new solar PV installations during period 2013 -2020 is presented in Figure 8 below.



**Figure 8 Installed PV capacity in Kosovo during period 2013 – 2020**

The Support Scheme based on **Feed-in Tariff**, during period 2013-2019, resulted with total 42 applications, and out of these:

- 10 MW or six (6) applications were granted with Final Authorization and are in operation
- 20 MW or eight (8) applications were granted with Preliminary Authorization
- 82.267 MW or twenty-eight (28) applications received Preliminary Authorization and are considered as “pending applications” or “the waiting list”.

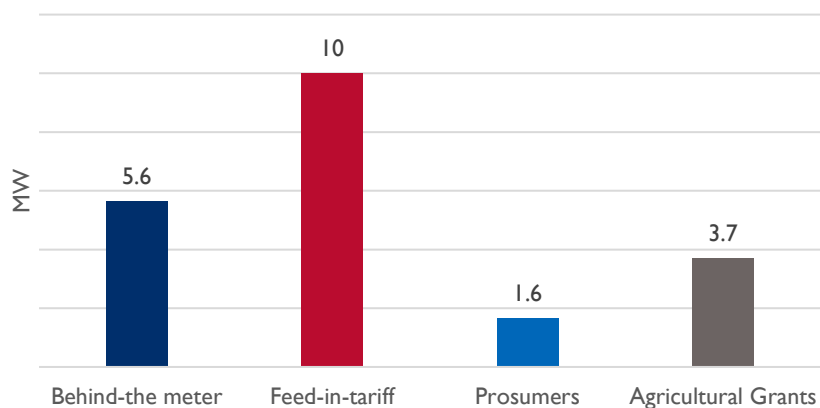
The Support Scheme for **Self-consumption generators** / Prosumer (based on net-metering) introduced in 2018 and up to the beginning of December 2020, has resulted in:

- 1,527.91 kW or fifty (50) authorized projects that are in operation
- 67.2 kW or one (1) project in process of review

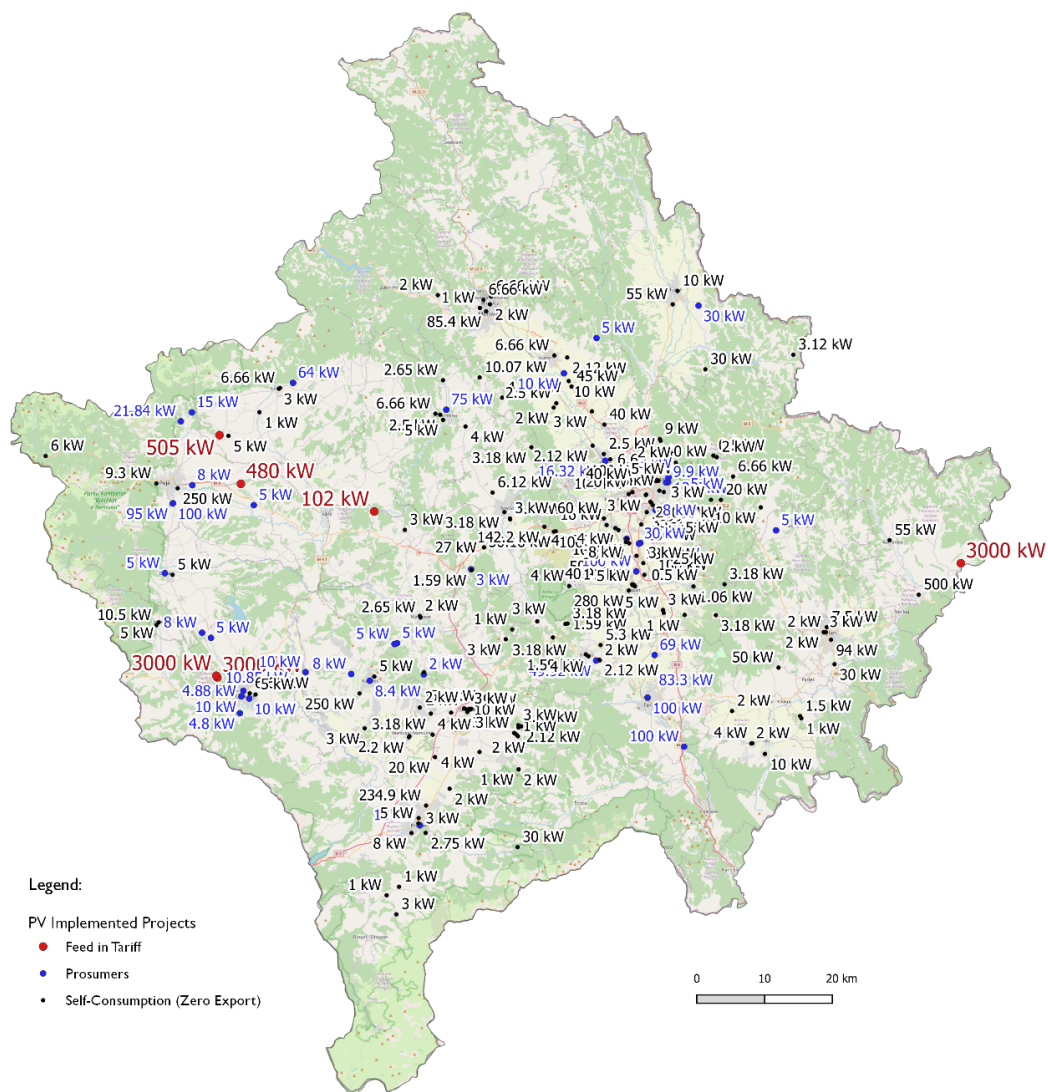
During period 2013 – 2020, a considerable number of **Behind-the-meter** installations have been completed. Based on KESS survey carried out during October-November 2020, there are at least 180 such installations found mainly in private sector business active in distribution, retail, and manufacturing.

The Support Scheme based on **Regulated Framework** (which includes RES reference price) has not been utilized by any developer to date.

The total solar PV installed capacity by end of 2020 is 20.9 MW, and when converted to energy it represents a modest share of 0.04% of total electricity consumption in Kosovo. Total installed capacity by project type is presented in Figure 9 and their geographical distribution of installations is shown in Figure 10.



**Figure 9 Total installed solar PV capacity by end of 2020**



**Figure 10 Distribution of major solar PV installations in Kosovo**

## PV SECTOR PERCEPTIONS AND EXPERIENCES

Renewable energy and solar PV in particular is considered a very young sector in Kosovo. With first small-scale, off-grid commercial PV projects installed in 2013, followed with gradual introduction of legal and regulatory framework and incentives, the solar PV sector grew modestly, resulting with over 1,300 solar PV projects (or 20.9 MW total installed capacity), implemented by a dozen of newly established local private sector installation firms.

Founding of a solar PV panel assembly plant in Kosovo (first in the Balkans), and full implementation of 10 MW target for solar PV are considered as highlights of this period.

This immature but rapidly developing market was faced with many challenges, including lack of investor confidence in new technology, slow return on investment due to high technology prices but also low electricity prices, modest incentives or support schemes, absence of clearly defined administrative procedures for authorization, permitting and grid integration, lack of skilled labor but most importantly lack of public awareness on reliability and benefits of solar PV technology.

Building on top of their experiences, the solar PV sector is slowly organizing itself in associations, formulating their concerns, and raising their voice in effort to eliminate barriers, simplifying procedures, and proposing new incentive measures to make solar PV more attractive to private investors.

A list of major concern raised by the solar PV sector is as follows:

- Limitation imposed on solar PV installed capacity for business prosumers;
- Limitations imposed on voltage level connection for business prosumers;
- Complex, timely and costly procedures for obtaining status of prosumer, mostly impacting return on investment for small household solar PV projects;
- Unclear requirements and lack of uniformity for obtaining Municipal permit for rooftop solar;
- Unnecessary requirement to have ERO Board approve Prosumer applications;
- Long list of documentation evidence required for obtaining project approvals with DSO;
- Unnecessary technical requirements imposed by DSO such as installation of additional electrical protection equipment, restriction on equipment manufacturers or requirement for additional certification;
- Lack of ERO approved methodology for connection to the DSO grid resulting with increased cost for larger solar PV projects due to deep connection requirement or determination of connection point further away from the project site;
- Transfer of ownership to DSO, such as transformers, without compensation;
- Imposition by DSO for installation firm to carry out grid assessment studies outside of project site to the connection point.

The solar PV sector greatest concern is related to complexity and uncertainty in procedures resulting with delays making these investments unattractive to household and private business investors. In majority of cases the installation firms offer to investors turnkey solution, including handling of administrative procedures, and often are faced with hurdles or delays that risk their reputation.

In addition to above listed concerns, the solar PV sector also proposed measures to improve feasibility of solar PV installations such as eliminating VAT on small household projects, making these projects more attractive by shortening payback period for approximately 2 years. Recommendations for overcoming these barriers are broken down in detail in Annex 3 report of Job Order KESS-027.

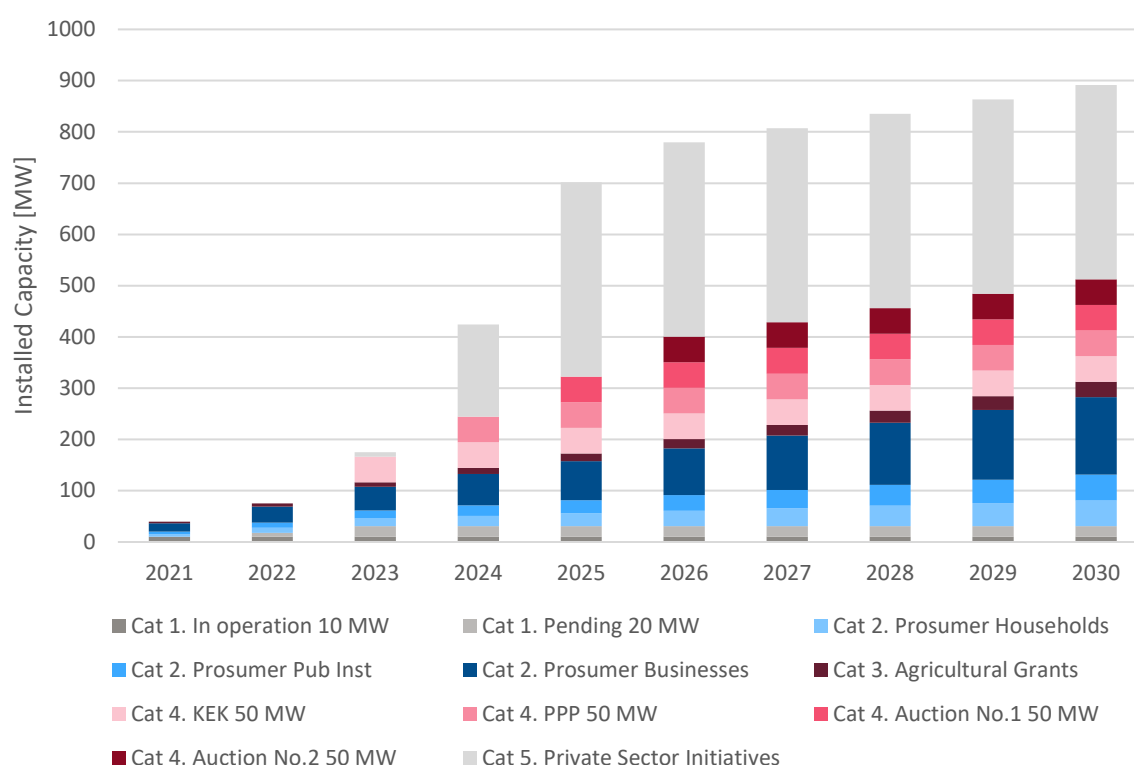


## FUTURE PROJECTS PIPELINE

The potential pipeline of future solar PV projects in Kosovo as summarized in Figure 11 below is the result of data collected through interviews with government institutions, the Regulator, public and private sector companies, international development agencies, and analysis of existing and draft national energy plans.

The future solar PV projects summarized in Figure 11 have been categorized as follows:

- Category 1. Projects based on support scheme with Feed-in Tariffs
- Category 2. Projects for self-consumption (Prosumers and Behind-the meter installations)
- Category 3. Agricultural grants and subventions
- Category 4. Large utility-scale projects (based on tendering, auctions)
- Category 5. Private sector initiatives (based on Law on Strategic Investments)



**Figure 11 Possible pipeline of future solar PV projects in Kosovo**

Based on electricity demand forecast 2021 - 2030, the proposed 310 MW new solar PV capacity in the NECP would meet approximately 6.7% of electricity demand by 2030.

The development of projects envisaged under the possible pipeline of future solar PV projects in Kosovo (Figure 11) and their share in gross electricity demand is presented in two scenarios:

- Scenario 1: Projects with high likelihood of implementation (Category 1 to 4), meeting 11% of the gross electricity demand in 2030; and,
- Scenario 2 – All projects, including Private Sector Initiatives based on Law on Strategic Investments, meeting 19.2% of the gross electricity demand in 2030.

**Table I Matrix of potential pipeline of future solar PV projects**

	Category 1	Category 2	Category 3	Category 4	Category 5
<b>Project Type</b>	<b>Authorization Procedure Supported with Feed-in Tariffs.</b> Implementation of these projects is pending court decision.	<b>Self-consumption</b>  Prosumers and Behind-the-meter	<b>Agricultural Grants &amp; Subventions</b>	<b>Utility-scale projects</b>  Based on Tendering, Auctions, and KEK initiatives	<b>Private sector initiatives</b>  Based on Law on Strategic Investments)
<b>Capacity [MW]</b>	20	250	30	200	~380
<b>Number of projects</b>	8 (No. of projects with Preliminary Authorization)	8,000 households 2,000 public buildings 1,000 businesses	3,500 – 4,000 farms and agro-processing facilities	4 projects  50 MW KEK 50 MW MEE-IFC 2x50 MW EBRD	~10
<b>Project Cost [Euro/kW]</b>	< 800	800 – 1,200	1,800 – 2,000	< 800	< 800
<b>Estimated Investment Volume [Euro million]</b>	20	300	50	160	320
<b>Financing</b>	Local Commercial	Local Commercial	GoK / Local	DFI / IFI Commercial	DFI / IFI Commercial
<b>Support Mechanism</b>	Feed-in tariff	Net-metering Net-billing	Grants Subventions	PPP Long term PPA	Various
<b>Estimated New Long-term Jobs created</b>	20 in operation stage	1,500 - 2,000 installers	250 installers	20 in operation stage	20 in operation stage
<b>Grid Connection</b>	KEDS (Distribution)	KEDS (Distribution)	KEDS (Distribution)	KOSTT (Transmission)	KEDS/KOSTT
<b>Balancing Responsibility</b>	Yes	Depending on single project size	Depending on single project size	Yes	Yes
<b>Typical type of installation</b>	Ground	Roof-top	Ground Roof-top	Ground	Ground
<b>Battery Storage</b>	No	Possibly	Most likely	TBD	No
<b>Possible USAID Support</b>	None	Technical Assistance: Legal, Administrative, Financial and Technical Barriers	None or Limited Technical Assistance to MAFRD (Database of solar PV projects)	Technical Assistance: Supporting Transaction and Implementing Agencies	None or Limited Technical Assistance to MTI-KIESA
<b>US Private Business Opportunity</b>	Limited  (possible support by DFC to KCGF)	Yes – Technology Providers (solar panels, battery storage)	Limited – Technology Providers (solar panels, battery storage)	Yes – DFI Financing, Technology, Private Investors	Unknown

The assumptions used for the solar PV project pipeline are described in the Annex 2 report. Subsequent detailed surveys and analysis will more finely detail the potential and likely timeline for each market segment.

## GRID INTEGRATION

Kosovo possesses a highly developed transmission system (TS) and is among top three countries in Europe in both, the ratio between interconnection capacities and installed production capacities, as well as ratio between interconnection capacities and the peak load. The installed transmission capacity of interconnectors is more than sufficient to afford high development of RES through 2030.

Support factors for RES Integration to TS:

- Reliable and secured transmission network;
- Priority dispatch;
- RES energy fund, managed by KOSTT;
- Market integration with Albania, and further integration in regional markets.

Constrains factors for RES Integration to TS:

- Lack of power reserves;
- Inflexible and aged TPP units;
- No energy storage facilities or flexible units.

Although the transmission network has sufficient capacities to integrate renewable sources, the problem for the System Operator remains the increase of systems regulatory reserve requirements, with particular emphasis on secondary and tertiary control reserves, due to the variable and highly unpredictable wind and solar sources. This difficulty may be reduced by integrating small markets into an integrated regional market where access to ancillary services will be easier, and the level of regulatory reserves required will also be reduced. Therefore, the ongoing process of creating a common electricity market between Kosovo and Albania, and further integration into the regional market, will contribute to reducing the problem of RES integration into the system. All these efforts resulted with the following main achievements:

- Albanian Power Exchange ALPEX fully established, KOSTT is shareholder;
- ALPEX will organize DAM and IDM in Albania and Kosovo;
- Expected Go-live by the end of 2021;
- Market Coupling AL-KS + 2 months after ALPEX Go-live;
- Opportunity for RES producers to offer and trade their energy in ALPEX.

Another potential mitigation measure is introduction of Utility Scale Battery Storage Systems offering wide spectrum of system services as described in detail in Annex 2 report.

Despite the very well-developed transmission system, Kosovo has a modestly developed distribution network that needs to be further improved to be able to integrate the planned increase of number of RES distributed generators, including self-generation/prosumers. The draft development plan of Distribution System Operator (KEDS) 2019 – 2028, focuses on the reduction of losses and improving the quality of supply to customers. However, there is no section in this development plan that particularly addresses the issue of integration of RES in the distribution system.

For RES including PV integration to DN the following developments are needed:

- Optimal investment in DN, in order to accommodate the planned RES capacities up to 2030;
- Setting up non-discriminatory and transparent technical criteria for RES integration;
- Methodology and cost for connection of PV; and
- Simplified process and procedures for becoming a Prosumer.

## FINANCING SOLAR PV IN KOSOVO

This section of the report summarizes the present status of solar PV projects in Kosovo, the current financing landscape for large, mid-sized, and small solar PV installations, financial analysis for typical projects, and the challenges to scaling up financing. Suggestions for improving the investment climate for solar PV projects and next steps for USAID support are also summarized.

### PRESENT STATUS OF SOLAR PV PROJECTS

Solar PV projects in Kosovo may broadly be categorized into the following market segments based on the type and size of project:

- Large utility scale grid-connected solar PV project
- Solar PV generators under Authorization Procedure (Support Schemes based on Feed-in Tariffs and Regulated Framework)
- Behind-the-meter installations (Off-grid installations and Prosumers with net-metering)

The above market segments differ in project size and in the purpose they serve. While large solar PV projects and projects benefiting from feed-in-tariffs and a regulated framework are revenue generating businesses which sell power to the electricity grid, the other projects are principally installed for self-consumption, though Prosumers connected to the grid with net energy metering can push or sell excess power to the grid.

Kosovo is yet to develop utility scale solar PV projects but has developed six solar PV farms through the Support Scheme – the largest of which has a capacity of 3 MW – with combined capacity of 10 MW.<sup>1</sup> Applications for 8 additional projects under the FIT are pending a court decision. KESS surveys indicate that about 180 behind-the-meter solar PV projects with cumulative capacity of about 5.6 MW have been installed in the agriculture, household, and business sectors. Prosumer projects in the agriculture sector typically range from 5-30 kW in capacity, about 3-7 kW in households, and average 63 kW among business prosumers.

### FINANCIAL ANALYSIS OF SOLAR PV PROJECTS

Financial models were used to examine the financial viability of typically sized solar PV projects in each market segment. A model was used to analyze the impact of key variables – project cost, interest rate on debt, and tenor of loan – on the internal rate of return (IRR) of the project and ability to service debt. The analysis was used to examine the bankability of projects and to identify financing options and instruments that could improve the investment climate for solar PV projects in Kosovo.

**Utility-scale grid connected projects.** As noted above, Kosovo is yet to develop large utility-scale solar PV projects. To illustrate the financing instruments and options for such projects, a project finance model was used to model a 50 MW solar PV plant to be developed at a site owned by KEK. The inputs to the model were validated by information from a feasibility study for solar PV project

---

<sup>1</sup> These projects were contracted under the former feed-in tariff (FIT) level of 136.4 EUR/MWh and have a 12-year PPA. In 2019, the ERO lowered the FIT to 85 EUR/MWh over a 12-year PPA. In its most recent board meeting, the ERO decided to end the FIT support scheme and move towards a Regulated Framework with a reference tariff.

prepared for KEK and data from IRENA.<sup>2</sup> The model was used to estimate the levelized cost of electricity (LCOE) and the IRR based on financing terms which could be available from DFIs.<sup>3</sup> A project finance structure was assumed similar to the large wind farms developed in Kosovo. The financing structure and terms have a very material impact on the LCOE, but the terms have not been discussed with the DFIs for this report. The results of the analysis and the implications for financing the hypothetical plant are realistic but illustrative.

The project was estimated to cost about \$40 million (with the exception of land costs) and was assumed to be financed with 70% debt at an interest rate of 4.0% with 1.0% lender's fee for a loan tenor of 15 years.<sup>4</sup> A 25-year fixed PPA and a Debt Service Coverage Ratio (DSCR) of 1.2 was assumed. The model was used to estimate the tariff at which project cash flows could meet the DSCR and provide an adequate return to project sponsors. The analysis estimated that a tariff of 6.95 ¢/kWh would be required to meet the DSCR and provide an after-tax equity IRR of 10%. Debt at 3.0% and a loan tenor of 18 years would lower the tariff to about 6.55 ¢/kWh.

The estimated tariffs are higher than that generally seen in global auctions for solar PV projects and need to be refined with detailed estimation of capital and operational costs and other model inputs, and in consultations with DFIs on proposed term sheets for a solar PV project in Kosovo. The development of an auction process with standardized contracts (as presently being supported by the EBRD) would also help lower the tariff. Risks associated with a long-term PPA with the off-taker KOSTT will need to be mitigated with risk instrument from DFIs and export credit agencies, which increases the cost of financing. Also, guarantees from DFIs generally require a sovereign guarantee from the government.

**Projects under the Authorization Procedure.** Financial analysis for a grid connected 3 MW solar PV system costing about 550 EUR/kW financed with 70% debt at 5% interest rate and 12-year loan tenor would have an IRR of 8% and DSCR of 1.26, at a tariff of 0.045 EUR cents/kWh. Debt terms, the tenor of the PPA, and the tariff all on the IRR and DSCR. Guarantee instruments to mitigate debt service, project termination and political risks would help lower the financing risk and improve project bankability through favorable terms for financing.

**Behind-the-meter projects.** Typical project size in this market segment varies significantly based on the customer segment. A model was used to analyze the impact of key variables – project cost, interest rate on debt, and tenor of loan – on the IRR of the project and ability to service debt. The analysis showed that for a household with a 5-kW rooftop solar PV system costing about 1,200 EUR/kW financed with 60% debt at 3% interest rate and 10-year loan tenor would have an IRR of 7% and DSCR of 1.2. A similar analysis on a typical 50-kW installation at a business costing about 800 EUR/kW financed with 70% debt at 7% interest rate and 8-year loan tenor would have an IRR of 11%

---

<sup>2</sup> KEK provided information on a feasibility study for a 50 MW Solar PV project (confidential). IRENA. 2020. Renewable Power Generation Costs in 2019, International Renewable Energy Agency, Abu Dhabi.

<sup>3</sup> The Cost of Renewable Energy Spreadsheet Tool (CREST) developed by the National Renewable Energy Laboratory (NREL), an agency of the US Department of Energy, was used to model the cash flows from the solar PV project. CREST is a cost-of-energy analysis tool that determines minimum revenue per unit of production needed for a project to meet investors minimum required after-tax IRR.

<sup>4</sup> The cost of risk mitigation instruments is not included and would need to be discussed with lenders and DFIs.

and DSCR of 1.1. A 400-kW solar PV installation costing about 700 EUR/kW financed at the same terms as the 50-kW installation would have an IRR of 15% and DSCR of 1.25. Project cost, interest rate and loan tenor all have an impact on the IRR and DSCR and targeted capital grants and/or exemption of VAT, and more favorable financing terms would make projects more financially attractive. Partial loan guarantees from KCGF can help banks offer favorable terms. Prosumers under the net-metering scheme could additionally benefit by selling excess electricity to the grid.

## FINANCING SOLAR PV PROJECTS

Financing mechanisms and options presently available for financing solar PV projects in each market segment in Kosovo is summarized below.

**Utility-scale grid connected projects.** Utility scale solar PV projects are yet to be developed in Kosovo. The wind farms developed and under development in Kosovo provide a guide to financing options for solar PV projects. A grid connected 32.4 MW wind farm (Kitka) was developed at a project cost of EUR 73 million, with the EBRD financing EUR 17.5 million.<sup>5</sup> A second wind farm – the 105 MW Bajgora wind farm – is presently under development with a EUR 58 million loan from EBRD and additional financing from Erste Group Bank and NLB Bank and cover provided by the German export credit agency (ECA) Euler Hermes.<sup>6</sup>

Developing utility-scale solar PV projects in Kosovo will very likely require guarantee instruments and debt financing from DFIs and local and foreign commercial banks, and equity from project sponsors. The IFC is seeking to advise the government of Kosovo on the procurement of 50 MW solar PV plant and provide financing to potential bidders. The EBRD is presently supporting Kosovo develop a reverse auctions mechanism to competitively procure RE projects and is preparing standardized contracts and project documents. KEK, the utility, is considering developing a 50 MW solar PV plant with financing from KfW and/or a potential grant from the EU.<sup>7</sup>

The U.S. International Development Finance Corporation (DFC) – a successor to US Overseas Private Investment Corporation (OPIC) and the US Development Credit Authority (DCA) – could also potentially provide equity, debt, political risk insurance, loan guarantees and other investment vehicles to projects.

**Projects under the Authorization Procedure.** Commercial banks in Kosovo could potentially finance such projects based on their normal corporate lending practices, which typically is balance-

---

<sup>5</sup> <https://www.ebrd.com/work-with-us/projects/psd/kitka-wind.html>. Air Energy SH.P.K is a special purpose vehicle (SPV) fully owned by Guris Insaat ve Muhendislik A.S, a company which is part of the Turkish engineering and construction conglomerate Guris Group. The wind farm is located in the Kamenica Municipality in Eastern Kosovo and became operational in October 2018. KOSTT has recently signed a connection agreement to expand the capacity of the wind farm by 20 MW, which is expected to be operational by 2022 (<https://www.evwind.es/2020/09/11/kosovo-signs-agreement-for-wind-energy-expansion/77127>).

<sup>6</sup> The Bajgora wind farm is being developed in the Mitrovica municipality by Sowi Kosovo LLC, which is majority-owned and controlled by Enlight Renewable Energy Ltd, an Israeli renewable energy company. The projects is scheduled for completion in April 2021. <https://www.ebrd.com/news/2019/575m-ebrd-loan-to-build-kosovos-biggest-wind-farm.html>

<sup>7</sup> KEK plans to develop a 100 MW solar PV at the ash dump Kosova A and waste dump “Dragodan”, and a preliminary project feasibility study has been prepared.

sheet based term loans. Local financing institutions (FIs)<sup>8</sup> could also form a syndicate to finance projects to avoid breaching regulations on single borrower limits. Local FIs partnering with KCGF could benefit from loan guarantees which presently provides a 50% guarantee on loans of up to 1.0 million EUR.<sup>9</sup>

**Behind-the-meter projects.** Projects in the agricultural sector have largely been financed by grants from the Ministry of Agriculture, Forestry and Rural Development (MAFRD) though these projects could also be financed by local FIs. Rooftop solar PV projects in households are generally financed through local FIs or self-financed. Local FIs provide retail loans based on their normal lending practices with some providing long tenor loans. For instance, Raiffeisen Bank finances 70% of the project cost up to 30,000 EUR with a loan tenor of up to 180 months, and average interest rate of 3.99%, which is favorable. Businesses can finance projects through local FIs including those that partner with KCGF.

EBRD's Green Economy Finance Facility (GEFF) provides supplementary financing to households and apartment buildings seeking financing from participating FIs. The facility provides loans of up to 50,000 EUR for households and up to 300,000 EUR for apartment buildings. These loans include a 15% grant component for one energy efficiency/RES measure and a 20% grant component for two or more energy efficiency/RES measures in households. The GEFF facility could be used to finance household solar PV projects. EBRD's Kosovo SME Competitiveness Support Programme provides loans through participating banks to businesses for solar PV installations up to 1.0 million EUR, with a 15% grant component.

## CHALLENGES TO FINANCING SOLAR PV PROJECTS

**Utility-scale grid connected projects.** A key challenge to financing large solar PV projects in Kosovo would be the risk premium on the cost of capital due to the political, policy, and off-taker risks perceived by lenders and project sponsors. Some of the principal financial risks of developing large solar PV projects include counter-party credit risk posed by the weak creditworthiness of public sector off-takers such as KOSTT, policy and political risks related to change in policies, taxes, royalties, etc. which may impact project revenues, and business interruption risks which may impact power generation and project revenues. Variable interest rate financing requires interest rate swaps but this can usually be mitigated by DFIs which provide fixed rate financing. Also, most DFIs can provide financing in Euros, the currency in Kosovo, which mitigates foreign exchange risks.

While DFIs have guarantee instruments to mitigate such risks, the GoK may have to indemnify the DFI through a sovereign guarantee in case the guarantee is invoked. A sovereign guarantee is a contingent liability for the government, which could limit its borrowing capacity. Guarantees without a counter guarantee would generally be more expensive. Regardless, guarantees add to the cost of financing the project and increase the tariff.

**Projects under Authorization Procedure.** A critical impediment to increasing installations (in the range of 1-5 MW) is the present uncertainty on the mechanism for establishing the energy price. The

---

<sup>8</sup> Local FIs include commercial banks, MFIs and a leasing company

<sup>9</sup> KCGF is developing a new guarantee window for energy efficiency and renewable energy, which is expected to provide a 50% guarantee on loans up to 2.5 million EUR (with guarantee amount up to 1.25 million EUR) and total project costs up to about 3.5 million EUR. The new facility is expected to be operational in 2021.

ERO board has decided to discontinue the FIT and is considering a reference price or tender price that is subject to change from year to year. Given that the bankability of these projects hinges on electricity sales to the grid, certainty in the pricing mechanism will be crucial to additional projects being developed under the Authorization Scheme. Tariff variability over the life of the PPA will also significantly impact financing for such projects.

Another key challenge to projects in this category is the absence of project finance options from local FIs. Local financing is generally based on balance-sheet lending with significant collateral requirements which limits the ability of developers to scaleup project installation. Project finance typically requires guarantees for payments against PPA obligations and for project termination and political risks. Local FIs also lack the capacity to evaluate projects based on project financing structures.

**Behind-the-meter projects.** Agricultural consumers are hesitant to take loans due to high interest rates and fees, short tenors, and collateral requirements. The availability of grants from MAFRD is also a disincentive to commercial financing. Commercial bank financing for households is based on retail lending practices which is dependent on income and not on energy cost savings from self-generation of electricity. This limits the ability of households to seek commercial financing. Rising electricity prices and falling equipment costs will improve project the bankability of projects. Another constraint to prosumer installations is the capacity limit of 100 kW imposed by the ERO, which businesses consider too low. Yet another drawback to prosumer installations is the onerous, lengthy application process to receive approval from the ERO, which can take a number of months. Presently, an engineer's certification is required to confirm that the roof can handle the load.

## **SUGGESTIONS FOR IMPROVING FINANCING OPTIONS FOR SOLAR PV PROJECTS**

**Utility scale grid-connected projects.** As noted above, financing large solar projects in Kosovo will likely need risk mitigation instruments from DFI. Apart from reducing risk, the inclusion of DFIs in the financing plan lowers the risks perceived by commercial lenders to the project and lowers the cost of financing and in turn lowers the tariff. The guarantees under the EBRD financed wind farms in Kosovo provide a guide to the cover required and the cost of the cover. Discussions with DFIs, commercial lenders, and the GoK on guarantees required is critical to scaling up investments in large solar PV projects. In Kosovo, public finance is perhaps best used to de-risk private investment and lower the risk premium through provision of sovereign guarantees.

A Letter of Credit (LC) from a commercial bank could be used to guarantee PPA payments from KOSTT for a period of three to six months. Amounts could also be held in escrow to cover PPA obligations. Optionally, a DFI could provide a guarantee to the LC issuing bank, with a sovereign counter guarantee from the government.

IFC is seeking to replicate its Scaling Solar program to support Kosovo develop solar PV projects. While the program would benefit Kosovo by developing standardized bid documents and project documents and agreements and provide stapled financing (essentially is a common financing term sheet provided to all eligible bidders), other DFIs including the EBRD may have different requirements and project documents, and this aspect needs to be discussed with the DFIs. The DFC could also provide debt and guarantees to projects but its appetite to participate in tendered project which may not include US investors or equipment for the project needs to be ascertained. A potential drawback to



DFC financing is that it provides LIBOR based US dollar financing, which will require incurring additional costs for a currency swap to mitigate currency risks since project cash flows would be in Euros. This aspect too needs to be discussed with DFC.

The potential to export power from Kosovo to regional countries, and the recent agreement to participate in the common electricity market could also help lower investment risks for project sponsors, and this aspect should be examined.<sup>10</sup>

**Projects under Authorization Procedure.** A decision by the ERO on the tariff mechanism will provide certainty to project developers. Development of standardized project contracts and documents along with guarantee instruments will improve the bankability of projects and help shift from balance-sheet lending to project finance, which can help scale up projects. KCGF's plans to improve the capacity of stakeholders will also support shift to project financing.

**Behind-the-meter projects.** Agro grant schemes could limit the percentage of grants provided to projects to stimulate the growth of commercial financing. Increased commercial financing will strengthen the knowledge and capacity of local FIs and could lead to provision of more favorable terms for lending. The increased use of KCGF guarantees would lower the cost of commercial financing. An exemption from VAT for household prosumer installations would decrease project costs by 20% and make installations more affordable and bankable. Long tenor financing and use of equipment as collateral would also incentivize increased lending. Decreasing prices for solar PV projects and increased electricity prices will also stimulate increased commercial financing. Standardized and streamlined procedures for municipal review and consent to projects would also help increase the number of installations.

## **NEXT STEP**

This report has developed suggestions to overcome challenges and improve the financing climate for the three principal market categories of solar PV projects in Kosovo. The next step is to develop financing mechanisms and instruments and explore policy options to address the challenges. This will require close interaction with stakeholders in the GoK, electricity sector institutions, DFIs, commercial banks, project developers and bilateral donors, including those already supporting RE projects in Kosovo. Given the disparate needs of the three market segments discussed in this report, it is recommended that separate work streams be developed to improve financing for each market segment.

---

<sup>10</sup> In 2020, Kosovo agreed with the association of European grid operators to connect with the continental European grid, allowing it to operationalize an under-used 400 kV interconnection with Albania.

## **BARRIERS AND RECOMMENDATIONS <sup>11</sup>**

The Annex 3 report is divided into four parts, each focused on a different functional topic, with a number of identified barriers and recommendations:

- Part I. Integration of renewable self-consumers;
- Part II. Large solar PV generators based on unsolicited procedures;
- Part III. Large solar PV generators based on forthcoming solicited procedures;
- Part IV. Other barriers.

### **INTEGRATION OF RENEWABLE SELF-CONSUMERS**

When discussing about renewable self-consumption it must be clearly noted that this segment is not recognized and assessed as an important sector for RE. The current policy framework does not emphasize or even point out any targets for renewable self-consumption. Beside the prosumer projects registered by ERO, the GoK does not keep any track of other projects which are used only for self-consumption and do not inject electricity into the grid. Hence, the GoK should clearly define renewable self-consumption targets in its national policy, including the NECP and the Energy Strategy. Moreover, it should establish the legal basis for keeping track of self-consumption projects and incorporate such projects towards its national RES targets. In the meantime, GoK must ensure to develop the secondary legislation to formally establish a roadmap for monitoring and reporting of key performance indicators for implementation of renewable self-consumption targets.

The right to renewables self-consumption is not recognized in the primary legislation and only secondary legislation makes a partial reference to it. Hence Kosovo should either adopt a Law on Renewable Energy Source or amend its Law on Energy to include renewables self-consumption, including the right to store energy, beside the right to produce and inject the excess electricity. Current restrictions on prosumer status to 100 kW and low voltage grid connection should be eliminated as they discriminate arbitrarily towards other final customers.

The power sector would benefit from adoption of a law on renewable energy sources, with a specific section on self-consumption and include in a clear and simplified manner all the mechanisms and the applicable conditions, including net-metering, net-billing with pricing mechanisms, connection to the grid, etc. Introducing the jointly acting renewable self-consumers in such law would assist multi-apartment buildings to switch to renewable self-consumption, which would in turn enhance energy efficiency and contribute to RES targets. Peer-to-peer trading and aggregation should be explicitly recognized in the primary law.

From a technical and technological point of view, Kosovo's energy sector does not face limitations when it comes to the installation of all types of renewable technologies by self-consumers connected to the grid with net metering. Moreover, there are no legal and regulatory obstacles for installation of energy storage for RE self-consumers, however the energy law is silent in relation to self-consumption and the existing rules adopted by ERO do not cover operation and storage for self-consumption.

Network planning is undoubtedly a cornerstone for any future reliable development, and as such, it is crucial for the network development plan to consider RE self-consumers demand, which is not the case in the existing KEDS development plan 2020-2029. It is, therefore, imperative to work on

---

<sup>11</sup> This is a summary of the main identified barriers and recommendations. A detailed description is provided in Annex 3 Report.

identification of potential sites for self-consumers and relevant planning in accordance with TSO and DSO development plans. In addition, potential self-consumers should have full access to information concerning the network development plans and potential available capacities for their RES deployment. In terms of smart metering systems for self-consumers there is a need to further develop and enhance the regulation for such a system pursuant to the Policy Guidelines of the Energy Community, which among others, shall clearly address costs and installation of smart meter by the prosumers. The current DSO's connection procedures are complicated and should be streamlined and simplified. Draft DSO's Connection Charging Methodology is under review by ERO.

With regards to the support schemes, the only applicable scheme for renewable electricity self-consumption in Kosovo is net-metering (two-way metering). With net-metering, the amount of energy consumed from the grid is balanced annually with the amount supplied back to the grid from excess renewable energy production. Any outstanding positive balance on the last billing period of a calendar year is reset to zero (0 kWh) without compensation from the supplier. However, the excess renewable energy produced (for example, during the day with solar PV) helps offset energy bought from the grid (for example, at night).

Net-metering is used widely worldwide. However, it often involves offsetting consumption with excess production on a kWh basis but not on a market price base for the transfer of electricity to the grid. The EU Energy Acquis requires that in order not to distort the market, more market-oriented mechanisms need to be used, with market prices paid both by the consumer for electricity bought and by the utility for electricity transferred to the grid by the consumer. Therefore, it is proposed that net-metering be used only for small-scale renewable self-consumption where the vast majority of electricity produced by RES is self-consumed by the consumer, and the net transfer of electricity to the grid is minimal.

Currently, in Kosovo, net-metering is authorized only for installations up to 100kW and connected to low voltage 0.4 kV network, and with an obligation on the universal supplier to conclude a prosumer agreement with the final customer, who also are in the balance group of the supplier. However, the legislation does not define the initial phase and the tenor for the net-metering authorization.

Net metering should continue to apply for certain self-consumers, such as household and SMEs that transfer only small net amounts of electricity to the grid. Ideally, Kosovo would transition from net-metering only to net-billing, where electricity is bought and sold for respective tariffs. Kosovo has not yet implemented net-billing, but it may be proposed in the National Energy Climate Plan (NECP). It should be pointed out that Kosovo has never conducted a country-specific study to assess each potential support mechanism, examine how they may incentivize increased RES installation to help achieve the country's targets, and estimate the fiscal implications of such mechanisms to households, businesses, and the national budget. Net-metering and net-billing self-consumers should be allowed to install capacities up to 400kW (up from the current 100kW cap) without having responsibility for balancing, as stated in the EC Directive. Installations over 400kW should take responsibility for balancing. The ERO should then amend its Rules in order to harmonize them with the primary legislation.

Final consumers are not sufficiently informed on RE self-consumption scheme, accessibility and their rights and benefits as self-consumers. This is particularly applicable to KEDS and KESCO which do not publish any information in that respect. KESCO as a public supplier, and other suppliers, shall use all accessible means to inform consumers on their rights and responsibilities in relation to self-consumption, such as to use: information campaign, leaflets submitted to consumers together with their monthly invoices, web site information and through media.

Renewables prosumers are not exempted from any charges or taxes. Prosumers pay the entire VAT amount of 18% for the PV solar system equipment, including project development and installation. The only reduced VAT is for electricity consumption amounting to 8%, however, this reduction is applied for all customers in Kosovo. In connection to the VAT on the PV solar system, the in-field research

has shown that this is a barrier to installation, especially in the household sector. An exemption from VAT would incentivize increased household installation of renewable self-generation. An in-depth study on the fiscal implications of reducing or eliminating VAT is required. Similarly, there is a lack of studies on fiscal impacts of mechanisms like netting schemes. Policy and legislative changes cannot be judiciously made without undertaking Kosovo-specific studies.

Lastly, it is important to promote and foster self-consumption by households and small commercial consumers by not applying charges, taxes and levies, especially when the generated energy is for self-consumption and not injected into the grid. Any charges, taxes and levies applied should be for specific grid services and clearly defined.

Key recommendations:

- Introduce New Law on RES or Amend the Law on Energy No. 05/L – 081 (June 2016)
- Increase connection voltage level from current Low Voltage (0.4 kV) to Medium Voltage (10, 20, 35 kV)
- Increase capacity of Prosumer installation from current 100 kW to e.g. 400 kW
- Introduce reporting requirements for behind-the-meter installations to account for CO<sub>2</sub> offset
- Increase awareness of customers on Prosumer procedures and benefits
- Simplify and standardize the authorization process and forms:
- Minimum charges, taxes and levies for authorization and approvals.

## **LARGE SOLAR PV GENERATORS BASED ON UNSOLICITED PROCEDURES**

This part describes the barriers identified by businesses which developed and implemented large scale projects, previously supported by feed-in-tariff.

The main obstacle identified with regards to unsolicited generators is the lack of harmonization of different legal acts and the complexity of the process which impacts investors in the process of receiving authorization to construct RES installations. For example, while the PPA for solar PV projects is for 12 years, the environmental permit for operation, in accordance with the Law on Environmental Protection, is issued only for a five-year period. The duration of the environmental permit should be extended to match the tenor of the PPA.

The PPA is not guaranteed by the government (both on the payment for energy and on stability of the pricing methodology and regulatory framework), which inhibits lending to the project on a non-recourse basis. All the businesses interviewed during October – November 2020 have reported that they had fundamental problems in obtaining the grid connections with KEDS. In addition, they felt that KEDS' charges were unreasonably high.

In case a municipal consent is requested there are no standardized forms, and each municipality uses different ones. In order to avoid delays in obtaining municipal consent there should be one single form applicable in all the municipalities and be accessible online through the municipal website. Additionally, the business community noted that municipal personnel are often inadequately trained and not sufficiently experienced to assist investors in the administrative process of obtaining licenses, permits and other approvals. Capacity building and training programs should be offered for municipal staff so that they benefit from the best practices and support investors.

The businesses have further reported many delays in obtaining documentary evidence from different national institutions, in order to then be able to apply for authorization at ERO. Hence, in order to keep a correct track of the duration of the authorization procedure, ERO must track the entire

duration it takes the investors in order to gather all the documentary evidence before applying to the Regulator.

Until recently the main applicable support scheme for RES generators was the feed-in tariff. The Energy Regulatory Office (ERO) at its Board meeting in December 2020 issued a decision to terminate feed-in tariffs. The ERO, however, did not decide which pricing mechanism will replace the feed-in tariffs, and has therefore left the entire process in limbo. This uncertainty has brought the entire process to a halt. The draft methodology for reference prices for RES generators is still not adopted and there is no reference price set by the ERO for the year 2021. This prevents potential generators from applying for RES installations. The ERO needs to adopt a pricing methodology for RES generators for 2021 that allows for cost recovery and reasonable return on investment.

For the grid to accommodate significant new additional RES, it may be necessary to install energy storage in order to stabilize the grid operations. Currently no procedure or policy exists to address energy storage. Both KEDS and KOSTT have stated that adequate reserves, balancing mechanism and auxiliary services are not currently available. This is important for the development of large-scale RES generators<sup>13</sup> that are primarily selling to the grid. The ERO and the DSO need to develop policies and procedures for energy storage such as utility scale battery storage (BESS), and develop a market for ancillary services to facilitate integration of large-scale RES into the grid.

Current TSO development plans do not consider potential sites and capacities for new RES development. Network planning studies are also not available to project developers. This could lead to inoptimal planning and high costs for connecting new RES into the grid. Siting and sizing of new solar PV/RES should be coordinated with TSO and DSO expansion plans. Project developers should be provided information on generation and transmission expansion plans developed by the utilities and/or market operator.

Key recommendations:

- Power Purchase Agreement (PPA) to be guaranteed by the government – supportive of lending to the project on a non-recourse basis.
- Adopt Methodology for Connection (pricing) as KEDS' charges were unreasonably high.
- Introduce new pricing mechanism to replace Feed-in-Tariffs (terminated as of December 2020)
- Adopt methodology for reference prices for RES for 'Regulated Framework' projects

## **LARGE SOLAR PV GENERATORS BASED ON SOLICITED PROCEDURES (TENDER OR AUCTION)**

Large utility scale solar PV projects above 3 MW are yet to be developed in Kosovo. The solicited competitive and transparent bidding processes are necessary for increasing investors' confidence and inviting credit project sponsors interest and submissions.

Financing large solar PV projects in Kosovo is a process facing the political, policy, and off-taker risks perceived by lenders and project sponsors. Such barriers have impact on the increase of the risk premium on the cost of capital, making the project more expensive and increase the tariff. Key risks include counter-party credit risk posed by the weak credit worthiness of public sector off-takers such as KOSTT, policy and political risks related to change in policies, taxes, royalties, electricity prices, etc. which may impact project revenues, and business interruption risks which may impact power generation and project revenues. Variable interest rates and non-Euro financing could also be a risk depending on the lenders to the project. Hence, a number of measures can take place to mitigate these risks. For instance, inclusion of DFIs in the financing syndicate helps lower the perception of risk and crowds in commercial financing. Risk mitigation instruments from DFI and other instruments from Export Credit Agencies, and commercial insurance should be explored to mitigate project risks. GoK should consider the need to provide sovereign counter guarantees to guarantee instruments provided

by DFIs. An analysis of the total amount of counter guarantees that GoK can provide to large RE projects should be undertaken. Liquidity guarantee through Letters of Credit from banks should be considered to guarantee PPA payments from KOSTT for a period of three to six months. Escrow accounts to cover PPA obligations should also be considered. The potential to export power from Kosovo to regional countries, and the recent agreement to participate in the common electricity market should be examined since it reduces the dependence on a single off-taker.

The terms and conditions of the PPA, the implementation and grid connection agreements and contracts will be critical to the bankability of projects, and project risks will need to be mitigated with appropriate instruments. Hence it is recommended that Standardized project documents should be developed to procure energy competitively and transparently from large solar PV projects. Document should be of internationally accepted standards and should be developed in consultation with all stakeholders.

Key recommendations:

- Use of competitive and transparent bidding processes (tendering / auctions)
- Standardize terms and conditions of the PPA, Grid Connection Agreement, and other project agreements such as Land Lease Agreement.

## **OTHER BARRIERS**

This part focuses on other barriers that impact all generators of the RES sector in general. Most of the obstacles covered in this part are related to non-implementation of already adopted laws and regulations or inadequate secondary regulations and policies.

An identified barrier impeding the expansion of the prosumer segment is the illegal status of 350,000 buildings throughout Kosovo. As long as a building is illegal it means it lacks a construction permit which is one of the main documents to submit in order to receive the municipal permit for installing a photovoltaic system. The national authorities should take note of this matter and address it accordingly.

Another barrier is the limited use of public tendering processes for RES generation capacities. That is, the current authorization procedure administered by ERO has not resulted in sufficient RES generation capacity to ensure national security of supply, hence, in accordance with Article 44 of the Law No. 05/L-084 on Energy Regulator, ERO needs to issue a written decision recognizing this state, and then the government can launch tenders. It is recommended that the tendering process is used to fulfill the 20MW additional solar PV target as provided in the Administrative Instruction No. 05/2017 on Renewable Energy Sources Targets. In general tendering processes as recognized in the national law shall be utilized by the GoK in order to shift towards market-oriented mechanisms for RES support which would be in compliance with the recommendations of the EnCS and in accordance with State Aid rules.

With regards to simplified and streamlined procedures even though the One Stop shop is established and is also functional, yet this institution has not played any active role thus far nor has it undertaken any activities.<sup>12</sup> One Stop Shop should be an active and key player in facilitating and promoting RES in Kosovo, with constant operational offices and known to the business community.

---

<sup>12</sup> Metal Industry and Renewable Energy Cluster of Kosovo (MIRECK) , “Electronic communication between representatives of MIRECK and Bashkim Pllana (One-Stop-Shop)”, 13 August 2020.

Related to the grid access, all the businesses that applied for connection of new RES generation capacities have reported fundamental problems with KEDS with regards to connection to the grid. In certain occasions KEDS has attempted to reject the requests for connections and proposing connection through transmission system network, while in economic and technical terms these installations are suitable for connection to the distribution network. Moreover, KEDS has obliged renewable energy businesses to perform deep connection, including construction of kilometers of overhead line, which is not technically and commercially feasible. The investments done by the investors are of tremendous value and not all of them are necessary. It is recommended that ERO reviews technical requirements imposed by KEDS on investors and evaluates if these requirements are applied in a transparent, non-discriminatory, and proportional manner. Regular monitoring by ERO shall ensure that also the RE-self-consumers are not charged in access and in disproportional manner. ERO shall adopt the draft connection methodology.

Moreover, ERO should consider the reasons why its Board has to approve each and every request for prosumers status. As in other CPs of the EnC, the prosumer status can be obtained through the DSO, however, the latter shall be obliged to register all prosumers and keep record of each installation and inform ERO on each granted status.

Lastly, but very important is the implementation of the certificate of origins. Even though there is a rule adopted by ERO in 2010, yet this system is not fully functional as the rule needs to be amended and an electronic system for issuing, transfer and cancellation of guarantees of origin compatible with the standardized European Energy Certificate System needs to be implemented.

Key recommendations:

- Higher utilization of the One Stop Shop (OSS) for RES projects;
- Establish certificate of origin register and issue electronic certificates
- Simplified procedure in all institutions involved in granting licenses or permits
- Improve local legislation compliance with EU Directives
- Remove RE targets from Law on Energy to avoid frequent need for amendment.

## **GENDER INCLUSION, EDUCATION AND JOB OPPORTUNITIES IN RES/ PV SOLAR SECTOR IN KOSOVO**

This part summarizes findings of Annex 2 report section on job potential, education and gender inclusion.

### **JOB OPPORTUNITIES**

#### **Current employment situation:**

- Solar Business is relatively new in Kosovo with 15 active companies in solar PV installation, with 5 companies focused exclusively focusing on PV solar business and are considered main market share competitors.
- Average number of regular employees at these companies is between 14-25; Depending on dynamics of projects these companies hire short-term technician / installers.
- Average installed capacity of PV Solar panels for each company to date varies between 0.65 – 1.7 MW
- A solar PV assembly plant in Kosovo has 50 regular employees in production PV Solar line (50% men, 50% women); 20-27 Age group, and about 20 regular installers.

#### **New job opportunities:**

- The future solar PV projects pipeline over next 10-year period is expected to generate enormous demand for solar PV experts and labor for installation works.
- The Prosumer and Agricultural grant are two segments that will see the largest number of installation (~ 13,000).
- The estimated number of new long-term direct jobs is between 1,500 and 2,000.

#### **Challenges:**

- Lack of skilled, trained and experienced staff in RES and solar PV project implementation.
- Lack of public awareness raising on career orientation and job opportunities in RES and solar sector.
- Weak education programs – mismatch of education curricula / programs with market needs.

### **EDUCATION**

#### **Current education offering relevant to RES:**

- University of Prishtina (UP):
  - Faculty of Mechanical Engineering: Study programs in RES (BSc and MSc) – 350 students currently attending studies in both BSc and MSc; 20 graduates per year in BSc and 5-7 in MSc; 60% women, 40 % male students.
  - Faculty of Architecture: Study program (MA) in Energy Efficiency in Public and Resident buildings, in cooperation with QEQ
  - Faculty of Electrical and Computer Engineering: Only one module
  - Center for Energy and Sustainability (QEQ): Certified program courses in RES including Solar energy (20 ECTS)
- University for Business and Technology (UBT): Study programs in RES (BSc and MSc) – 100 students currently attending BSc studies and 20 in MSc; 80 % male, 20% women students.
- American University in Kosovo (AUK/RIT): offers only one module in RES energy and solar energy
- VET & Technical Schools – No specific program in RES, programs on electric installations; 400 students per school (88% boys, 12% girls), can be good future potential for solar installations
- KEK training center – provides certified training programs in Electricity, Mechanical operation, Welding, Safety at work and Management, can expand to RES and Solar training



Center (perhaps incubator for Solar) for existing KEK staff in transition to renewable (solar) energy and external candidates.

- KEDS Academy – provides training and employment opportunities for students from VET schools and universities
- AWESK – association of approx. 130 women experts in energy field providing mentorship, projects, trainings.
- KIMERK / SHERK - Association of RES companies - provides trainings, employment mediator, business partnerships, mentorship.

### **Challenges in RES education:**

- Public Universities:
  - Miss match of study programs in RES and solar energy with market demands and developments
  - Lack of laboratories and software for practical demonstration
  - Lack of partnership with RES and solar industry
  - Lack of career orientation sessions in RES, mentorship programs, internship programs
  - Lack of exchange study opportunities with international universities in RES and solar energy.
- Vocational and Education Training (VET) and Technical schools:
  - Lack of skilled technicians in RES
  - Lack of job profile and curricula at school programs in RES and Solar energy
  - Lack of trained teachers/trainers
  - lack of facilities & equipment in RES and solar energy.

### **GENDER INCLUSION**

- Energy sector in Kosovo is not gender neutral yet, where women inclusion is less than 10%
- None of the Kosovo Laws, policies or strategies in energy sector are gender sensitive, despite the EU call for gender mainstreaming in energy sector and as per Kosovo Law on Gender Equality (LGE) as a prerequisite for EU pre-accession process
- There is lack of consolidated data on women inclusion in energy sector as per their specific occupations in respective energy institutions, agencies, companies
- There are some measures and initiatives taken for women inclusion in specific energy related entities, including RES projects and access to grant programs by both government and donor support but there is no sustainable nor institutionalized approach to systematic gender mainstreaming in all segments of energy sectors.
- No sufficient utilization and inclusion of AWESK capacities in various institutional and donor women related matters in energy sector.

Some figures on women inclusion in Kosovo RES and Solar sector:

- Education: PU (60% F; 40% M); UBT(80% M; 20% F); VET and technical schools (88% M; 12% F); MCC: 22 Scholarships for women for MA study programs in RES in international universities
- Employment in PV Solar companies: 12-15% F (mainly in project development and management, administration and finances; 85% M (mainly in installation of PV Solar panels)
- Factory/Manufactory of PV Solar panels – 50% F; 50% M (production line); 100% M in installation of PV Solar panels
- AWESK – Association of Women in Energy Sector in Kosovo – 100% F (51 Certified women in energy related fields, including RES, Energy Efficiency and Saving and Energy Tariffs).

**U.S. Agency for International Development/Country**

Office Address Optional

**[www.usaid.gov](http://www.usaid.gov)**



# KOSOVO ENERGY SECURITY OF SUPPLY

JO 27: ASSESSMENT OF PV GENERATORS IN KOSOVO

ANNEX I – STATUS OF PV DEPLOYMENT IN KOSOVO

December 2020

This publication was produced for review by the United States Agency for International Development. It was prepared by DT Global.

# KOSOVO ENERGY SECURITY OF SUPPLY (KESS)

## JOB ORDER KESS – 027 ASSESSMENT OF PV GENERATORS IN KOSOVO

### ANNEX I – STATUS OF PV DEPLOYMENT IN KOSOVO

**Contract No:**

AID-167-C-17-00004

**Submitted to:**

USAID Kosovo

**Prepared by:**

DT Global

**Photo Caption:**

Solar PV park in Gjakova. Photo credits: KESS

**DISCLAIMER:**

The authors' views expressed in this document do not necessarily reflect the views of the United States Agency for International Development or the United States Government.

# CONTENTS

<b>Figures</b> .....	<b>v</b>
<b>Tables</b> .....	<b>vi</b>
<b>Abbreviations</b> .....	<b>vii</b>
<b>Introduction</b> .....	<b>1</b>
<b>Solar energy as renewable energy source in Kosovo</b> .....	<b>2</b>
Solar power potential in Kosovo.....	2
Types of PV generators.....	4
Large solar PV generators.....	4
Prosumers (Self-consumption Generators).....	4
Behind-the-meter PV installations.....	5
Off-grid solar PV.....	6
<b>Legal, Policy and Regulatory Framework for PV Projects in Kosovo</b> .....	<b>7</b>
International Energy Legal Framework relevant to Kosovo.....	7
Energy Community Treaty.....	7
Renewable Energy Sources (RES) Directive 2009/28/EC.....	7
Clean energy for all Europeans.....	8
EU Directive 2018/2001 on the Promotion of the use of energy from RES.....	9
Guidelines on State Aid for environmental protection and energy.....	10
Policy Guidelines by the Energy Community Secretariat on the Integration of Renewables self-consumers.....	10
Kosovo Energy Strategy and RES Policy.....	13
Kosovo Energy Strategy.....	13
Energy Strategy Implementation Plan.....	13
National RES Action Plan (NREAP) 2013.....	14
Administrative Instruction on Use and Support of Energy Generation from Renewable Sources.....	15
Administrative Instruction on Establishment of RES mandatory targets.....	15
Kosovo Laws applicable for PV Projects.....	16
Law on Energy No. 05/L-081.....	16
Law on Electricity 05/L-084.....	17
Law on the Energy Regulator No. 05/L-084.....	17
Law on Strategic Investments No. 05/L-079.....	18
Law on Public Private Partnership.....	18
Energy Regulatory Rules.....	19
Rule on Authorization Procedure for construction of new generation capacities from RES.....	19
Rule on Support Scheme.....	20
Feed-in Tariffs.....	21

Self-Consumption Generators.....	21
Regulated Framework.....	22
Renewable Energy Fund .....	23
Other relevant rules .....	24
Kosovo Fiscal Policy for RES / PV.....	25
Value Added Tax (VAT).....	25
Customs.....	25
Institutional Framework.....	27
Key Electricity Market Participants .....	27
Key Public Entities .....	28
<b>Administrative Procedures for PV project Development.....</b>	<b>32</b>
Authorization Process .....	32
Self-consumption Generators (Prosumers).....	36
Phase 1 – Authorization for Construction.....	36
Phase 2 – Admission to Support Scheme .....	36
Self-consumption Generators that do not feed to the grid .....	40
<b>Status of PV deployment in Kosovo .....</b>	<b>41</b>
Projects based on Authorization Process and Feed-in Tariff.....	42
FiT PV Projects in Operation.....	42
Prosumers (Self-consumption Generators) Installations .....	50
Behind the Meter Installations.....	53
Solar PV trends in Kosovo 2013 – 2020.....	56
Market share based on project types .....	56
Market share based on Solar Panels country of origin.....	57
Trends of solar PV project based on Solar Cell Type .....	59
Solar PV projects by installation.....	60
<b>PV Sector perceptions and experiences .....</b>	<b>61</b>

## FIGURES

Figure 1 Long-term average photovoltaic power potential (PVOUT).....	2
Figure 2 PV power output (PVOUT) in Kosovo.....	3
Figure 3 Distribution of photovoltaic power output.....	3
Figure 4 Large solar PV generator.....	4
Figure 5 Business with status of a Prosumer and solar PV installation.....	4
Figure 6 Household with a status of a Prosumer and solar PV installation.....	5
Figure 7 Business customer with Behind-the-meter solar PV installation.....	5
Figure 8 Behind-the-meter generator.....	6
Figure 9 Off-grid solar PV generator in agriculture.....	6
Figure 10 Process Chart for Authorization Procedure.....	34
Figure 11 Process Chart for Authorization for construction and Admission of Self-consuming generators to the Support Scheme.....	37
Figure 12 Albi Mall 500 kW behind the meter solar PV installation.....	40
Figure 13 Installed PV capacity in Kosovo during period 2013 – 2020.....	41
Figure 14 Number of installed FiT PV projects and capacity during period 2015 - 2019.....	42
Figure 15 Location of FIT PV projects in operation.....	43
Figure 16 Solar PV installations in operation based on FiT by municipality.....	43
Figure 17 Gjurgjevik, Klinë, 102 kW Solar PV based on Feed-in Tariffs.....	44
Figure 18 ONIX Spa, Banja e Pejës, Istog, 500 kW Solar PV based on Feed-in Tariffs.....	45
Figure 19 Eco Park, Madanaj- Kusar, Gjakovë, 3,000 kW Solar PV based on Feed-in Tariff.....	46
Figure 20 Frigo Food Kosovë, Madanaj-Kusar, Gjakovë, 3,000 kW Solar PV based on Feed-in Tariff.....	47
Figure 21 Eling, Llabjan, Pejë, 480 kW Solar PV based on Feed-in Tariffs.....	48
Figure 22 Solar Green Energy, Novosellë, Kamenicë , 3,000 kW Solar PV based on Feed-in Tariffs.....	49
Figure 23 Number and capacity of Prosumer installations 2018 - 2020.....	50
Figure 24 Allocation of main types of activity by existing Prosumers.....	50
Figure 25 Location of Prosumer projects in operation.....	51
Figure 26 Installed Prosumer capacity by municipality.....	51
Figure 27 List of Authorized Prosumers and their installed capacity.....	52
Figure 28 Off-grid solar PV installations: (left) Zajqevc apple tree plantation, and Frutomania processing facility (right).....	53
Figure 29 Number and capacity of Behind-the-meter installations 2013 - 2020.....	54
Figure 30 Share of installed capacity of Behind-the-meter by sector.....	54
Figure 31 Location of Behind-the-meter projects in operation.....	55
Figure 32 Installed Behind-the-meter capacity by municipality.....	55
Figure 33 Kosovo solar PV market share based on type of projects / installed capacity.....	56

Figure 34 Kosovo solar PV market share based on type of projects / installed capacity.....	56
Figure 35 Kosovo solar PV market share based on type and number of projects.....	56
Figure 36 Market share based on origin of solar panels per installed capacity.....	57
Figure 37 Market share based on origin of solar panels per number of projects.....	57
Figure 38 Market share based on origin of solar panels for FiT PV projects.....	58
Figure 39 Market share based on origin of solar panels per installed capacity of Prosumer projects.....	58
Figure 40 Market share based on origin of solar panels per installed capacity of Behind-the-meter projects.....	58
Figure 41 Trend of solar cell types thought years / per installed capacity.....	59
Figure 42 Trend of solar cell types thought years / per installed projects.....	59
Figure 43 Solar PV projects by type of rack installation.....	60
Figure 44 Solar PV projects by type of racks.....	60

## **TABLES**

Table 1 Recommendation Sets of Policy Guidelines on the Integration of Renewables Self-Consumers.....	12
Table 2 National overall targets for the share of energy from RES by 2020.....	14
Table 3 Measures for increasing PV utilization in accordance with NREAP 2013.....	15
Table 4 categories of power generation facilities.....	16
Table 5 Level of Feed in Tariffs set for Renewable Energy Sources.....	21
Table 6 List of Documents for Preliminary Authorization (Appendix I of the Rule).....	33
Table 7 List of Documents for Final Authorization (Appendix I of the Rule).....	33
Table 8 List of documents required to obtain other relevant consents, permits, and licenses.....	35
Table 9 List of Documents for Authorization of Self-consuming generators (Prosumers).....	38
Table 10 List of documents required for admission to the Support Scheme.....	39



## ABBREVIATIONS

AI	Administrative Instruction
CEFTA	Central European Free Trade Agreement
CEP	Clean Energy for all Europeans Package
CP	Contracting Party of the Energy Community Treaty
DSO	Distribution System Operator
EC	European Council
EnC	Energy Community
EnCT	Energy Community Treaty
ERO	Energy Regulatory Office
EU	European Union
FiT	Feed-in Tariff
GoK	Government of Kosovo
KEDS	Kosovo Energy Distribution Services
KESCO	Kosovo Company for Supply of Energy
KESS	Kosovo Energy Security of Supply (A USAID project implemented by DT Global)
KIESA	Kosovo Investments and Enterprise Support Agency
KOSTT	Transmission, System and Market Operator of the Republic of Kosovo
Ktoe	kiloton of oil equivalent
kW	kilowatts (capacity)
kWh	kilowatthours (energy)
MAFRD	Ministry of Agriculture, Forestry and Rural Development
MED	Ministry of Economic Development (now part of MEE)
MEE	Ministry of Economy and Environment
MESP	Ministry of Environment and Spatial Planning (now part of MEE)
MF	Ministry of Finance
MO	Market Operator, electricity
MTI	Ministry of Trade and Industry
NECP	National Energy and Climate Plan(s)
NREAP	National Renewable Energy Action Plan
PPA	Power Purchase Agreement
PPP	Public Private Partnership
PV	Photovoltaics
RES	Renewable Energy Source(s)
TSO	Transmission System Operator
USAID	United States Agency for International Development
VAT	Value Added Tax

## INTRODUCTION

This Annex I is first of three annex reports that are an integral part of the Summary Report of KESS Job Order No. 27 – Assessment of PV generators in Kosovo.

The main purpose of this Annex I report is to provide a detailed description on status of PV deployment in Kosovo by end of year 2020, by summarizing concrete results and achievements of policy, legal, and regulatory framework currently in force.

The findings of this report recapitulate what is to be considered a starting point for a more intensive and progressive utilization of solar energy as renewable energy source, supporting Kosovo in meeting development objectives by greater diversification and decarbonization of power sector, contributing to security of energy supply and creation of new sustainable “green” jobs.

This Annex I report is organized in following sections:

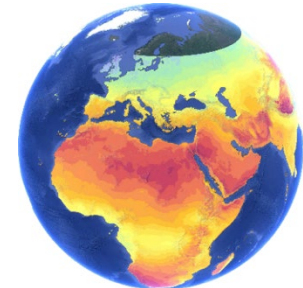
- **Section 1 – Solar Energy and Renewable Energy Source in Kosovo:** describes key definitions of solar energy and power and provides solar photovoltaics (PV) potential in Kosovo based on data from Global Solar Atlas. This section also describes typical types of solar PV projects as definition in Kosovo’s legal and regulatory framework in force.
- **Section 2 – Legal, Policy and Regulatory Framework for PV projects in Kosovo:** describes Kosovo’s international obligations, current policy and strategy, legal and regulatory framework for renewable energy sources (RES) with particular focus on solar photovoltaics (PV) projects development.
- **Section 3 - Administrative Procedures for PV project Development:** describes in more depth the application procedure and required supporting documents for developers to obtain the authorization for construction of new photovoltaic generation capacities.
- **Section 4 - Status of PV deployment in Kosovo:** describes the outcomes and concrete results of policy, legal and regulatory framework by summarizing all solar PV projects implemented by end of 2020 in Kosovo.
- **Section 5 - PV Sector perceptions and experiences:** summarizes private sector perceptions and experiences faced with current legal, regulatory, and institutional framework, while developing and constructing new solar PV generation capacities.

While Annex I report is retrospective and builds on experiences to date, the Annex 2 and Annex 3 reports are forward looking and provide outlook of future solar PV projects as well as set of recommendations for improving enabling environment where solar PV can have significant share in final electricity consumption in comparison to the current insignificant share of 0.04%.

## SOLAR ENERGY AS RENEWABLE ENERGY SOURCE IN KOSOVO

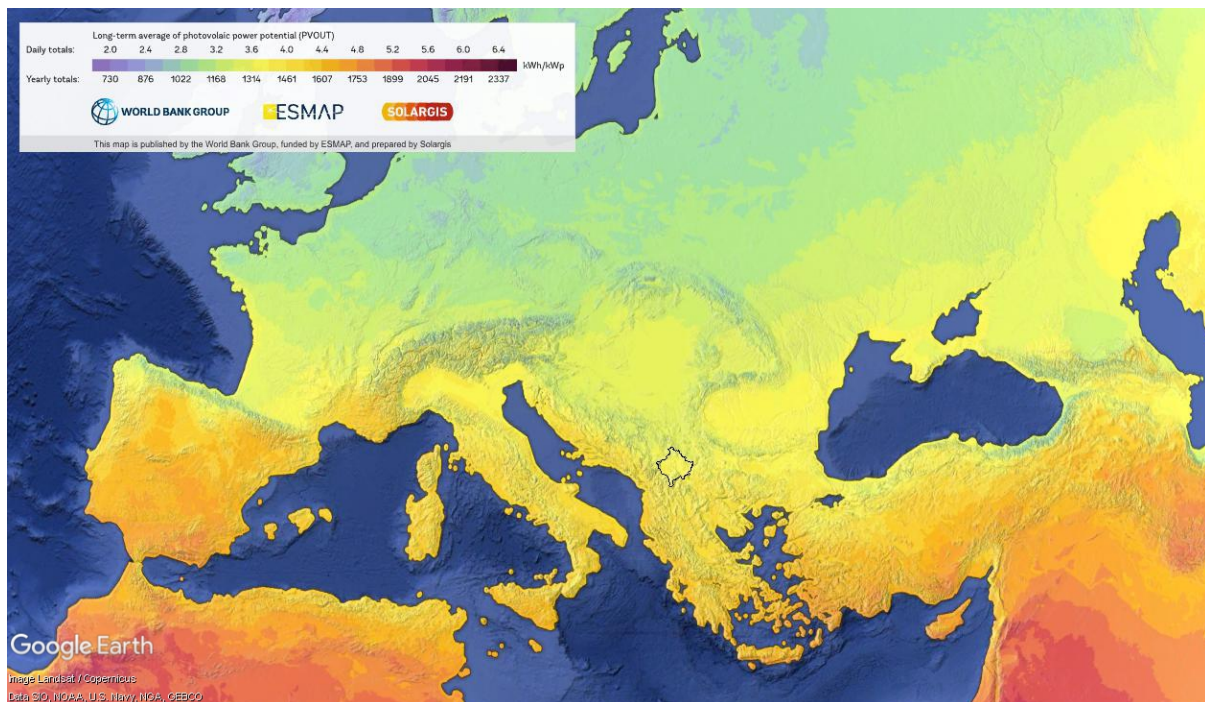
Solar energy is radiant light and heat from the Sun that is harnessed using a range of ever-evolving technologies. Solar power is the conversion of sunlight into electricity. In this report we focus on utilization of solar energy by direct conversion of light into electricity using the photoelectric effect (photovoltaics) of the solar cells installed on solar panels.

The potential solar energy that could be utilized differs from the amount of solar energy present near the surface of the planet due to factors such as geography, time variation, cloud cover, and the land availability, which limit the amount of solar energy that we can acquire.



Geography affects solar energy potential because areas that are closer to the equator have a higher amount of solar radiation.

Time variation also effects the potential of solar energy because during the nighttime, there is little solar radiation on the surface of the Earth for solar panels to absorb. This limits the amount of energy that solar panels can absorb in one day, and this resource is therefore considered to be intermittent.



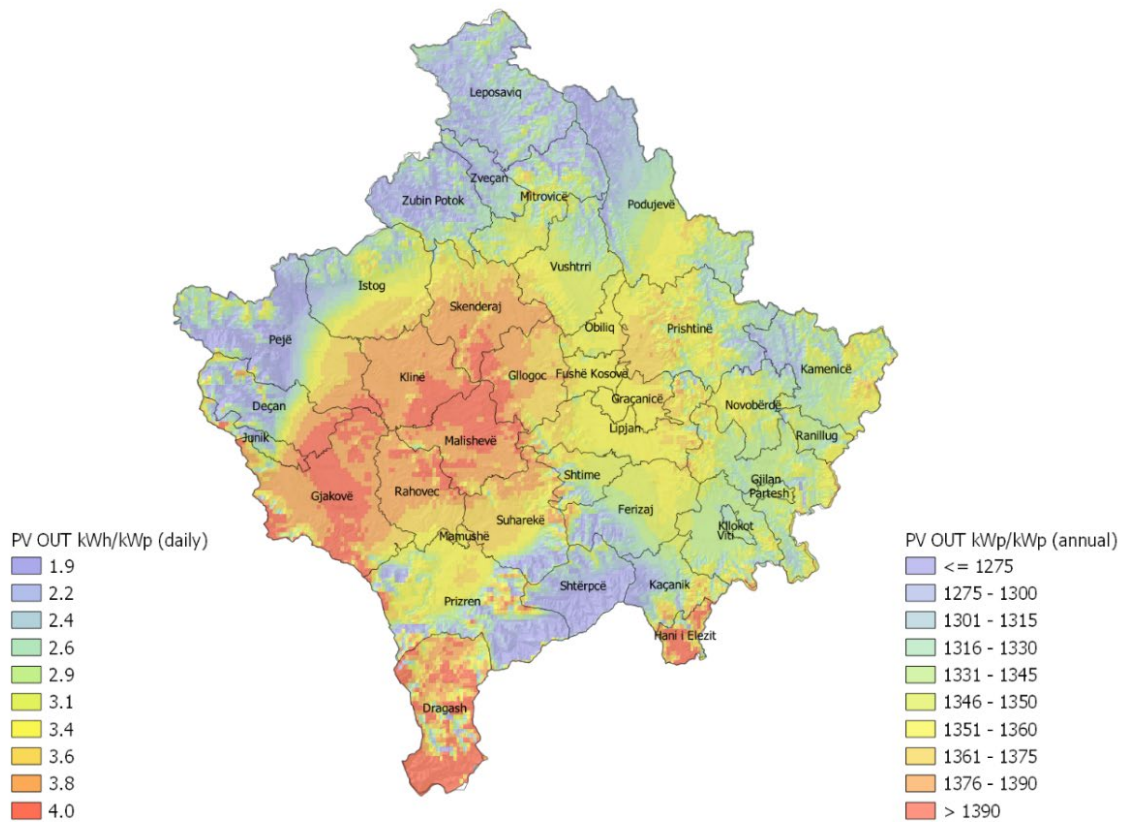
**Figure 1 Long-term average photovoltaic power potential (PVOUT)**

Source: Data obtained from the “Global Solar Atlas 2.0, a free, web-based application is developed and operated by the company Solargis s.r.o. on behalf of the World Bank Group, utilizing Solargis data, with funding provided by the Energy Sector Management Assistance Program (ESMAP). For additional information: <https://globalsolaratlas.info>

## SOLAR POWER POTENTIAL IN KOSOVO

Based on data from the Global Solar Atlas, the specific yield potential or PVOUT for Kosovo is around 3.7 kWh/kWp per day or 1,350 kWh/kWp in a year. The PV power output (PVOUT) represents the amount of power generated per unit of the installed PV capacity over the long-term, and it is measured in kilowatthours per installed kilowatt-peak of the system capacity (kWh/kWp).

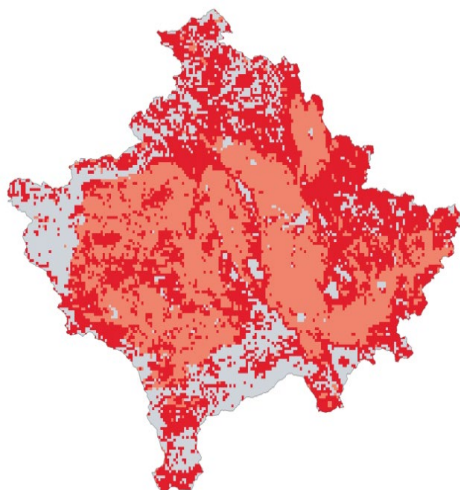
The practical PV potential, is the power output achievable by a typical configuration of the utility scale PV system, taking into account the theoretical potential, the air temperature affecting the system performance, the system configuration, shading and soiling, and topographic and land-use constraints.



**Figure 2 PV power output (PVOUT) in Kosovo.**

Source: [globalsolaratlas.info/global-pv-potential-study](https://globalsolaratlas.info/global-pv-potential-study).

On a PVOUT scale from 1 to 7 (kWh/kWp), Kosovo with its specific yield potential of around 3.7 kWh/kWp has unique opportunity to utilize solar photovoltaics to provide affordable, reliable, and sustainable electricity supply as part of the energy mix.



kWh/kWp	Evaluated Area		
	43%	79%	100%
	Level 2	Level I	Level 0
over 3.8	3.90%	7.40%	8.30%
3.8 - 3.6	30.50%	61.90%	70.90%
3.6 - 3.4	8.30%	9.40%	17.60%
below 3.4	0.30%	0.30%	3.20%

Source: [globalsolaratlas.info/global-pv-potential-study/](https://globalsolaratlas.info/global-pv-potential-study/)

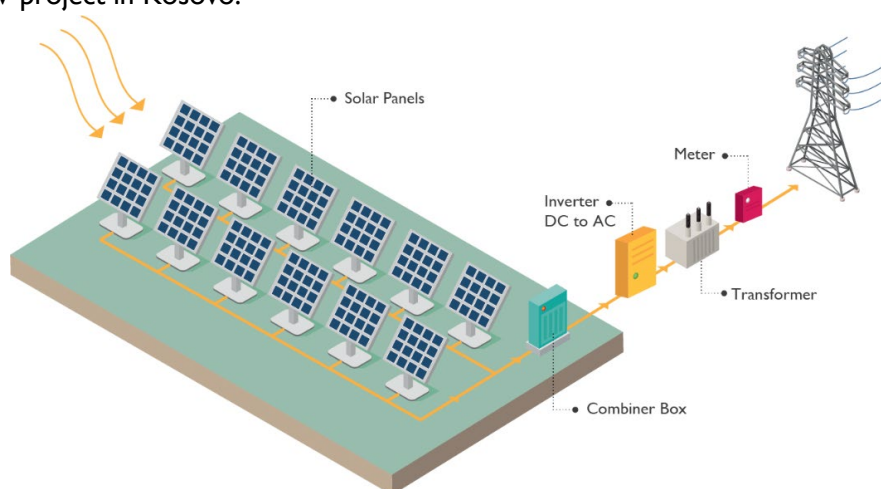
**Figure 3 Distribution of photovoltaic power output.**

## TYPES OF PV GENERATORS

The following section describes typical solar PV project types as defined in the legal and regulatory framework of Kosovo. These definitions are then used throughout the report.

### LARGE SOLAR PV GENERATORS

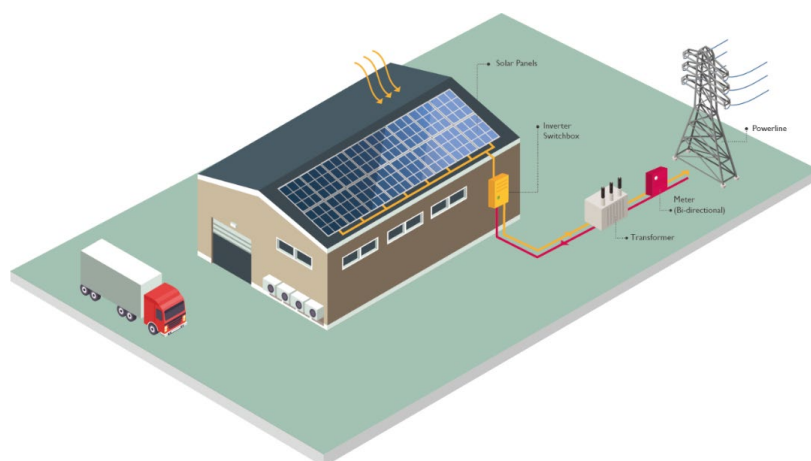
Large solar photovoltaic (PV) generators in Kosovo are considered those with installed capacity over 100 kW. If the generator is part of the Support Scheme, i.e., project benefiting from the 12-year guaranteed Power Purchase Agreement with Feed-in Tariff, priority dispatch and liable for only 25% of their disbalance, then the maximum allowed size of single project is limited to 3 MW. Large solar PV projects may be connected to the distribution or transmission network. Figure 4 illustrates a typical large solar PV project in Kosovo.



**Figure 4 Large solar PV generator**

### PROSUMERS (SELF-CONSUMPTION GENERATORS)

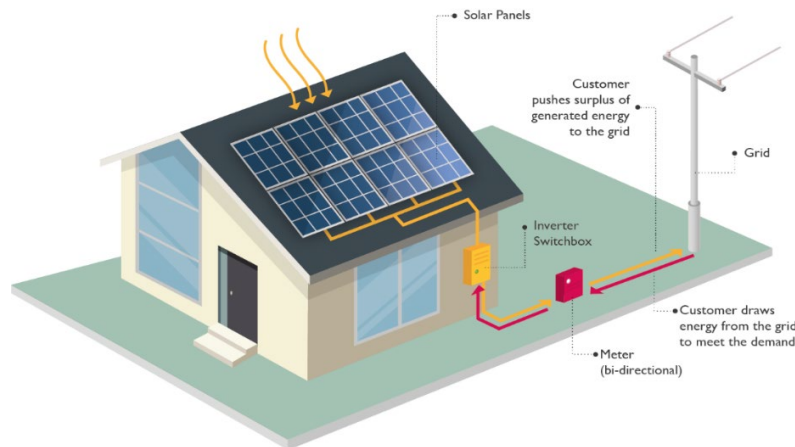
Any customer (household or business) connected to the low-voltage distribution network is allowed to install a small (<100kW) solar PV system to meet part of their own demand as a cost saving measure or to reduce their CO2 footprint. If the customer is authorized by Energy Regulatory Office to construct such installation and meets the technical and legal conditions, then the customer is admitted to the Support Scheme and obtains status of a “Prosumer”. Figure 5. Illustrates a business with status of a Prosumer.



**Figure 5 Business with status of a Prosumer and solar PV installation**

To improve bankability of the small PV installations, Prosumers are allowed to inject excess electricity to the grid that is metered by a bi-directional meter and credited to future energy consumption within the same billing period (calendar year). This is known as net-metering or Prosumer support scheme.

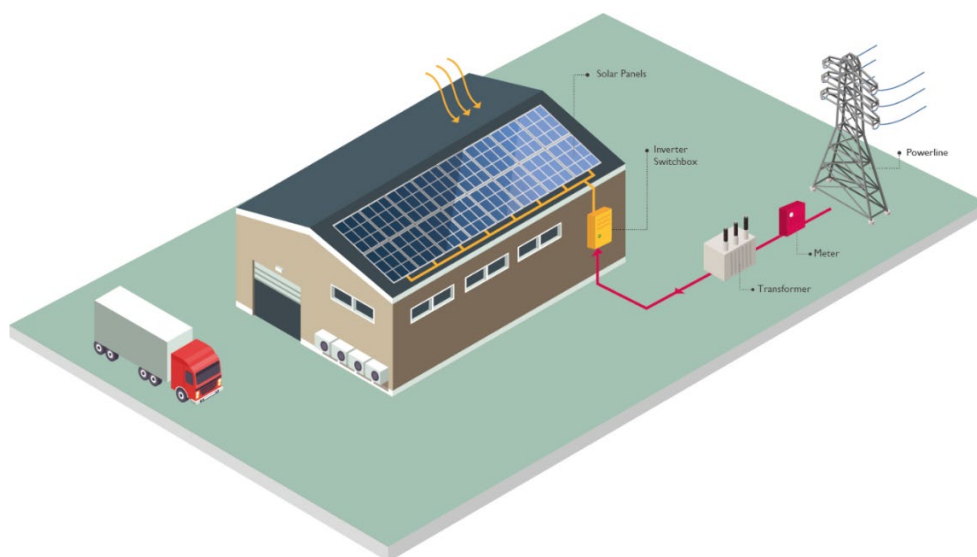
When the PV system does not generate enough to cover their electricity demand, a Prosumer receives electricity from the grid, similar to regular customers. Figure 6 illustrates a typical household Prosumer.



**Figure 6 Household with a status of a Prosumer and solar PV installation**

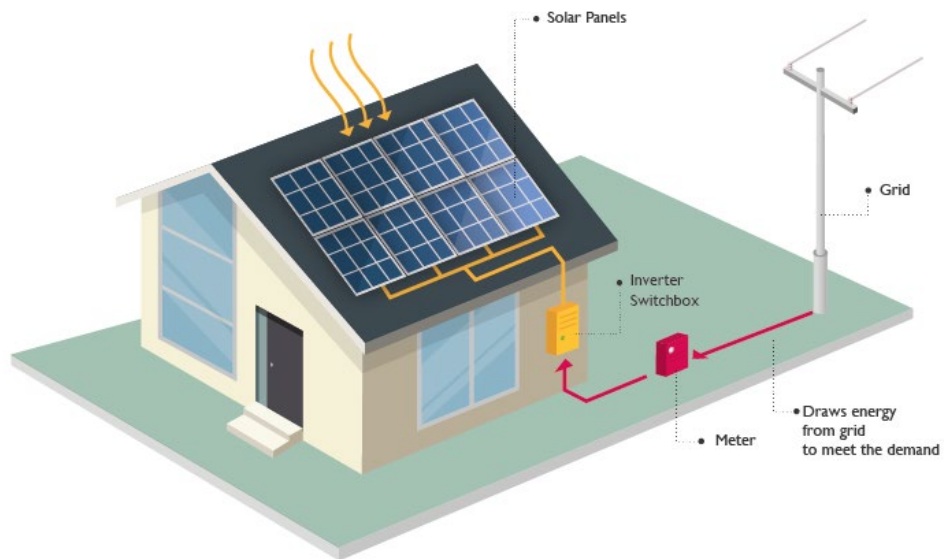
## BEHIND-THE-METER PV INSTALLATIONS

Any consumer of electricity not connected or connected to the electricity grid can install any size solar PV installation to meet their entire or part of their electricity demand as their own internal electricity supply option, a cost saving measure by offsetting their energy consumption from the grid, or to reduce their CO<sub>2</sub> footprint. The entire generated electricity from such solar PV system is consumed internally and no electricity is injected to the grid. Hence, this type of system is referred throughout this report as Behind-the-meter system or as industry refers to “zero export” installation. Figure 7 illustrates a typical business with Behind-the meter solar PV installation.



**Figure 7 Business customer with Behind-the-meter solar PV installation**

Figure 8 below illustrates a typical Behind-the-meter household installation.

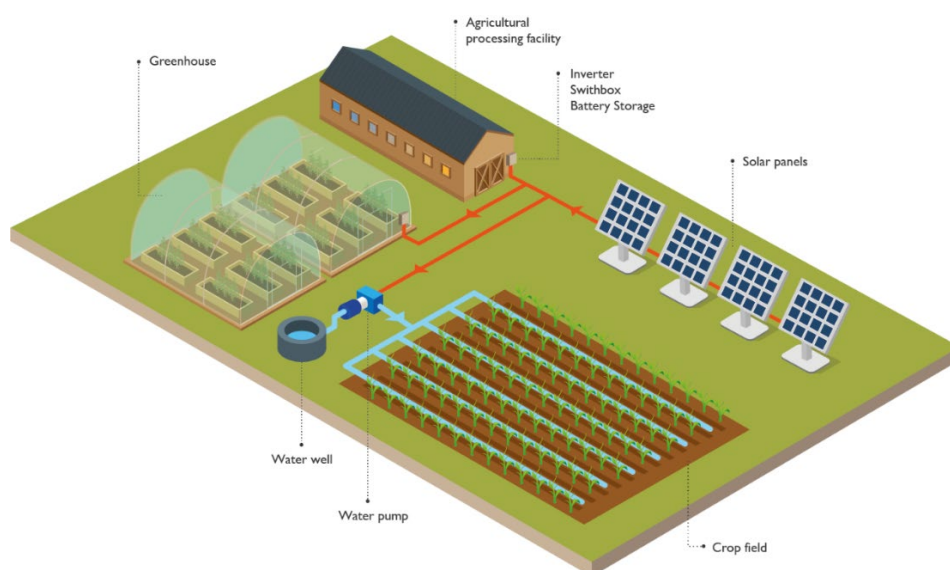


**Figure 8 Behind-the-meter generator**

In case such consumer is also a customer of the electricity supply company they continue to receive regular electricity supply from the grid when their solar PV system does not meet the demand.

### OFF-GRID SOLAR PV

There are more than a thousand solar PV installations throughout Kosovo that are completely off-grid (meaning they are not connected to the grid). These types of solar PV installations which are found mainly in agricultural sector are used for water pumping or providing electricity supply to green-houses or processing facilities in the remote areas. These projects are supported through agricultural grants. Figure 9 below illustrates a typical off-grid solar PV generator in agriculture.



**Figure 9 Off-grid solar PV generator in agriculture**

## **LEGAL, POLICY AND REGULATORY FRAMEWORK FOR PV PROJECTS IN KOSOVO**

The following chapter describes Kosovo's international obligations, current policy and strategy, legal and regulatory framework for renewable energy sources (RES) with particular focus on solar photovoltaic (PV) projects development.

The chapter is divided into five parts:

1. Introduces Kosovo's international obligations deriving from the Energy Community Treaty, applicable EU laws and regulations, and mandatory RES targets.
2. Focuses on Kosovo RES policy, Kosovo Energy Strategy, and National Renewable Energy Action Plan (NREAP).
3. Covers the applicable legal & regulatory framework for RES in Kosovo.
4. Highlights fiscal policy as applicable to the RES sector.
5. Provides an overview of Kosovo's stakeholders governing the energy sector.

### **INTERNATIONAL ENERGY LEGAL FRAMEWORK RELEVANT TO KOSOVO**

#### **ENERGY COMMUNITY TREATY**

The Republic of Kosovo is a party to the Energy Community Treaty (EnC Treaty), signed in October 2005, which brings together the European Union and its neighbors to create an integrated pan-European energy market. The primary goal of the Energy Community (EnC) is to create a stable and single regulatory framework and market space that ensures reliable energy supply and attracts investments, improve environmental conditions and energy efficiency, while at the same time enhancing the utilization of renewable energy sources.

Pursuant to Article 20 of the EnC Treaty, Kosovo and other Contracting Parties (CP) have committed to transpose and implement relevant EU directives and regulations ("Acquis Communautaire") pertaining to the energy sector.

#### **RENEWABLE ENERGY SOURCES (RES) DIRECTIVE 2009/28/EC**

RES Directive 2009/28/EC is the most recent directive on renewable energy, based on Decision 2012/04/MC-EnC and Decision 2018/02/MC-EnC amending Decision 2012/04/MC-EnC, is also obligatory for the EnC CPs. The directive sets a mandatory 2020 RES target for CPs of 20% of gross final energy consumption. These baseline targets are a baseline to ensure CPs encourage continuous development of RES, thereby providing more certainty for prospective investors. The targets for each CP were further adjusted taking into account individual CP RES potential, existing level of RES penetration, as well as other factors. Subsequently, for Kosovo, the 2020 RES target was increased to 25% of total energy consumption.

RES Directive 2009/28/EC further stipulates that only electricity produced by RES installations that become operational after the entry into force of the directive, or the increased capacity of an installation that was refurbished after that date, should be counted toward meeting the target.

To help ensure effective implementation of RES Directive 2009/28/EC, each CP is required to establish a national renewable energy action plan (NREAP) including information on targets by each sector. When evaluating its expected gross final energy consumption in its national renewable energy action



plan, the contribution which energy efficiency and energy saving measures can make to achieve its national targets are considered as well. Therefore, CPs should take into account the optimal combination of energy efficiency technologies with RES energy.

One important means to achieve the aim of the RES Directive is to guarantee the proper functioning of national support schemes, in order to maintain investor confidence and allow CP to design effective national measures to comply with mandatory targets. The directive defines a support scheme as any instrument, scheme, or mechanism applied by a CP or a group of CPs, that promotes the use of energy from RES “by reducing the cost of that energy, increasing the price at which it can be sold, or increasing, by means of a renewable energy obligation or otherwise, the volume of such energy purchased.” This includes, but is not restricted to, investment aid, tax exemptions or reductions, tax refunds, renewable energy obligation support schemes including those using green certificates, and direct price support schemes including renewable energy feed-in tariffs (FiTs) and premium payments.

Article 3 of RES Directive 2009/28/EC sets forth that, in order to reach national RES targets, the CPs may apply either domestic support schemes or regional support schemes with other CPs. In the case of solar energy, CPs must ensure certified equipment and systems based on EU standards, including eco-labels, energy labels, and other technical reference systems.

According to RES Directive 2009/28/EC, CPs must report to EC whether they intend to:

- Establish a single administrative body responsible for processing authorization, certification and licensing applications for renewable energy installations and providing assistance to applicants;
- Provide for automatic approval of planning and permit applications for renewable energy installations where the authorizing body has not responded within the set time limits;
- Indicate geographical locations suitable for exploitation of energy from renewable sources in land-use planning and for the establishment of district heating and cooling.

RES Directive 2009/28/EC also requires CPs take appropriate measures in order to allow a higher penetration of electricity from RES by taking into account the specificities of variable resources and those that are not yet storable and by allowing priority connection (or reserved connection capacity) for new RES installations. RES Directive 2009/28/EC further stipulates that “administrative approval procedures should be streamlined with transparent timetables for installations using energy from renewable sources”.

In going forward, the European Commission (EC) announced that a new timeframe for setting 2030 RES targets will be adopted by mid-2021 after a comprehensive study on RES targets in each CP is developed to serve as a basis for negotiations with CPs. Based on the Annual Implementation Report 2018/2019 by the Energy Community Secretariat (ECS) published on November 1, 2019, Kosovo achieved a 22.9% share of RES in gross final energy consumption in 2017, in line with its 22.9% median trajectory for 2017-2018. This was due to the revision of biomass consumption for heating by household customers rather than investment in renewable energy.

## **CLEAN ENERGY FOR ALL EUROPEANS**

In 2019 the EU completed a comprehensive update of its energy policy framework to facilitate the transition away from fossil fuels towards cleaner energy and to deliver on the EU's Paris Agreement commitments for reducing greenhouse gas emissions. The EU is leading the clean energy transition: striving for a more secure, competitive, and sustainable energy system which will address the

existential challenge of our time – climate change. By setting ambitious energy and climate targets for 2030, the EU is giving a clear sense of direction. In addition to these targets, it provides a stable legal framework to foster the necessary investment. With its 2050 long-term climate neutrality strategy, the EU is also looking further ahead than 2030, and setting the foundations for what a cleaner planet will look like by the middle of the century and beyond.

Following the political agreement by the Council and the European Parliament (between May 2018 and May 2019) and the entry into force of the different EU rules, EU countries have 1-2 years to transpose the new directives into national law. The new legislative acts are not yet applicable for EnC CPs, but the EC is in the process of integrating the directive into the EC Acquis Communautaire at which point Kosovo would be required to transpose them into national legislation.

The new rules will bring considerable benefits from a consumer perspective, from an environmental perspective, and from an economic perspective.

The Clean energy for all Europeans package consists of eight legislative acts:

1. Energy Performance of Buildings Directive 2018/844;
2. The recast Renewable Energy Directive (EU) 2018/2001;
3. The revised Energy Efficiency Directive (EU) 2018/2002;
4. Governance of the Energy Union and Climate Action (EU) Regulation 2018/1999;
5. Regulation on risk-preparedness in the electricity sector (EU) 2019/941;
6. Regulation establishing a European Union Agency for the Cooperation of Energy Regulators (EU) 2019/942;
7. Regulation on the internal market for electricity (EU) 2019/943;
8. Directive on common rules for the internal market for electricity (EU) 2019/944.

## **EU DIRECTIVE 2018/2001 ON THE PROMOTION OF THE USE OF ENERGY FROM RES**

EU Directive 2018/2001 revised RES Directive 2009/28/EC and was adopted on December 11, 2018. The directive establishes a binding EU target of at least 32% of energy sector coming from RES by 2030 with a review to consider increasing this figure to occur in 2023.

EU Directive 2018/2001 is not yet applicable for CPs, but the EC is in the process of integrating the directive into the EC Acquis Communautaire at which point Kosovo would transpose this more ambitious RES target into national legislation. Given that Kosovo appears on track towards its mandatory 25% RES target by 2020, it appears likely that Kosovo's 2030 target will be in line with the binding target established in the directive.

EU Directive 2018/2001 also stipulates that any support scheme chosen by CPs must be granted in an open, transparent, competitive, and cost-effective manner, in the form of a market premium, which could be, inter alia, sliding or fixed. Small-scale installations and demonstration projects may be exempted from these requirements.

The directive also establishes that the permit-granting process shall not exceed two years for power plants, including all relevant procedures of competent authorities. Where duly justified on the grounds of extraordinary circumstances, that two-year period may be extended by up to one year. The permit-granting process shall not exceed one year for installations with an electrical capacity of less than 150 kW and may be extended only based on extraordinary circumstances, by up to one year.

## **GUIDELINES ON STATE AID FOR ENVIRONMENTAL PROTECTION AND ENERGY**

The EC Guidelines on State Aid for environmental protection and energy 2014-2020, recently extended to apply to 2021, stipulate a transition toward more market-oriented support mechanisms such as tenders or auctions. The aim is to ensure a cost-effective market-based delivery of RES. The guidelines require that subsidies and exemptions should be phased out and that beneficiaries shall sell their electricity directly to the market. The guidelines set forth that from January, 1 2017, state aid shall be granted through a competitive bidding process for all capacity higher than 1 MW.

## **POLICY GUIDELINES BY THE ENERGY COMMUNITY SECRETARIAT ON THE INTEGRATION OF RENEWABLES SELF-CONSUMERS**

The Policy Guidelines on the Grid Integration of Prosumers published by the Energy Community Secretariat on 5 February 2018 provided recommendations on the regulatory and technical aspects of self-consumption schemes in order to improve their operation in the Energy Community Contracting Parties. A particular emphasis is given to small renewable installations connected to the distribution network owned by final customers. The Policy Guidelines are based on European best practice, given the lack of a legal basis in the European Union at the time, as well as on the findings and recommendations of a study on distributed generation for self-consumption.

In the meantime, a legally binding framework for self-consumption was adopted in the European Union (EU) as part of the so-called Clean Energy for all Europeans Package (CEP). The CEP aims to facilitate decarbonisation of the energy sector and implement greenhouse gas emissions reduction commitments in line with the Paris Agreement. It sets 2030 targets for greenhouse gas emissions, renewable energy and energy efficiency, and establishes the necessary legal framework to underpin their implementation.

The CEP sets the legal ground for final customers to, individually or as a group, generate, consume, store, and sell self-generated electricity. The new Renewable Directive obliges EU Member States to put in place an enabling framework to promote and facilitate the development of renewable self-consumption based on an assessment of the existing unjustified barriers to, and of the potential of renewable self-consumption. In their National Energy and Climate Plans (NECPs) and progress reports, EU Member States shall include a summary of the policies and measures under the enabling framework and an assessment of their implementation.

While the CEP, together with an obligation to promote renewable self-consumption, is not yet a legal obligation in the Energy Community, its relevance is clear. Self-consumption can offer economic, social, and environmental benefits and provide access to affordable and sustainable energy. With a view to bridge the identified gaps and ensure that the development of the necessary policies and measures to promote and facilitate self-consumption in the Energy Community are in line with the framework defined by the CEP, the Policy Guidelines by the Energy Community Secretariat on the Integration of Renewables Self-consumers, updates the Secretariat's 2018 Policy Guidelines on the Grid Integration of Prosumers. The changes harmonise the Policy Guidelines with CEP terminology and the new provisions governing self-consumption.

The overall purpose of the Policy Guidelines is to provide recommendations to policymakers in the Contracting Parties on the development of legal frameworks conducive to self-consumption and empower consumers to actively participate in the self-consumption of renewable energy.

In 2018, the Contracting Parties adopted the General Policy Guidelines on 2030 Targets, whereby they also committed to adopting the new Energy Efficiency Directive, the new Renewable Energy Directive and the Governance Regulation introduced by the CEP. The European Commission is expected to propose the adoption of the relevant legislative package for the Energy Community alongside the 2030 targets in the first half of 2021.

The Governance Regulation defines a framework for reporting on the status of implementation of NECPs by means of integrated national energy and climate progress reports. According to Article 20 of the Governance Regulation, integrated reporting on renewable energy should include information on the implementation of the trajectories and objectives, as well as on the implementation of the defined policies and measures, including those related to renewable self-consumption.

The process of developing NECPs in the Contracting Parties has already started following the Secretariat's non-binding Policy Guidelines, which set the timeline for their finalisation before 2021. In developing NECPs and preparing for the forthcoming progress reporting on their implementation, the Contracting Parties should recognise the importance of renewable self-consumption in the decarbonisation process.

To properly address self-consumption in NECPs, the Contracting Parties should consider the recommendations presented in Table I.

**Table I Recommendation Sets of Policy Guidelines on the Integration of Renewables Self-Consumers**

<b>RECOMMENDATIONS SET #1 POLICY FRAMEWORK</b>	<b>RECOMMENDATIONS SET #2 LEGAL AND REGULATORY FRAMEWORK</b>
<ul style="list-style-type: none"> <li>• Current status and potential for self-consumption deployment</li> <li>• Self-consumption targets</li> <li>• Barriers to self-consumption deployment</li> <li>• Strategy for the development of self-consumption</li> <li>• Progress monitoring and reporting</li> </ul>	<ul style="list-style-type: none"> <li>• Renewable self-consumer activities, rights and obligations</li> <li>• Non-discrimination</li> <li>• Criteria and organisation of self-consumers</li> <li>• Administrative procedures</li> <li>• Support schemes</li> <li>• Cost reflectivity</li> <li>• Charges and fees</li> <li>• Access to information on self-consumption</li> <li>• Subsequent legislative changes</li> <li>• VAT legislation</li> </ul>
<b>RECOMMENDATIONS SET #3 TECHNOLOGIES AND TECHNICAL REQUIREMENTS</b>	<b>RECOMMENDATIONS SET #4 SELF-CONSUMPTION AND ACCESS TO THE MARKET</b>
<ul style="list-style-type: none"> <li>• Renewable technology</li> <li>• Energy storage technology</li> <li>• Voltage level</li> <li>• Network planning</li> <li>• Installed capacity criteria</li> <li>• Capacity limitation for households and small commercial consumers self-consumption installations</li> <li>• Capacity limitation for industrial and large commercial consumers self-consumption installations</li> <li>• Capacity limitations for energy storages combined with renewable self-generation</li> <li>• Smart metering systems</li> <li>• Customer right to smart meters</li> <li>• Connection procedure and DSO authorization</li> </ul>	<ul style="list-style-type: none"> <li>• Remuneration schemes</li> <li>• Net metering scheme</li> <li>• Net billing scheme</li> <li>• Accounting and compensation in the case of netting schemes</li> <li>• Dynamic pricing schemes and demand response</li> <li>• Jointly acting renewable self-consumers</li> <li>• Peer-to-peer trading</li> <li>• Energy services business model</li> <li>• Supplier switching</li> <li>• Balance responsibility</li> <li>• Access to metering data</li> </ul>
<b>RECOMMENDATIONS SET #5 SELF-CONSUMPTION AND ACCESS TO THE NETWORK</b>	<b>RECOMMENDATIONS SET #6 VAT AND OTHER TAXES AND LEVIES</b>
<ul style="list-style-type: none"> <li>• General</li> <li>• Network tariffs in the case of the net-metering scheme</li> <li>• Network tariffs for self-consumers</li> <li>• Grid tariffs for self-consumers with storage systems</li> <li>• Self-consumption impact on the network and network charges</li> </ul>	<ul style="list-style-type: none"> <li>• General</li> <li>• Exemptions</li> <li>• VAT</li> </ul>

## KOSOVO ENERGY STRATEGY AND RES POLICY

### KOSOVO ENERGY STRATEGY

In January 2018, the Assembly of the Republic of Kosovo adopted the Energy Strategy of the Republic of Kosovo 2017-2026. The Energy Strategy was developed in line with EC Treaty, EU Rules and international standards on sustainable development, environmental and social protection, diversification of energy sources, and encouraging RES utilization.

The strategy is based on following five objectives:

1. Security of sustainable and quality supply of electricity with the necessary capacities for a stable electricity system;
2. Integration in the Regional Energy Market;
3. Enhancing existing capacities of thermal systems and building new capacities;
4. Development of natural gas infrastructure;
5. Fulfilment of objectives and obligations in the field of energy efficiency, renewable energy sources and environmental protection.

The Energy Strategy identified significant challenges that must be addressed in relation to:

- Outdated and insufficient generation capacities to address the demand for electricity consumption (especially in the winter) and for power system reserve and balancing;
- High environmental pollution due to power generation from obsolete thermal power plants;
- Insufficient utilization of RES generation; and
- High technical and non-technical losses in the electricity distribution network.

The final aim of the current version of the Energy Strategy is to enhance a cleaner energy, targeting around 400 MW of renewables into the system by 2026, in line with EU targets.

The Energy Strategy also states that the use of RES in energy generation is a long-term target for the implementation of three energy policy milestones of the country:

- 1) Support of overall economic development;
- 2) Increased security of energy supply; and
- 3) Environmental protection.

The Strategy maintains that “in view of these milestones, it is necessary to apply fiscal and financial incentives for all types of RES including the implementation of the support scheme based on the mechanism of the certificates of origin.”

### ENERGY STRATEGY IMPLEMENTATION PLAN

Energy Strategy Implementation Plan 2018-2020, adopted in July 2018, included a list of 27 specific objectives and 97 activities that were aimed to be undertaken for the development of the energy sector by 2020.

The plan listed a wide range of issues negatively affecting power sector performance, including

- Insufficiency of generation capacity;
- Lack of secondary and tertiary power reserves in the system due to the lack of flexible generation;

- Limited capacity of thermal energy systems;
- Lack of natural gas infrastructure;
- Considerable technical and commercial losses in the distribution network;
- KOSTT failure to manage cross-boundary flows due to obstacles from the TSO of Serbia;
- Inadequate use of energy saving potential;
- Inadequate use of RES potential; and
- Lack of an effective competitive market in the electricity sector.

In addition to other measures, and to enhance investments, the implementation plan foresees capacity building for RES installers of energy equipment (including Photovoltaic Panels) and training on certification of RES energy equipment installers. The other measures introduced under the strategy implementation plan are: (i) Implementation of support schemes – the Feed-in Premium, and (ii) Propose steps to simplify authorization procedures for RES projects.

### **NATIONAL RES ACTION PLAN (NREAP) 2013**

With the view of supporting and promoting the use of RES, and in line with the Energy Strategy and legal obligations deriving from the EnC Treaty, the Ministry of Economic Development (MED) drafted a ten-year (2011-2020) national renewable energy action plan (NREAP) adopted in 2013.

The NREAP has determined the RES goals for period covering 2011-2020 as outlined in the Table 2 below.

**Table 2 National overall targets for the share of energy from RES by 2020**

DESCRIPTION	MANDATORY	VOLUNTARY
Target of energy from renewable sources in gross final consumption of energy (%)	25%	29.47%
Expected total adjusted energy consumption (ktoe)	1729.82	1729.82
Expected amount of energy from renewable sources corresponding to the 2020 target (ktoe)	432.46	509.70

Source: NREAP, 2013

Three different sub-sectorial targets were introduced to facilitate the achievement of the RES energy target for 2020:

- 25.64% penetration of RES in the gross final electricity consumption, which must be achieved by the installation of small hydropower plants (240 MW), Zhuri hydropower plant (305 MW), wind plants (150 MW), biomass plants (14 MW) and photovoltaic plants (10 MW).
- 10% penetration of RES of total energy consumption in transport, which must be achieved by the deployment of biofuels.
- 45.65% penetration of RES of total energy consumption for heating and cooling, which must be achieved by the promotion of solar energy (70 MW thermal (MWth)), geothermal heat pumps (10 MWth) and biomass in the form of traditional logwood.

According to the presented results in NREAP (May 2020, Update for 2018-2020) the fulfillment of the mandatory 25% total RES target is not feasible with the policies elaborated in the 2013 version of the NREAP and additional measures taken up to 2018. Significant deviations are observed for RES targets

in comparison with the initial plan, significantly hindering the achievement of the voluntary RES target considering the limited time available for reaching the RES objectives until the end of 2020.

Section 4.1 of the NREAP lists measures for increasing solar energy utilization and lists activities that shall be undertaken to achieve specific measures. Measures and activities related to solar PV are stated in NREAP as listed Table 3 below.

**Table 3 Measures for increasing PV utilization in accordance with NREAP 2013**

MEASURE	ACTIVITIES	ANTICIPATED TIMELINE
Identify Solar potential	Develop Study on solar energy use	2014
Form clusters for increased use of solar energy	Establish clusters dealing with all aspects of deployment of solar energy projects	2017
Develop auctioning rules (follow up on FiT scheme)	Change in legislation: amendment of law, adoption of Rules	2019

## ADMINISTRATIVE INSTRUCTION ON USE AND SUPPORT OF ENERGY GENERATION FROM RENEWABLE SOURCES

The purpose of Administrative Instruction No. 02/2013 was to identify types of renewable energy sources to be used for the purposes of generating electricity and thermal energy, groups, conditions of use, technical standards, support schemes, statistical transfers, joint projects, and other relevant issues for the use of renewable energy sources.

At that time, there were three categories of plants used for electricity generation:

- Group 1 – up to 1MW: photovoltaics panels in the buildings up to 10kW connected to the grid; photovoltaics panels in the buildings over 10kW connected to the grid and; solar plants with other installed capacities.
- Group 2 – included all the photovoltaics systems connect to the grid with over 1MW installed capacity.
- Group 3 – included all photovoltaics systems not connected to the grid, without limitation to the installed capacity.

With entry into force of new AI No. 06/2017, the AI No. 02/2013 was abolished.

## ADMINISTRATIVE INSTRUCTION ON ESTABLISHMENT OF RES MANDATORY TARGETS

The objective of Administrative Instruction is to adopt long-term and annual targets for renewable energy sources. The administrative instructions comply in part with the provisions of European Parliament and Council Directive 2009/28/EC of April 23, 2009 on promoting the use of energy from renewable sources.

- The AI No.01/2013 has set 2020 target for photovoltaics to **10 MW** installed capacity.
- The AI No.05/2017 has set 2020 target for photovoltaics to **30 MW** installed capacity (increase by additional 20 MW from previous target established under AI No.02/2013).



The AI No. 06/2017 adopted in August 2017 on utilization and support of energy generation from renewable sources divides electricity production plants into following categories:

**Table 4 categories of power generation facilities**

CATEGORY	DESCRIPTION	INSTALLED CAPACITY	COMMENT
1	Plants connected to electric grid	Up to 100 kW	This category includes solar photovoltaic plants
2	Plants connected to electric grid	Over 100 kW	This category includes solar plants (photovoltaic systems) with installed capacity of up to 3MW
3	Plants for self-consumption	n/a	This category includes solar photovoltaic plants

Article 4.2.1 and Article 7 of the AI No. 06/2017 states that projects of up to 100 kW shall be subject to simple authorization procedure adopted by Energy Regulatory Office (ERO) and other relevant institutions dealing with permitting issues. In April 2017, ERO adopted the “Rule on Authorization of New Generation Capacities for RES Generators” that enhanced a simplified procedure for RES projects.

According to Article 9 of the AI No. 06/2019, with the aim of achieving renewable energy targets and up to the moment such targets are achieved, generators of electricity from renewable energy sources shall be accepted to the support schemes and will have the right to enter into power purchase agreements with the Market Operator with compensation via feed-in tariffs or feed-in premiums. Moreover, paragraph 3 of Article 9 stipulates that installations over 100kW can be supported via feed-in premium which should be allocated through competitive processes.

## KOSOVO LAWS APPLICABLE FOR PV PROJECTS

### LAW ON ENERGY NO. 05/L-081

The Law on Energy No. 05/L-081 adopted July 13, 2016 establishes the general principles and rules to govern activities in the energy sector. The law establishes the conditions for a functioning open energy market and the increased supply of power from RES and cogeneration. The law was developed to comply with Directive 2009/72/EC on the common rules for the internal market in electricity, Regulation No.714/2009/EC on conditions for access to the network for cross-border exchanges in electricity, and RES Directive 2009/28/EC concerning promotion of use of energy from renewable energy sources.

The law defines RES as non-fossil energy: wind, solar, geothermal, waves, hydro, biomass, waste landfill gas, wastewater treatment gas, and biogas. Renewable energy targets are specified as a “policy objectives of reaching a share of energy produced from energy sources in gross final energy consumption until a deadline specified in this Law.”

The law stipulates that the TSO or DSO shall give priority to electricity generated from RES in accordance with the Grid Code, Connection methodology, and other rules and codes. The TSO or DSO shall provide any new RES producer with a comprehensive and detailed estimate of the costs associated with the connection for which estimate the system operator may levy a charge that reflects its reasonable costs. ERO is obliged to ensure that fees for connection and use of the transmission and distribution systems do not discriminate against the RES operators.

The law calls for government to establish annual and long-term RES targets for the consumption of electricity. Long-term RES targets shall be developed for a ten (10) year period, according to the methodology determined by sub-legal acts, approved by the MED.

The law also mandates that government adopt the NREAP, in line with EnC requirements. The Kosovo NREAP called for Kosovo to reach 25% share of energy from RES in gross final energy consumption in 2020. MED is tasked for drafting and publishing an annual status updates on the realization of long-term RES targets as part of NREAP reporting requirements.

For smaller projects and for decentralized projects for producing energy from RES, ERO shall establish simplified and less burdensome authorization procedures, including simple notification if allowed by the applicable legislation.

#### **LAW ON ELECTRICITY 05/L-084**

The Law on Electricity 05/L-085 was adopted July 13, 2016. The law establishes conditions for generation, distribution, and trade of electricity, as well as the organization of the Kosovo electricity market. The main purposes of the law are to achieve a competitive and sustainable electricity market; guarantee conditions for supply of electricity; and to ensure that all customers have the right to be supplied electricity at a reasonable price.

The law also deals with Certificates of Origin for RE and cogeneration (Article 8). Based on the law, the Certificate of Origin is an electronic document issued by ERO which provides proof to the final customer that a given quantity of energy was produced from RES. Power certified to originate from RES is entitled to priority dispatch under the terms stated in the Grid Code and Market Rules. A Certificate of Origin equates to one MWh of power produced and not more than one certificate shall be issued for each produced unit.

#### **LAW ON THE ENERGY REGULATOR NO. 05/L-084**

The Law on the Energy Regulator, adopted July 13, 2016, defines the powers, duties, and functions of the ERO. These include conditions for issuing licenses; procedures for granting authorization to construct new generating capacity; the creation of competitive energy markets; and criteria for regulating tariffs and the conditions of energy supply. The law was written to comply with Directive 2009/72/EC on common rules for the internal market in electricity, Regulation 714/2009/EC on conditions for access to the network for cross-border exchanges in electricity, and RES Directive 2009/28/EC concerning promotion of use of energy from renewable energy sources.

The law identifies the two ways to build new RES generation capacity in Kosovo:

- I. through the Authorization Process (Article 43 of the law), or

2. through the Tendering Process (Article 44 of the law).

The **Authorization Process** is administrated by ERO in accordance with the Rule on Authorization of New Generation Capacity, adopted by ERO on April 27, 2017.

The **Tendering Process** is performed by the Government of Kosovo either when ERO issues a written decision that the authorization procedure has not resulted successfully in the building of sufficient electricity generation capacity to ensure security of supply or to meet environmental targets; or if RES objectives are not being met. The tendering process shall be conducted by the Public Private Partnerships Inter-Ministerial Steering Committee, as per the Law on Public Private Partnership. The law does not recognize auction as a third mean that is particularly important for construction of large RES generation facilities

## **LAW ON STRATEGIC INVESTMENTS NO. 05/L-079**

The Law on Strategic Investments, adopted February 8, 2017, establishes administrative procedures and criteria for implementation of strategic projects in Kosovo, including energy projects. The minimum investment needed to gain the status of strategic investment for energy project is 30 million Euros. Any investor who wishes to propose a strategic investment in energy sector must submit a written request to the Investments and Enterprise Support Agency (KIESA) in accordance with applicable secondary legislation. The status of Strategic Investment does not deliberate the investor for obtaining all necessary authorizations and licenses from ERO. Furthermore, strategic investments cannot benefit from both, the RES support scheme, and any GoK co-investment such as public land or cost sharing for energy infrastructure.

The investment may also be initiated as an unsolicited proposal or through a Government of Kosovo initiative. The Government of Kosovo may invite investors to apply to any strategic project when the Government evaluates that public interest may be achieved through tender procedures foreseen in the Law on Public and Private Partnerships and the Law on Public Procurement. The invitation to participate in the selection procedure shall be published in accordance with the relevant provisions of Law on Public Procurement that enhances transparency and non-discriminatory approach.

## **LAW ON PUBLIC PRIVATE PARTNERSHIP**

Law No. 04/L-045 on Public Private Partnership (“Law on PPP”), adopted on October 21, 2011 is applicable to energy infrastructure, excluding the construction of new energy generation capacities, as set forth in Article 2, paragraph 1.2 of the law. The construction of new generators will be “governed by Law on the Energy Regulator, unless otherwise determined in such law”.

The Law on Energy Regulator no. 05/L-084 in Article 44 provides clear reference to the Law on PPP by stating that a tendering procedure for new generators shall be designed according to objective, transparent and non-discriminatory criteria in full accordance with the applicable provisions of the Law on Public-Private Partnerships.

The Law on PPP applies for the provision of Public Services and/or Public Infrastructure and defines PPP as “any contractual or institutional cooperation between one or more Public Authorities and one or more Private Partners”.

Selection of the private partner for PPP shall follow the procurement procedures established in the Law on Public Procurement and be implemented through transparent open competition procedure.

The Law on Public Procurement follows the same principle as the Law on PPP, that are based on transparent competitive process that is non-discriminatory and enhances the best international procurement practices.

## **ENERGY REGULATORY RULES**

The regulatory framework for development of RES projects is defined in following ERO's rules:

- Rule on Authorization Procedure for Construction of New generating Capacities from Renewable Energy Sources (27 April 2017);
- Rule on Support Scheme, Rule No 10/2017 (27 April 2017); and
- Rule for the Establishment of a System of Certificates of Origin for Electricity Produced from RES (29 December 2010).

Any investor who intends to invest in RES projects in Kosovo can sell their energy under the following frameworks:

- Support Scheme (FiT, Net-metering);
- Regulated Framework; and
- Market based, unregulated framework

## **RULE ON AUTHORIZATION PROCEDURE FOR CONSTRUCTION OF NEW GENERATION CAPACITIES FROM RES**

Rule on Authorization Procedure for construction of new Generation Capacities from Renewable Energy Sources, initially adopted by ERO on November 11, 2014 and later replaced by Rule adopted on April 27, 2017 established the procedure for construction of new generation capacity from RES, including solar photovoltaics. In accordance with the Rule RES are defined as:

- Large-scale RES generation capacity - any new grid-connected project over 100 kW; and
- Small-scale generation – any new grid-connected project with capacity less than 100 kW.

The legal requirements according to the Rule on Authorization are divided in general requirements, technical and organizational requirements, financial requirements, and requirements of final authorization. The rule stipulates that an applicant shall submit to ERO confirmation that the project complies with the Kosovo Energy Strategy and adheres to all applicable criteria, including those related to safety, security, and financial. Any project must also comply with EU technical standards.

The Final Authorization has defined terms for the construction to happen, which are issued as part of the Decision of the Regulator Board. If the applicant does not construct the plant based on the terms defined, the Authorization can be withdrawn by the Regulator. The time for starting the construction and completing the project are defined by the Regulator's Decision, subject to specific project characteristic.

The Final Authorization is the document which allows the applicant to start the construction of the renewable energy source generator.

The Rule also launches simplified procedures and criteria for granting the right to construct for the self-consumption generators (Prosumers). The procedure based on this Rule is described in detail in the following chapter.

## **RULE ON SUPPORT SCHEME**

The Rule on Support Scheme No. 10/2017, adopted by ERO on April 27, 2017 defines the regulated mechanisms for supporting electricity generated from RES. According to the rule, all RES projects admitted by the Support Scheme are guaranteed to be paid the applicable Feed-in Tariff (FiT) for the appropriate technology.

To be eligible for the Support Scheme, a RES generating facility must generate electricity from one or more of the eligible RES, be located in the territory of Kosovo, and be equipped with new and unused generation equipment. Eligibility for the Support Scheme is closely connected with authorization for constructing new generating capacities process, since only the applicant who applies to ERO to obtain the authorization may apply to be admitted to the Support Scheme.

As noted above, the Notice for Decision on Preliminary Authorization or the Decision on Final Authorization issued by ERO also determines the eligibility of the applicant to the Support Scheme and associated FiT.

The Support Scheme rule determines the maximum size of a single photovoltaic project eligible for the scheme to 3 MW installed capacity.

When the targets set pursuant to the relevant Administrative Instruction for setting targets as issued by MED are fulfilled, ERO will inform all new applicants that FiTs are no longer guaranteed. Starting from the moment when the available targets are free, the Applicant shall be notified in writing by ERO. In accordance with the Article 8 of the Support Scheme rule, ERO creates a register of the applications admitted to the Support Scheme and the RES Generating Facilities which are pending to be admitted to the scheme. The applications considered as “pending applications” shall be registered in the Waiting List according to the date of issuance of the Notice for the Decision on Preliminary or Final Authorization.

Solar photovoltaic projects admitted to the Support Scheme are entitled to sell their electricity output to the Market Operator through a Power Purchase Agreement for a period of 12 years using the FiT. They will be liable for 25% of their total imbalance costs, have priority in connection to the relevant network, and priority dispatch. The Power Purchase Agreement (PPA) is the commercial contract according to which the generator sells the electricity generated from RES generator. Under the Rule on Support Scheme the Market Operator is required by Regulator to adopt a template of the Power Purchase Agreement. The Market Operator is the entity to enter into such agreements with the generators of renewable energy sources. The Power Purchase Agreement contemplates necessary provisions which regulate the effectiveness of the agreement, the invoicing and payments relations, the balancing responsibilities, and other necessary provisions for RES generators

The additional costs incurred to support the development of RES projects admitted to the Support Scheme are compensated through the Renewable Energy Fund, managed by the Market Operator. Funding of the Renewable Energy Fund is provided through a Renewable Energy Charge applicable at transmission level to all electricity suppliers proportionally to their individual demand in total electricity consumption in Kosovo.

## FEED-IN TARIFFS

The initial Feed-in Tariffs (FiT) were adopted by the Board of Energy Regulatory Office on May 19, 2016, through the Decision No. V\_810\_2016. The Feed-in Tariffs apply to all installed generating capacities with new equipment, whilst for solar panels/photovoltaic the equipment must also be recyclable. On November 22, 2019, the Board of Energy Regulatory Office adopted Decision No. V\_1204\_2019 on FiT for additional 20 MW of photovoltaic capacity increased by AI (MED) No. 05/2017.

**Table 5 Level of Feed in Tariffs set for Renewable Energy Sources**

Decision / Administrative Instruction	Feed-in Tariff [Euro/MWh]	Photovoltaic target [MW]	Duration of PPA [years]
<ul style="list-style-type: none"> <li>• ERO Decision No. V_673_2014 (23.12.2014) on FIT</li> <li>• ERO Decision No. V_810_2016 (19.05.2016) on FIT</li> <li>• AI (MED) No. 01/2013 on Renewable Energy Source Targets</li> </ul>	136.4	10	12
<ul style="list-style-type: none"> <li>• ERO Decision No. V_1204_2019 (27.11.2019) (Temporary Suspended)</li> <li>• AI (MED) No. 05/2017 on Renewable Energy Source Targets</li> </ul>	85.00	30	12

Eligible applicants shall submit the written request for admission to the Support Scheme to the Regulator by filling Annex I of Rule on Support Scheme.

## SELF-CONSUMPTION GENERATORS

Self-Consumption Generators are the generating generators which can provide the generated energy at the electricity grid for future consumption or pay to the supplier the consumed energy in the event of negative balance.

The legal or physical body which plans the construction of new generation capacities for self-consumption is obliged to submit a written request to the Regulator in accordance with Chapter VI of the Rule on Authorization Procedure for construction of new Generation Capacities from Renewable Energy Sources.

Following the receipt of relevant evidence, Regulator evaluates that they are completed, and it shall issue a decision related to construction of new generation capacities for self-consumption.

The Self-consumption Support Scheme envisages that:

- Suppliers offtake all electricity produced and deliver all electricity consumed by Prosumers within a Billing Period;
- Suppliers account for the Prosumer Balance of the Billing Period, based on which the monthly invoice is prepared;
- If the Prosumer Balance is positive, then the Prosumer is credited in energy (kWh) in the next Billing Period;

- Any outstanding positive Balance on the last Billing Period of a Calendar Year is reset to zero (0 kWh) without compensation from the Supplier; and
- If the Prosumer Balance is negative, then the Supplier invoices the Prosumer for the value of the Prosumer Balance.

Suppliers are obliged to enter into a Prosumer Agreement with any Prosumer with whom they have an electricity supply contract, under the terms and conditions specified in this Rule.

The Prosumer Agreement sets, among others, the obligation for the supplier to offtake all electricity generated by the Prosumer. Suppliers are obliged to enter into a Prosumer Agreement with any Prosumer with whom they have an electricity supply contract.

### **Current limitations applicable to Prosumers**

The Article 2 of the Rule on Support Scheme has following definitions:

- **Prosumer** - is an electricity customer who is at same time and at the same site the owner of a **Micro RES generating facility**, connected to the grid and having right to self-consume the generated electricity as well as to deliver the excess of generated electricity to the supplier; and
- **Micro RES Generating Facility** – means a Generating Facility connected to the network with a capacity up to 100 kW ( $\leq 100$  kW).

Additionally, Article 20 of the Rule on Support Scheme states the following:

“Any electricity customer **connected to the low voltage distribution network** can apply to its Supplier to obtain the status of a Prosumer...”.

As a result of the above definitions, installed capacity of prosumer is limited to 100kW connected to low voltage distribution network (0.4kV) and this creates a serious limitation to further expansion of this RES segment, especially with private businesses.

## **REGULATED FRAMEWORK**

Small and Large RES Generating Facilities which are not part of the Support Scheme<sup>1</sup> may sell their electricity output under a Regulated Framework or under market-based unregulated conditions.

RES Generating Facilities who wish to operate under the Regulated Framework shall submit a written request to the Regulator, in accordance with Annex 2 of this Rule of Support Scheme and the Regulator shall inform the RES Generating Facility whether the request for admission to the Regulated Framework is granted.

### **Rights and Obligations of RES Generating Facilities under the Regulated Framework**

RES Generating Facilities not admitted to the support scheme who choose to sell their electricity output under a Regulated Framework shall:

---

<sup>1</sup> According to ERO the “Support Scheme” here is understood as Feed-in Tariff, therefore the Regulated Framework is one of the instruments of the Support Scheme.

- Be entitled to sell their electricity output to the Market Operator through a Power Purchase Agreement at the relevant price (referent) set annually by ERO;
- Be liable for all of their imbalance costs except RES Generating Facilities with an installed capacity lower than 500 kW;
- Priority in examining the application for connection to the relevant system;
- Be entitled to priority dispatch.

The sale of electricity to the MO shall be covered by a Power Purchase Agreement, which shall be concluded between the RES Generating Facility, in accordance with the Regulated Framework and the Market Operator.

According to the Regulated Framework, Power Purchase Agreements for RES Generating Facilities shall have a minimum duration of one (1) year and may last up to the validity period of the RES Operators generation license issued by the Regulator. Should the RES Operator not be required to obtain a Generation License, the duration of the Power Purchase Agreement shall be limited to a maximum of fifteen 15 years.

Alternatively, RES Generating Facilities may operate as independent power producers in the Kosovo electricity market, under market-based unregulated conditions.

#### **METHODOLOGY ON CALCULATION OF REFERENCE PRICE FOR ENERGY GENERATED FROM RENEWABLE SOURCES**

The purpose of this methodology is to define the method of determining the reference price for energy generated from renewable energy sources (RES). This price will be applied by the Market Operator for the energy sold to the energy supply operators. It will also be applied for the sale and purchase of energy from RES, according to the regulated framework. Moreover, the methodology defines the basic principles based on which the reference price will be calculated and the method of calculating the reference price.

#### **RENEWABLE ENERGY FUND**

Renewable Energy Fund is provided through a Renewable Energy Charge applicable at transmission level to all suppliers of electricity in Kosovo. The additional costs incurred to support the development of RES projects admitted to the Support Scheme is compensated through the Renewable Energy Fund, managed by the Market Operator (MO). The MO reports to the Regulator on the operation of the Renewable Energy Fund on a quarterly basis.

The Renewable Energy Fund finances the costs associated with:

- a) The difference between the Reference Price and the Feed-in Tariff; and
- b) The compensation for the imbalance costs.



## **OTHER RELEVANT RULES**

### **Rule on Licensing Energy Activities in Kosovo**

Rule on Licensing Energy Activities in Kosovo, adopted by Regulator on March 2017, establishes the procedure for licensing energy enterprises in Kosovo to perform energy activities.

Article 3 defines the type of the licenses the Regulator issues and clarifies which energy activities does not need license. The rule further sets the procedure on issuance of the licenses, the application procedure, the terms and conditions of licenses, as well as the monitoring of the activities of the energy companies.

The Regulator may perform inspecting visits to the facilities of the generators and to documents of the company performing generation of electricity.

The License for Generation of electricity is required for generators with an installed capacity of over 5 MW. The license has a duration of maximum 40 years, depending on the lifespan of the assets used for performing generation. Regulator performs monitoring based on the data submitted by the licensee and based on the information received by the Market Operator.

### **Rule on Resolution of Complain and Disputes in the Energy Sector**

Adopted in March 2017 by the Regulator, this Rule sets out the conditions and procedures for submitting, reviewing and resolving customer complaints against licensees in the energy sector, between energy licensees and connecting third parties to the transmission system distribution of electricity, thermal energy and natural gas as well as cross-border transmission, electricity and gas flows.

### **Transmission Grid Connection Methodology**

Principles on determination of transmission and market use of system tariffs and connection taxes, is a regulatory act adopted by the Regulator in January 2017. The purpose of this act is to compile Methodology on Determination of Transmission System Operator Tariffs, System Operator Tariffs, Market Operator Tariffs, and Taxes for Connection to Transmission System. The methodology mentioned above shall be in compliance with General Conditions of Energy Supply and Rule by Transmission System Operator and Market Operator Maximum Allowed Revenues, approved by Regulator. Article 11 sets the principles for setting the price for the connection of new generation capacities to the transmission network, whilst Article 12 and 13 establish the methodology for deciding on taxes for connection of new generation capacities. The transmission connection fee depends on the offer which is provided by the transmission system operator.

### **Distribution Grid Connection Methodology**

Principles of determination of distribution use of system tariffs and connection taxes is a regulatory act adopted by the Regulator in January 2017. The purpose of these rules is for distribution system operator to compose methodologies for determining the use of system tariffs for distribution and for determining taxes for connection to the system for distribution.

The above methodologies shall be in accordance with the General Conditions of Energy Supply and the Distribution System Operator Determinations Maximum Allowed Revenue, approved by Regulator. Article 14 sets the procedure of application when the distribution system operator receives

an application for connection to the distribution network and the offer which is issued by the distribution system operator. The distribution connection fee depends on the offer which is provided by the distribution system operator.

## **KOSOVO FISCAL POLICY FOR RES / PV**

### **VALUE ADDED TAX (VAT)**

Kosovo applies Law No. 05/L-037 on Value Added Tax (hereinafter: Law on VAT) which entered into force on September 1, 2015. According to Article 26 of the Law on VAT, the standard rate of VAT is 18%. With regards to solar PV systems (panels and all accompanying components like batteries, charge controller etc.) every and each component is charged with 18% VAT and there is no exemption or applicable reduction of the rate. This VAT rate is paid when the goods enter Kosovo, during the procedures of customs clearance. The VAT paid for solar PV systems is considered a deductible tax, hence, the businesses can later on deduct it in accordance with Articles 36-39 of the Law or request a VAT refund from the Tax Administration of Kosovo in accordance with Article 40 of the Law.

Article 29, para. 1.11 of the same Law provides for a complete exemption from VAT on imported goods, specifically for raw materials used in the production process. That is, if a Kosovar company imports components of solar panels like, the solar cells, frames, junction box and the rest, it can declare these parts as raw material and receive an exemption from VAT on imported goods and then it can assemble all the parts to form the solar panels. Therefore, any company can apply for VAT exemption on imported goods for raw materials, on a yearly basis and the request shall be submitted in accordance with Article 48 para. 3 of the Administrative Instruction MoF- No. 03/2015 for Implementing the Law No. 05/L-037 on Value Added Tax.

### **CUSTOMS**

The customs duties, including the procedure and the rights and obligations of the involved parties are governed by the Code No. 03/L-109 Customs and Excise Code of Kosovo, Administrative Instruction No 11/2009 on Implementation of Customs and Excise Code and all the accompanying amendments.

In general, any good that enters Kosovo and supersedes the amount of EUR 22 has import obligations, thus customs duty tax is applicable amounting to 10% of the total value.

The goods enter the border crossings and are then sent to the customs terminals for customs clearance of cargo. There are two available allowed options where goods can undergo customs clearance: a) at the nearest terminal from the point of entry or b) at the terminal closest to the headquarters where the company is registered.

With regards to solar PV panels, all these goods despite the country of origin, are exempted from custom tax duty and they are registered with the goods code as 8541 4090 00.

In general, despite the customs duty tax of 10% which is the norm for imported goods of non-preferential origin, there is preferential status for certain goods. That is, application of preferential customs duties at import for goods with origin from countries that have ratified the agreement on amendment of and accession to the Central European Free Trade Agreement (CEFTA 2006) is applicable:

- Since 26 July 2007 for goods with origin from: Republic of Albania (AL), the Republic of Moldova (MD), the Republic of Montenegro (ME), the Republic of Macedonia (MK);
- Since 24 October 2007 for goods with origin from Republic of Serbia (XS);
- Since 22 November 2007 for goods from Bosnia and Herzegovina (BA); and
- Since 01 July 2013 the Republic of Croatia is left CEFTA-2006, according to information Nr.372/28.05.2013.

To receive the preferential status in the context of this Agreement, the origin of products is evidenced by a movement certificate EUR I or "declaration of origin" provided by exporters in accordance with Article 21 (1) Title V, as described in the Agreement CEFTA-2006.

The application of preferential customs duties on import of goods originating from countries which have ratified the Stabilization and Association Agreement between the Republic of Kosovo, on one side, and the European Union and the European Atomic Energy Agency (MSA 2016), on the other side by law No. 05 / L -069 according to the relevant annexes, is applicable:

- Since 01 April 2016 for goods with origin from: Austria (AT), Belgium (BE), Bulgaria (BG), Croatia (HR), the Republic of Cyprus (CY), Czech Republic (CZ), Denmark (DK ), Estonia (EE), Finland (FI), France (FR), Germany (DE), Greece (GR), Hungary (HU), Ireland (IE), Italy (IT), Latvia (LV), Lithuania (LT ), Luxembourg (LU), Malta (MT), the Netherlands (NL), Poland (PL), Portugal (PT), Romania (RO), Slovakia (SK), Slovenia (SL), Spain (ES), Sweden (SE ) and United Kingdom (GB).

To receive the preferential status in the context of this Agreement, the origin of products is evidenced by a movement certificate EUR I or "declaration of origin" provided by exporters in accordance with Article 21 (1) Title V, as described in the Agreement on Stabilization and Association (MSA 2016).

Beside the preferential status under CEFTA and the Agreement on Stabilization and Association, since January 9, 2019 there is a free trade agreement between the Republic of Kosovo and the Republic of Turkey with a Decree no. 122/2019.

#### Safeguard measures on imports

In July 2018, the Law No. 06/L-040 on safeguard measures on imports entered into force, which allows the relevant public institutions to apply a safeguard measure. Additionally, in December 2018 entered into force the Administrative Instruction (MTI) No. 19/2018 on the Content of the Application Form for the Initiation of Investigation on Safeguard Measure on Imports. According to Article 1 of the Law, a safeguard measure can be applied on an imported product if such product enters the territory of Kosovo in an increased quantity, absolute or relative to domestic production, and/or with terms or conditions which cause or threaten to cause serious damage to the domestic industry which produces similar or competitive products. However, according to Article 4 of the Law such measure shall be temporary and constitutive an ad valorem safeguard measure.

## INSTITUTIONAL FRAMEWORK

### KEY ELECTRICITY MARKET PARTICIPANTS

#### KOSTT- TRANSMISSION, SYSTEM AND MARKET OPERATOR J.S.C.

KOSTT J.S.C is electricity Transmission, System and Market Operator of the Republic of Kosovo, a public company with 100% of shares owned by the Republic of Kosovo. According to Law on Electricity no. 05/L-085 approved in 2016, the rights of the shareholder will be exercised by the Assembly of the Republic of Kosovo. KOSTT has the following two roles: (i) Market Operator, and (ii) Transmission System Operator.

The Market Operator (MO) is responsible for the organization, operation, and management of the electricity market in the entire territory of the Republic of Kosovo in accordance with the Market Rules approved by the Regulator. The activity performed by the Market Operator is related to the management of the electricity market and the preparation of financial reports for market participants according to the Final Settlement, without including the purchase or sale of electricity, in accordance with the provisions of market rules.

The Transmission System Operator (TSO) is responsible for the operation, maintenance and, if necessary, development of the transmission network in a certain area, as well as where possible interconnectors with other systems, and for guarantee the long-term ability of the grid to meet the requirements for electricity transmission as well as system balancing.

KOSTT manages the Transmission System of the Republic of Kosovo, operating with high voltage 400kV, 220kV and 110kV lines. The transformers connected to the distribution network: 220/35/10 kV and 110/35/10 (20) kV also belong to the transmission system. The responsibility of KOSTT is to transmit electricity safely and reliably from generating units to the distribution system, 24 hours a day, 365 days a year.

Currently, the Kosovo's transmission network is connected to neighboring countries through eight cross-border lines. As a result of the central geographical position of Kosovo, the Transmission System operated by KOSTT, although small in size, represents a very important transmission hub in Southeast Europe.

The transmission system operators OST of Albania and KOSTT of Kosovo signed on October 5, 2020 the Shareholders' Agreement and Articles of Association for the establishment of the power exchange company that will operate the short-term electricity markets in Albania and in Kosovo. The power exchange operator, called ALPEX, has its main seat in Tirana and will operate the day-ahead market coupling between Albania and Kosovo soon after its operationalization. ALPEX is expected to extend its services to the intraday market segment in the future.

#### KEDS - KOSOVO ELECTRICITY DISTRIBUTION SERVICE J.S.C.

Distribution System Operator (DSO) - is responsible for the operation, maintenance and, as needed, development of the distribution system in a given area, as well as where possible its interconnectors with other systems, as well as for providing capacity long-term system to meet reasonable electricity

distribution requirements. The DSO also provides management of customer meter databases and collection of meter readings for final reconciliation purposes.

Kosovo Energy Distribution Services (KEDS) is a joint stock company that operates throughout Kosovo. KEDS J.S.C. has the exclusivity of electricity distribution. KEDS J.S.C. was established in 2009, while its operational activities were initiated on May 8, 2013, when it finally split from KEK J.S.C. KEDS J.S.C. owned by Çalik Holding and Limak.

KEDS J.S.C. under the licenses from Energy Regulatory Office operates with electricity distribution to the customers. To operate in the most efficient way KEDS is distributed in seven divisions located in seven major cities of Kosovo and 30 sub districts.

KEDS does the distribution of electricity up to last customer, manages and maintains assets in terrain. Within the KEDS are included lines of medium voltage 35 kV, 20kV, 10 kV, 10 kV with possibility of transfer to 20 kV, 6 kV and 3 kV (kilovolt) together with respective substations, substations 35/10 kV/kV, 10(20)/0.4 kV/kV, 10/0.4 kV/kV, 6/0.4 kV/kV, lines of low voltage 0.4 kV, and also over 596 thousand individual meters of customers.

#### **KESCO - KOSOVO COMPANY FOR SUPPLY OF ENERGY J.S.C.**

Suppliers are energy companies licensed by the regulator to carry out the activity of supplying customers in Kosovo. Electricity supply is an activity independent of the activity of transmission and distribution of electricity and is related to the purchase, sale, including resale of electricity to consumers. To date ERO has licensed eight supply companies in Kosovo but only KESCO is active in the market.

KESCO (Kosovo Company for Supply of Energy) was founded by the Limak – Çalik consortium in January of 2015. One of the reforms undertaken by the authorities of the energy sector in Kosovo was the unbundling of the suppliers, and KESCO is one of those reforms that aim towards the energy market liberalization.

KESCO serves around 600 thousand consumers. In order to serve these costumers, KESCO has expanded its services in all cities around Kosovo, which are coordinated by the seven (7) main districts. Based on their nature, consumers are divided into households, commercial and industrial, served by specialized departments.

## **KEY PUBLIC ENTITIES**

### **KOSOVO ASSEMBLY**

The Assembly is the legislative institution of the Republic of Kosovo, elected directly by the people. It has 120 MPs. During their parliamentary mandate, MPs conduct a series of functions. They review and adopt draft laws and decisions, represent, and defend rights and interests of the citizens, oversee the work of the government and independent institutions, and they approve the budget of Kosovo. In the energy sector the Assembly also adopts the Kosovo Energy Strategy.

Within its scope and responsibilities, the Committee on Economy, Employment, Trade, Industry, Entrepreneurship and Strategic Investments considers all the matters that are related to the field of

energy, mines, postal sector, telecommunication, information and communication technology, digital economy, trade, industry, tourism, consumer protection, oil, strategic goods, economic zones, industrial ownership, entrepreneurship, employment relationship, employment, safety and health at work, social dialogue, private sector, foreign investments and strategic investments, as well as monitoring public enterprises.

Independent bodies such as: Energy Regulatory Office (ERO), and KOSTT - Transmission, system and market operator, report to the Committee on regular and ad-hoc basis.

### ENERGY REGULATORY OFFICE (ERO)

The Energy Regulatory Office (ERO) was established in June 2004, with the promulgation by the Assembly of Kosovo of the Law on Energy Regulator. The Energy Regulatory Office is an independent body, which has the duty to regulate activities in the energy sector in Kosovo, including electricity, district heating and gas, in accordance with the obligations arising from the Energy Community Treaty (ECT).

ERO has the authority to issue licenses and monitor whether these licenses are respected by energy companies, to approve the tariffs for activities of public services, to impose obligations on the supply of the population, to resolve disputes and to draft secondary legislation for the energy sector.

ERO is also responsible for creating the regulatory framework, which ensures transparent and non-discriminatory functioning of the energy market, based on the principles of the free market. It implements transparent and open criteria for granting authorizations for construction of new energy facilities, licenses to energy enterprises, including the authority to grant, modify, suspend, transfer, withdraw, supervise, and control whether the energy enterprises comply with these licenses.

ERO also has the competences to set in prior the principles and methods of determining the prices and later to approve tariffs for regulated energy services. This function also includes tariff monitoring, dispute resolution, service quality and standards for performing these activities. While carrying out its duties and functions, ERO cooperates with energy enterprises and ministries, especially with the Ministry of Economy and Environment.

ERO is funded by license fees, which enable this office to act as a financially independent regulatory body. ERO helps and ensures that Kosovo's regulatory framework is in line with the 'acquis Communautaire' (summary of EU legislation) on energy.

### MINISTRY OF ECONOMY AND ENVIRONMENT (MEE)

The Ministry of Economy and Environment (MEE) is the line ministry responsible for renewable energy strategy and policy. In accordance with Article 13 of the Law on Energy, MEE is responsible for the development of the ten-year renewable energy action plan and the determination of renewable energy targets in full compliance with the requirements of the EU directive on renewable energy. MEE drafts sub-legal acts (Administrative Instruction) on promotion of use of RES in order to identify measures for accomplishing renewable energy targets. MEE is also responsible for concluding agreements for international cooperation in project development and common support schemes for renewable sources.

MEE, through Energy Department, is in charge for the policymaking for the energy sector. From the policy perspective MEE adopted several acts which structure the main basis for support of renewable technology in general. As per the above MEE is responsible for setting the state RES targets to be achieved, which is done through the Administrative Instruction No. 05/2017 on Renewable Energy Source Targets and MED also adopted the Administrative Instruction No. 06/2017 on Utilization and Support of Energy Generation from Renewable Sources. MEE has also set up a One Stop Shop for RES.

MEE is also responsible for issuance of consents and permits related to environment, construction, and water. MEE reviews the Environmental Impact Assessment (EIA) study which is prepared by applicants interested to invest in the renewable technology and based on this review issues the environmental consent. MEE also sets the procedure through secondary legislation and instructs Municipalities to issue Municipal Environmental Permits.

#### MINISTRY OF FINANCE

MF is responsible for the fiscal policy and under its umbrella are customs and tax authorities. Currently only photovoltaic panels are exempted from custom duty. See Fiscal Policy section of this report.

#### MINISTRY OF TRADE AND INDUSTRY

MTI is mandated to support small and medium enterprises of Kosovo, register new companies in Kosovo, as well as through the Kosovo Investment and Enterprise Support Agency (KIESA) provides guidelines for investors. The KIESA also administers strategic investment procedure based on Law on Strategic Investments in the Republic of Kosovo. There are number of photovoltaic projects being reviewed by KIESA and Operational Groups.

#### MINISTRY OF AGRICULTURE, FORESTRY AND RURAL DEVELOPMENT (MAFRD)

MAFRD through Agency for Agricultural Development supports farmers and agricultural processing facilities with grants that have RES integrated as part of the scoring system. As a result of grant support scheme over past five (5) years hundreds of farmers and processing facilities have invested in RES in particular small scale off-grid photovoltaics systems. MAFRD is expected to continue with this measure in years to come and is currently exploring ways to generate additional revenues for the farmers i.e., revenues from sale of surplus electricity. MAFRD within its structure has the Agency of Forestry which is responsible for the management and issuance of the right to use the forest land

#### MINISTRY OF LOCAL GOVERNMENT ADMINISTRATION

has the mandate to regulate through secondary legislation to issue right for use the local public land. Based on the law on use of Municipal Immovable property the Ministry prepares, and Government adopts the secondary legislation which regulates the procedure for the right to use the Municipal land. Ministry of Local Government Administration also monitors the implementation of legislation by the Municipalities.

#### MUNICIPALITIES

Municipalities are responsible for adopting municipality development plans which amongst other, envisage the areas where the construction of power plants should happen. Municipalities have

competence for issuance of construction permits for generation capacities of less than 10 MW as well as environmental permits for which the environmental impact assessment study is not needed.

#### ASSOCIATION OF MUNICIPALITIES OF KOSOVO

Association of Municipalities of Kosovo as a non-governmental organization is represented by Municipalities and amongst others has the mandate to address concerns of Municipalities for more efficient local governance in order for better services to citizens.

#### KOSOVO COMPETITION AUTHORITY

The Competition Authority is a legal entity with independent public authorizations in the performance of its duties set out in the Law on Protection of Competition. The Competition Authority reports directly to the Assembly of the Republic of Kosovo. The Competition Authority ensures that the energy market allows for an open competition, by prohibiting cartels and abuses of dominant position, and ensuring that prohibited concentration of enterprises does not take place.



## **ADMINISTRATIVE PROCEDURES FOR PV PROJECT DEVELOPMENT**

This chapter of the report builds on top of what has already been described under previous chapter Legal, Policy and Regulatory Framework for PV projects in Kosovo, and describes in more depth the application procedure and required supporting documents for developers to obtain Authorization for construction of new photovoltaic plants.

The chapter is divided into three parts:

- The first part describes the Authorization Process for Large PV, and Small PV generation.
- The second part describes Authorization Process for Small PV Self-consuming generators (Prosumers).
- The third part describes permitting process for self-consuming generators that are not connected to the grid.

### **AUTHORIZATION PROCESS**

The Rule on Authorization Procedure for Construction of New Generation Capacities from Renewable Energy Sources (adopted by ERO on April 27, 2017) sets out the criteria and procedure for issuing permits for RES to build new generation capacity.

The Rule offers three options for application procedure, for on grid installations:

1. Application for Authorization – Large Scale Generators, over 100 kW (Appendix 1);
2. Application for Authorization – Small Scale Generators, up to 100 kW (Appendix 2);
3. Application Procedure for Self-consumption Generators (Chapter VI).

Application for Authorization based on Appendix I of the Rule requires developers to submit the following documentation:

- General Information of the applicant;
- Specific information of the generators, by units;
- General Requirements;
- Technical and Organizational Requirements;
- Financial Requirements;
- Requirements for Final Authorization.

Detailed list of required documents to be submitted by the developer to obtain the Preliminary, respectively the Final Authorization are described in Table 6 and Table 7 below. The submission, review and approval process are presented in Figure 10.

The Table 8 further lists documents required to obtain additional relevant consents, permits and approvals.

**Table 6 List of Documents for Preliminary Authorization (Appendix I of the Rule)**

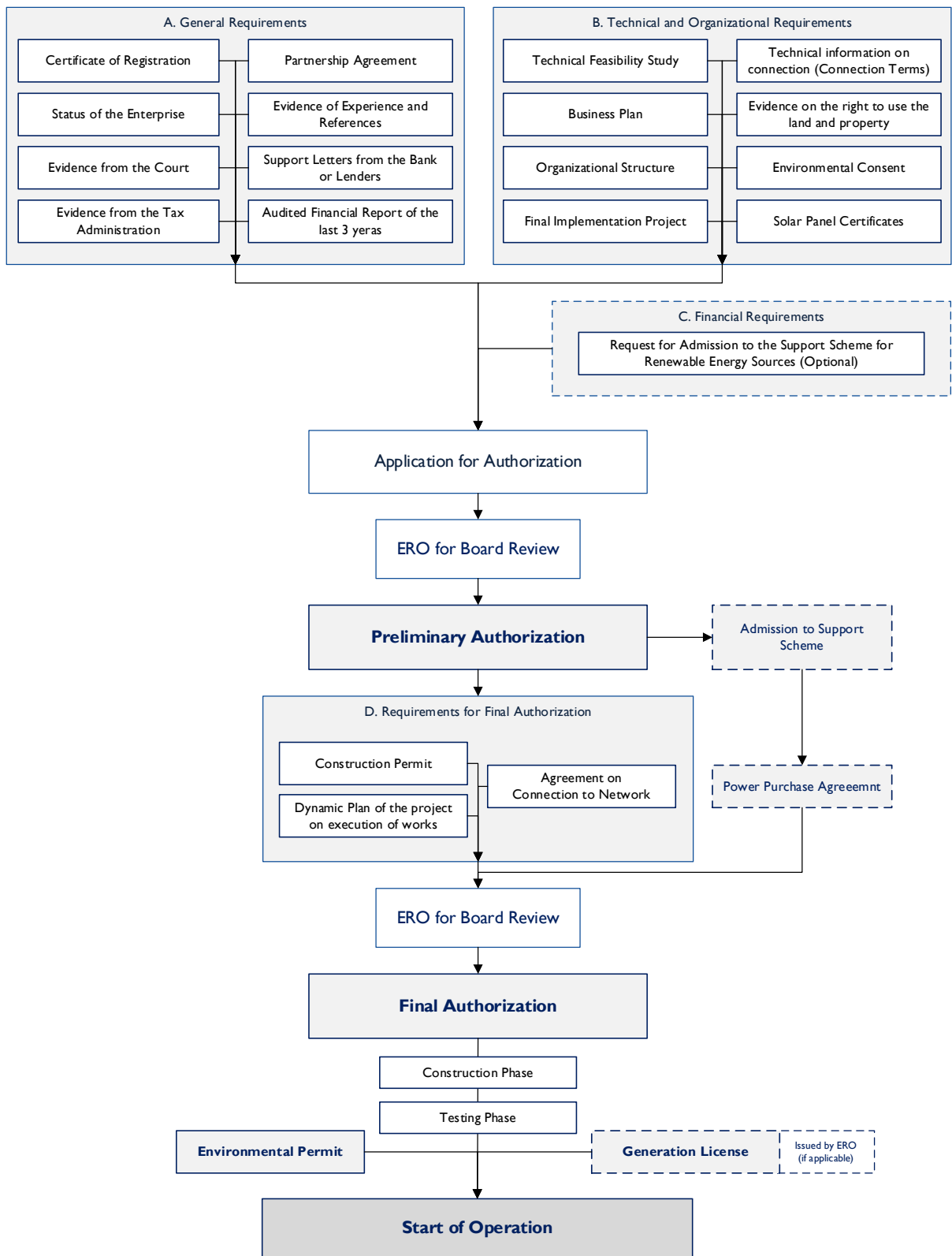
<b>A General Requirements</b>	
No.	Evidence/documents to be attached:
1	Certificate of Registration as a business company issued by KBRA.
2	Evidence on establishment of the enterprise (Status of the enterprise)
3	Evidence from competent court proving that the applicant is not involved in a liquidation/ bankruptcy procedure; that his/her business is not administered by the court and his/her commercial activities are not suspended;
4	Evidence from competent authority proving that the applicant meets legal obligations on tax payments in the country where the same is registered as a legal person;
5	<i>In case of Partnership: Evidence in certain areas related to implementation of the contract/s</i>
6	<i>Reference on the business experience of the applicant or partners in the field of RES or similar</i>
7	<i>Support letter from the bank or any lender.</i>
8	<i>Audited Financial Report of the last three (3) years, certified by competent institution or certified Financial Auditors.</i>
<b>B Technical and Organizational Requirements</b>	
No.	Evidence/documents to be attached:
9	<i>Technical Feasibility Study based on real data and measurements carried out in project implementation area, including: general description of the project, climate and meteorological conditions for the project area according to the type of generator, technical description of selection of each element of the generator based on the above data: calculations on which the selections are based, the study, calculations and selection of equipment for connection to energy network, a study and analysis of geological-engineering conditions of the area where the project shall be implemented as well as Organizational Structure of the Applicant and CVs of the staff. The Feasibility Study shall, among other, include the Business Plan (Total cost of investments and financing manner, Economical-Financial Evaluation of the Project).</i>
10	Final Implementation Project
11	Technical information on connection issued by KEDS or KOSTT, depending on the level.
12	Evidence on the right to use the land and property state of the land that shall be used for construction of the generator (Decision on granted consent by municipal body, possession list, plan copies, agreements/contracts on use of private/public land etc.);
13	Environmental Consent by MESP
14	Evidence on type, safety, quality of solar/photovoltaic panels and certificate on recycling (TUV Certificate).
<b>C Financial Requirements</b>	
No.	Evidence/documents to be attached:
15	Request for Admission to the Support Scheme for Renewable Energy Sources.

**Table 7 List of Documents for Final Authorization (Appendix I of the Rule)**

<b>D Requirements for Final Authorization</b>	
No.	Evidence/Documents to be attached for conversion of Preliminary Authorization into Final Authorization
1	Agreement for Connection to the network, depending on the voltage level.
2	Water Consent or Water Permit by MESP, in the event of hydro power plants
3	Construction Permit issued in accordance with Law on Construction in the Republic of Kosovo.
4	Dynamic Plan of the project on execution of works

**Notes:**

- If developer applies for admission to the Support Scheme, and the admission is granted by the ERO Board as part of Decision on Preliminary Authorization, then the PPA is guaranteed for all the generating units which have been admitted to the Support Scheme, and the PPA with Market Operator shall be concluded within 30 days following the admission to the Support Scheme.
- For generators <100kW the applicant follows a simplified process as in Appendix 2 of the Rule on Authorization.



**Figure 10 Process Chart for Authorization Procedure**

**Table 8 List of documents required to obtain other relevant consents, permits, and licenses**

Permits Approvals Consents	Required documents	Responsible entity
<b>Environmental Consent – Ministry of Environment and Spatial Planning</b>		
	Environmental Impact Assessment (Report on EIA) in six copies	Applicant prepares and submits EIA to MESP
	Proof of publication of information	Applicant
	Municipal Assembly opinion	Applicant as issued by the Assembly
	Business Registration Certificate	Applicant, as issued by KBRA
	Possession letter	Applicant
	A copy of the Plan with coordinates	Applicant
	Situation Plan	Applicant
	The right to use the parcels	Applicant
	Payment of the fee for the review of the EIA report	Applicant
	Evidence on the project investment amount	Applicant
	Completed questionnaire	Applicant
<b>Environmental Permit – Ministry of Environment and Spatial Planning</b>		
	Application form for Environmental Permit	Applicant
	Completed application in five copies	Applicant
	Certificate of Business Registration	Applicant
	A copy of Decision of Environmental Consent	Applicant, as issued by MESP
	Occupancy Certificate	Applicant
	Payment of the Fee for the review of the Environmental Permit	Applicant
<b>Construction Permit – Ministry of Environmental and Spatial Planning or Municipality</b>		
	Application for construction permit	Applicant
	A copy of the plan and the certificate of ownership	Applicant
	Legal act establishing the terms of construction	Applicant
	Construction documents in 3 copies and electronic form	Applicant
	Environmental Impact Assessment Decision (if applicable)	Applicant, as issued by MESP
<b>Network Connection - Distribution System Operator</b>		
	Application for connection conditions	Applicant
	Draft Energetic Consent	Distribution System Operator
	Application for Final Energetic Consent	Applicant
	Issuance of the Energetic Consent	Distribution System Operator
	Technical acceptance and approval of the generator	Distribution System Operator
	Agreement for Connection to the distribution network	Applicant / Distribution System Operator
<b>Network Connection - Transmission System Operator</b>		
	Application for connection	Applicant
	Study Design for connection	Transmission System Operator
	Offer for connection	Transmission System Operator
	Agreement for Connection	Applicant / Transmission System Operator
<b>Generation License (applicable for capacities above 5 MW) – Energy Regulatory Office</b>		
	A copy of Business Registration Certificate	Applicant
	The Statute of the Business Registration Certificate	Applicant
	Business plan, related to energy activities to be covered by the license which covers at least next 3 years	Applicant
	Audited annual financial statements for the last 3 years	Applicant
	Evidence from financial institution confirming availability of funds for the energy activity	Applicant, as issued by financial institutions
	Certificate from Tax Authorities	Applicant, as issued by tax authorities
	Certificate not being under the procedure of insolvency or liquidation	Applicant, as issued by the competent court
	Applicant experience	Applicant
	CVs of senior management and qualifications	Applicant
	Organizational structure	Applicant
	Payment of the application fee	Applicant
	Evidence of publication of the notice in daily newspapers	Applicant
	Signed Declaration, certifying that the: <ul style="list-style-type: none"> <li>Managers have not been convicted or indicted from criminal offences;</li> <li>No withdrawal of license for the activity applying within last 5 years;</li> <li>The applicant acts in compliance with environmental legislation;</li> <li>Applicant will apply all legislation of the energy sector including, Regulatory rules, technical and commercial codes;</li> <li>Has not committed any offence in Kosovo or abroad in terms of safety and security at work.</li> </ul>	Applicant

## **SELF-CONSUMPTION GENERATORS (PROSUMERS)**

The legal or physical body which plans the construction of new generation capacities for self-consumption is obliged to submit a written request to the Regulator in accordance with Article 25 of the Rule on Authorization Procedure for construction of new Generation Capacities from Renewable Energy Sources.

For applicant (future Prosumer), the entire process has two main phases:

- Phase 1. Authorization for construction of new generation capacities from RES.
- Phase 2. Procedure for admission to Support Scheme.

### **PHASE 1 – AUTHORIZATION FOR CONSTRUCTION**

To obtain the Authorization, the applicant shall submit a written request to ERO with evidence on:

- Annual energy consumption information issued by KEDS;
- Evaluation of annual kWh production from installed generation;
- Consent for connection to the grid, issued by KEDS; and
- Consent from the relevant municipality.

For Phase 1 Authorization Process Chart see Figure 11, and for detailed list of required documents supporting the written request see Table 9.

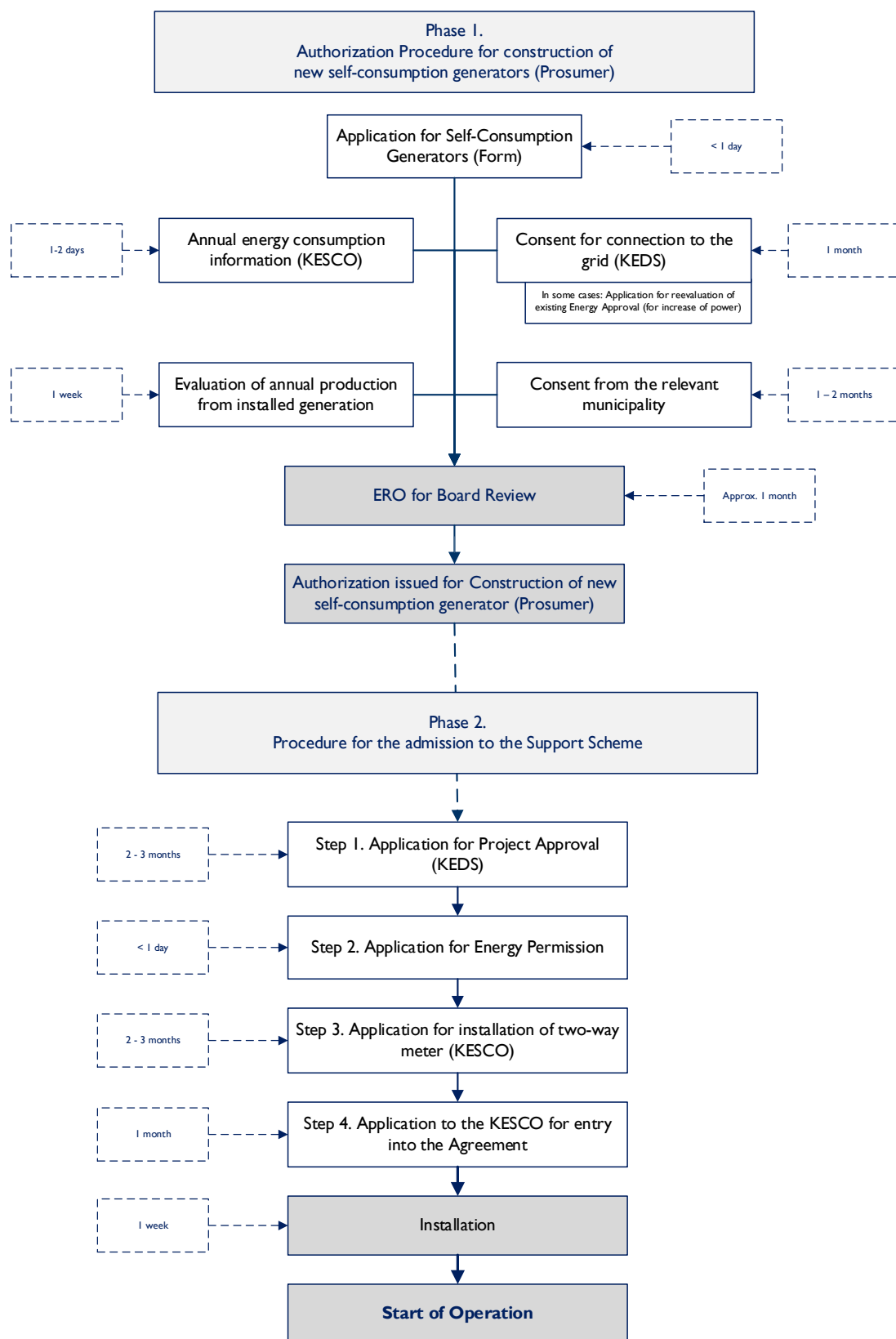
ERO shall issue a decision related to construction of new generation capacities for self-consumption within the legal term stipulated in Article 16 of the Rule.

### **PHASE 2 – ADMISSION TO SUPPORT SCHEME**

The Rule on Support Scheme for renewable energy sources generators establishes that the RES Self-consuming generators are customers that may choose to obtain a Prosumer Status through a Self-consumption Support Scheme.

The Self-consumption Support Scheme envisages that:

- Suppliers offtake all electricity produced and deliver all electricity consumed by Prosumers within a billing period;
- Suppliers account for the Prosumer Balance of the Billing Period, based on which the monthly invoice is prepared, if the Prosumer Balance is positive then the Prosumer is credited in electricity (kWh) in the next billing period;
- Any outstanding positive Balance on the last billing period of a Calendar Year is reset to zero (0 kWh) without compensation from the Supplier;
- If the Prosumer Balance is negative, then the Supplier invoices the Prosumer for the value of the Prosumer Balance;
- Suppliers are obliged to enter into a Prosumer Agreement with any Prosumer with whom they have an electricity supply contract. The Prosumer Agreement sets, among others, the obligation for the Supplier to offtake all electricity generated by the Prosumer.



**Figure 11 Process Chart for Authorization for construction and Admission of Self-consuming generators to the Support Scheme**

**Table 9 List of Documents for Authorization of Self-consuming generators (Prosumers)**

<b>Phase I. Authorization Procedure for Construction of new Self-consumption generators (Prosumers)</b>		
<b>Task 1</b>	<b>Application for Self-Consumption Generators (Form)</b>	
< 1 day	Task 1.1 General Information about Applicant	Task 1.2. Specific Information about Self-Consumption Generator
	<ul style="list-style-type: none"> <li>Name of Applicant</li> <li>Address</li> <li>Telephone number</li> <li>E-mail address</li> <li>Name and Surname of Contact Person</li> <li>Address of the Contact Person</li> <li>Telephone number of the Contact Point</li> <li>E-mail address of the Contact Point</li> </ul>	<ul style="list-style-type: none"> <li>Name of Unit</li> <li>Location</li> <li>Municipality</li> <li>Energy Source</li> <li>Installed Capacity</li> <li>Consumption (Annual)</li> </ul>
<b>Task 2</b>	<b>Annual energy consumption information issued by KESCO</b>	
1-2 days	<ul style="list-style-type: none"> <li>Annual Energy Consumption (kWh)</li> <li>Annual Load (kW) - optional</li> </ul>	
<b>Task 3</b>	<b>Evaluation of annual kWh production from installed generation (PV system supplier)</b>	
1 week	<ul style="list-style-type: none"> <li>Calculation of Annual Energy Production of the proposed PV system, based on:                             <ul style="list-style-type: none"> <li>Site solar potential assessment, Optimal installed capacity, technology / energy yield / cost, storage options, etc.</li> </ul> </li> </ul>	
<b>Task 4</b>	<b>Consent for connection to the grid, issued by KEDS</b>	
1 month	Task 4.1 Consent for Connection to the grid	Task 4.2. (Optional) Application for revision of EEC i.e., Request for increase of Power
	<ul style="list-style-type: none"> <li>Request (Form, Letter?)</li> <li>Client Authorization (when the installer undertakes the administrative procedures)</li> <li>Business Certificate (of installation firm)</li> <li>Copy of Licensed engineer (of installation firm)</li> <li>Technical Report on PV system annual production and its environmental impact</li> <li>Single line diagram for the PV system</li> <li>Technical specifications of equipment (brochures)</li> <li>Cadastral Information (Certificate of Ownership and Copy of the Plan)</li> </ul>	<ul style="list-style-type: none"> <li>Request</li> <li>Client Authorization (when the installer undertakes the administrative procedures)</li> <li>Business Certificate (of installation firm)</li> <li>Diploma of the engineer (of installation firm)</li> <li>Single line diagram of the supply</li> </ul>
<b>Task 5</b>	<b>Task 5. Consent from the relevant municipality</b>	
1-2 months	Task 5.1. Application at the Municipality for Urban Consent	
	<ul style="list-style-type: none"> <li>Request (Form, Letter?)</li> <li>Client authorization (when the installer undertakes the administrative procedures)</li> <li>Cadastral Information (Certificate of Ownership and Copy of the Plan)</li> <li>Municipal approval for construction of the building (Construction Permit)</li> <li>Front page</li> <li>Business Certificate</li> <li>Engineer diplomas</li> <li>Project Scope</li> <li>Technical report</li> <li>Static calculations</li> <li>Bill of materials</li> <li>Technical specifications</li> <li>Drawings / Schemes</li> <li>Declaration of a construction engineer that approves the mounting of the solar modules</li> <li>Business certificates of the construction engineer</li> <li>Construction engineer's diploma.</li> </ul>	

**Table 10 List of documents required for admission to the Support Scheme**

<b>Phase 2. Procedure for obtaining Prosumer status, Net-metering, and Prosumer Agreement</b>	
<b>Step 1</b>	<b>Project Approval (KEDS)</b>
2 – 3 months	Task 1.1 Application for Project Approval <ul style="list-style-type: none"> <li>• Official Request</li> <li>• General and contact information front page</li> <li>• Client's authorization</li> <li>• Municipal consent</li> <li>• Energy approval for the PV system</li> <li>• Cadaster's certificate</li> <li>• Copy of plan</li> <li>• Business certificate of third party</li> <li>• Engineer's diploma</li> <li>• Technical description of the PV system, fire protection, lightening protection, earthing</li> <li>• Project's situation</li> <li>• Single line diagrams of the project</li> <li>• Electrical measurements</li> <li>• Bill of material origin</li> <li>• Technical specification, product handouts</li> <li>• Implementation details</li> </ul>
<b>Step 2</b>	<b>Entrance permission</b>
< 1 day	Task 2.1 Application for Energy permission <ul style="list-style-type: none"> <li>• Official request</li> <li>• Client's authorization for third party</li> </ul>
<b>Step 3</b>	<b>Two-way Meter</b>
1 month	Task 3.1 Application for installation of two-way meter <ul style="list-style-type: none"> <li>• Official request</li> <li>• DSO's technical approval report</li> <li>• ERO's decision on authorization</li> <li>• Client's authorization for third parties</li> </ul>
<b>Step 4</b>	<b>Prosumer Agreement</b>
1 month	Task 4.1 Application to the KESCO for entry into the Agreement <ul style="list-style-type: none"> <li>• Official request</li> <li>• DSO's technical approval report</li> <li>• ERO's decision on authorization</li> <li>• Client's authorization for third parties</li> </ul>



## SELF-CONSUMPTION GENERATORS THAT DO NOT FEED TO THE GRID

The existing legislative framework is applicable only to projects connected to the grid, therefore generators that do not feed electricity to the grid are not obliged to acquire an authorization for construction of new generator from ERO.

These projects, if installed on rooftops, need to acquire a municipal permit. However, the experience from majority of implemented projects shows that no such permit was obtained, probably because there are no clear instructions from the ERO or municipalities.



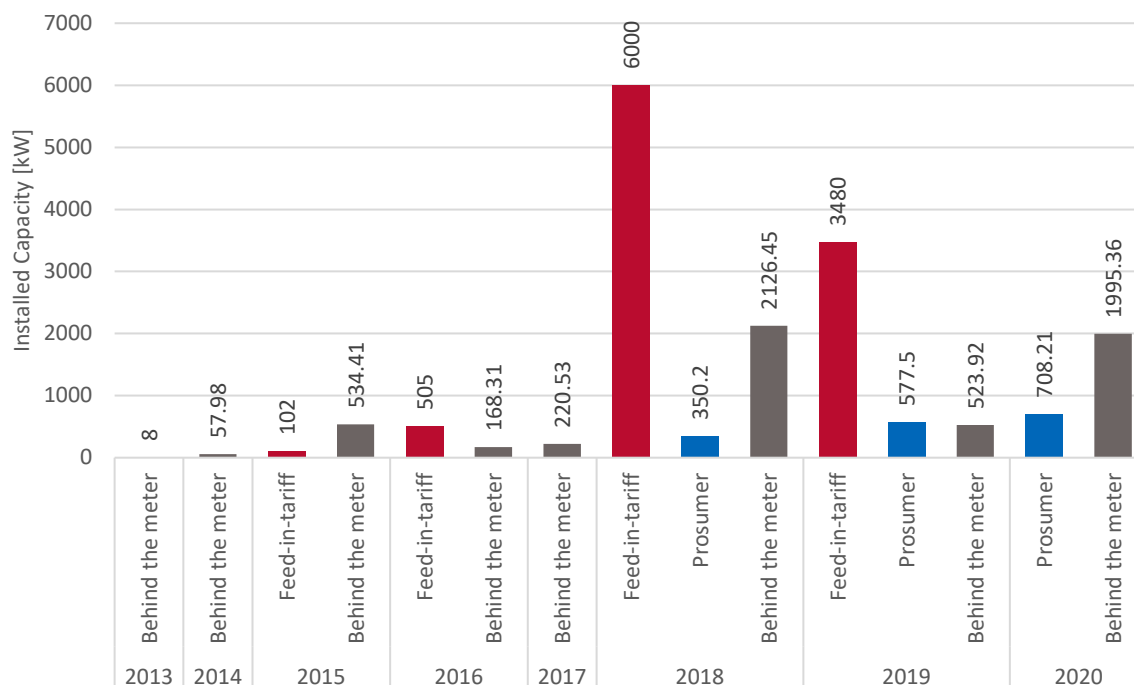
**Figure 12 Albi Mall 500 kW behind the meter solar PV installation**

Another important fact is that these installations are not reported anywhere, and no institution is assigned with such duty and therefore they are not accounted towards RES use in Kosovo.

Furthermore, the current legislative framework does not foresee if and how such already installed generators can become prosumers.

## STATUS OF PV DEPLOYMENT IN KOSOVO

Kosovo’s RES policy and legislative framework has resulted with fulfillment of defined targets for photovoltaics (PV) energy. The PV targets are achieved via Support Mechanism based on Feed-in Tariffs, however, there is a growing trend in Behind-the-meter and Prosumer installations.



**Figure 13 Installed PV capacity in Kosovo during period 2013 – 2020**

The Support Scheme based on **Feed-in Tariff**, during period 2013-2019, resulted with total 42 applications, and out of these:

- 10 MW or six (6) applications were granted with Final Authorization and are in operation;
- 20 MW or eight (8) applications were granted with Preliminary Authorization; and
- 82.267 MW or 28 applications received Preliminary Authorization and are considered as “pending applications” or “the waiting list”.

The Support Scheme for **Self-consumption generators / Prosumer** (based on net-metering) has resulted with:

- 1,527.91 kW or 50 authorized projects that are in operation; and
- 67.2 kW or one (1) project in process of review.

The Support Scheme based on **Regulated Framework** (which includes RES reference price) has not been utilized by any developer to date.

Also, during period 2013 –2020, a considerable number of **Behind-the-meter** installations have been completed. Based on survey carried out during October-November 2020, there are at least 180 such installations, mainly on rooftops, including agricultural-processing facilities. This number does not account for all small-scale projects based on agricultural grants issued by MAFRD, since their IT system does not allow for data extraction. Based on the number of grants issued since 2014 that included RES measures, and information from installations firms, it can be assumed that there are about 1,000 installed projects with an average installed capacity between 3 and 5 kW per project.

## PROJECTS BASED ON AUTHORIZATION PROCESS AND FEED-IN TARIFF

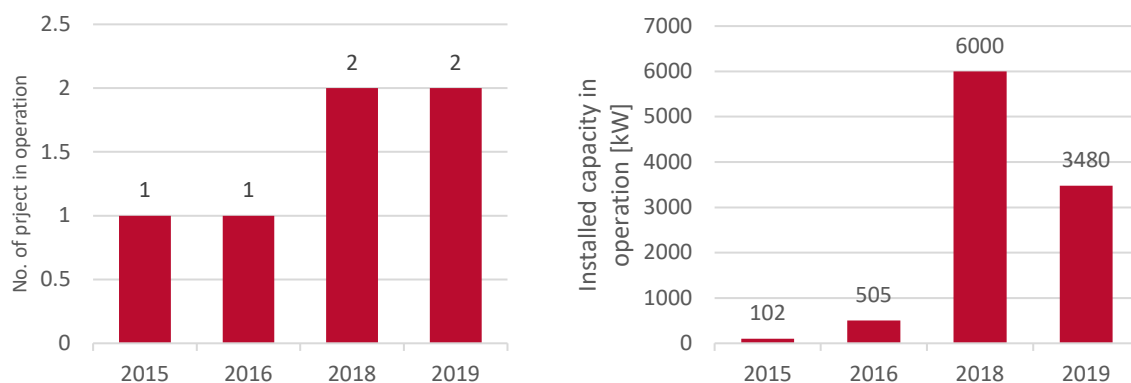
Since introduction of RES targets in 2013, the Authorization Rule, and Support Scheme based on Feed-in Tariffs in 2014, private sector has shown great interest to invest in RES projects in Kosovo. For solar photovoltaics projects based on FiT, to date, ERO has received 42 applications. Out of these:

- The first six (6) applications have fulfilled the initial target of 10 MW set by AI (MED) No. 01/2013 on Renewable Energy Source Targets, and ERO Decision No. V\_673\_2014 (23.12.2014) that determined FiT price for photovoltaic projects.
- The subsequent eight (8) applications have fulfilled the additional 20 MW as determined by AI (MED) No. 05/2017 on Renewable Energy Source Targets, and ERO Decision No. V\_1204\_2019 (27.11.2019). However, these projects have received only the Preliminary Authorization and issue of the Final Authorization is pending court decision on administrative process regards to ERO Decision No. V\_1204\_2019 and is currently suspended by the court as interim measure.
- The ERO received addition 28 application for new PV projects based on Support Scheme and listed them as “pending applications”, subject to release of available targets in line with the availability of Support Scheme targets, i.e., shall any of the applications that received the Preliminary Authorization not materialize e.g., fail to fulfill the conditions for Final Authorization or conditions for start of construction.

On June 5, 2019, the Board of ERO adopted Decision No. V\_1160\_2019 suspending admission of new applications for obtaining the authorization for construction of new generation capacities, to be handled as “pending applications”, and to be included in the Support Scheme, outside RES Targets set by Administrative Instruction no. 05/2017.

### FIT PV PROJECTS IN OPERATION

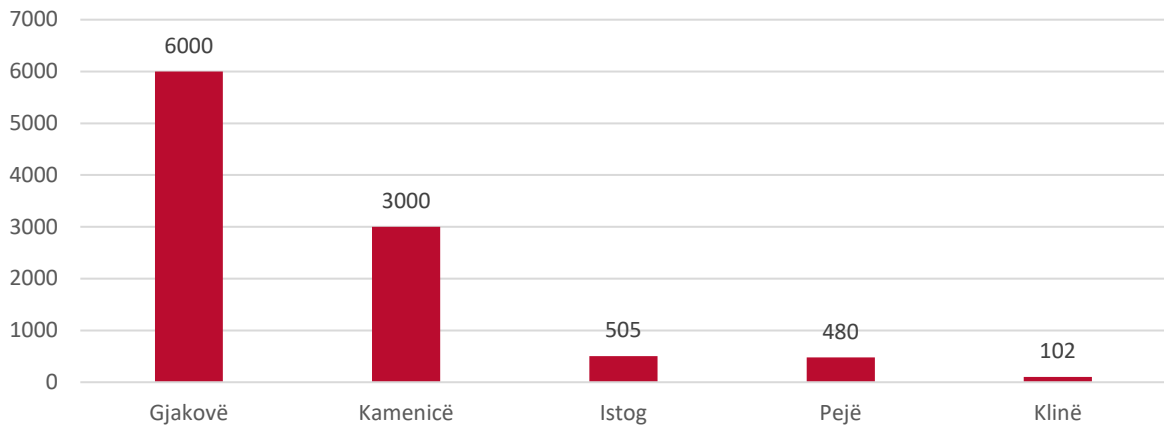
All initial six (6) projects that have received the Final Authorization have been constructed and are in operation.



**Figure 14 Number of installed FiT PV projects and capacity during period 2015 - 2019**



**Figure 15 Location of FIT PV projects in operation**



**Figure 16 Solar PV installations in operation based on FiT by municipality**

## LED Light Technology Kosova (0.102 MW)

The 102 kW project in Gjurgjevik, Klinë is the first project implemented in Kosovo supported by Feed-in Tariff, by a foreign investor. The project site has been granted with another Preliminary Authorization for additional 267 kW. The Final Authorization for this additional capacity is pending court decision on administrative process regards to ERO Decision No. V\_1204\_2019.



**Figure 17 Gjurgjevik, Klinë, 102 kW Solar PV based on Feed-in Tariffs**

### Project key facts:

- Location: Gjurgjevik, Klinë
- Coordinates: 42°37'16.41"N, 20°39'38.10"E
- Year of Operation: 2015
- Installed capacity: 102 kW
- Power output: ~157 MWh/year
- Solar panel parameters: Polycrystalline, Rack on ground, Fixed-tilt.
- Manufacturer of solar panels: Gorenje
- Country of origin of solar panels: Slovenia (EU)
- Developer: LED Light Technology Kosova Sh.p.k.
- Implemented by: RUDIS, Slovenia

## ONIX Spa (0.5 MW)

ONIX Spa is a natural hydrothermal spa resort, operating on well-known site used for its health benefits since 1930s. ONIX Spa operates hotels, pools, and physio-therapeutical rehabilitation center, operating year-round. As a cost saving measure the resort owner decided to implement energy efficiency and RES projects. The main project is the 0.5 MW solar PV based on Feed-in Tariff. The resort installed additional 224 kW (104 + 120 kW) in operation for self-consumption (Behind-the-meter) and plans to add 95 kW (75 + 20 kW) roof-top for self-consumption. Due to legislative restrictions the resort cannot benefit from the Prosumer scheme due to connection voltage limitations.



**Figure 18 ONIX Spa, Banja e Pejës, Istog, 500 kW Solar PV based on Feed-in Tariffs**

### Key fact:

- Location: Banja e Pejës, Istog
- Coordinates: 42°43'15.40"N, 20°23'8.66"E
- Year of Operation: 2016
- Installed capacity: 500 kW
- Power output: ~706 MWh/year
- Solar panel parameters: Polycrystalline, Rack on ground, Fixed-tilt.
- Manufacturer of solar panels: Canadian Solar, Shine solar group
- Country of origin of solar panels: China
- Developer: ONIX Spa SH.P.K.,
- Implemented by: Interimg SH.P.K.

## Birra Peja (3 MW)

The “Eco Park” project developed by Birra Peja Sh.A. is the first of the larger 3 MW project implemented in Kosovo supported by Feed-in Tariffs.

The investor, Birra Peja is the biggest brewery and beverage producer in Kosovo, known for Birra e Pejës beer, Multi Sola and Sola Ice Tea, and Go+ energy drink. The construction of the brewery in Peja started in 1968 while the production started in 1971. Following the privatization process in 2006, considerable investments have been made in new production, technology, energy, infrastructure, marketing, and other sectors.



**Figure 19 Eco Park, Madanaj- Kusar, Gjakovë, 3,000 kW Solar PV based on Feed-in Tariff**

### Key fact:

- Location: Madanaj - Rypaj, ZK Kusar, Gjakovë
- Coordinates: 42°24'14.55"N, 20°22'54.96"E
- Year of Operation: 2018
- Installed capacity: 3,000 kW
- Power output: ~4,000 MWh/year
- Solar panel parameters: Polycrystalline, Rack on ground, Fixed-tilt.
- Manufacturer of solar panels: Canadian Solar
- Country of origin of solar panels: China
- Developer: Birra Peja SH.A.
- Implemented by: Solea AG (Germany)

### Frigo Food Kosovë (3 MW)

Frigo Food Kosovë Sh.P.K. developed another 3 MW project supported by Feed-in Tariff located next to “Eco Park” project in Madanaj, Gjakovë.



**Figure 20 Frigo Food Kosovë, Madanaj-Kusar, Gjakovë, 3,000 kW Solar PV based on Feed-in Tariff**

#### Key fact:

- Location: Madanaj - Rypaj, ZK Kusar, Gjakovë
- Coordinates: 42°24'22.31"N, 20°22'48.74"E
- Year of Operation: 2018
- Installed capacity: 3,000 kW
- Power output: ~4,000 MWh/year
- Solar panel parameters: Polycrystalline, Rack on ground, Fixed-tilt
- Manufacturer of solar panels: Canadian Solar
- Country of origin of solar panels: China
- Developer: Frigo Food Kosovë SH.P.K.
- Implemented by: Solea AG (Germany)



## Eling (0.48 MW)

Eling 0.48 MW in Llabjan, Peja is another project implemented in Kosovo supported by Feed-in Tariff. The developer N.T.S.H. Eling operates in the field of energy, specializing in electrical installations, electrical measurements, and sales of electrical material in Kosovo. The project site has been granted with another Preliminary Authorization for additional 3 MW listed as “pending applications”, subject to release of available targets in line with the availability of Support Scheme targets.



**Figure 21 Eling, Llabjan, Pejë, 480 kW Solar PV based on Feed-in Tariffs**

### Key fact:

- Location: Llabjan, Pejë
- Coordinates: 42°39'26.78"N, 20°25'25.58"E
- Year of Operation: 2019
- Installed capacity: 480 kW
- Power output: ~615 MWh/year
- Solar panel parameters: Polycrystalline, Rack on ground, Single-axis tracker with manual operation
- Country of origin of solar panels: China
- Developer: N.T.S.H. Eling, Kosovo
- Implemented by: Elen SH.P.K., Kosovo.

## Solar Green Energy (3 MW)

Solar Green Energy in Novosellë, Kamenicë is the last project in operation being implemented under the Feed-in Tariff by local private investors.



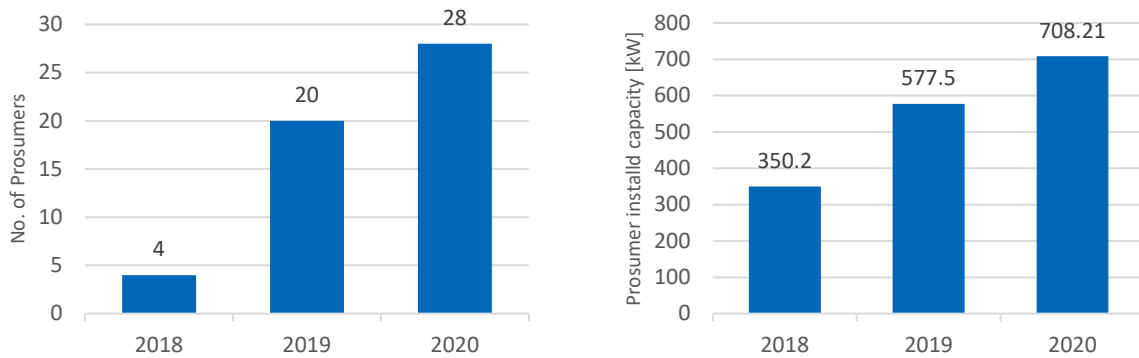
**Figure 22 Solar Green Energy, Novosellë, Kamenicë , 3,000 kW Solar PV based on Feed-in Tariffs**

### Key fact:

- Location: Novosellë, Kamenicë
- Coordinates: 42°33'12.88"N, 21°42'8.61"E
- Year of Operation: 2019
- Installed capacity: 3,000 kW
- Power output: ~4,000 MWh/year
- Solar panel parameters: Polycrystalline, Rack on ground, Fixed-tilt
- Manufacturer of solar panels: Jaha Solar
- Country of origin of solar panels: Kosovo
- Developer: Solar Green Energy SH.P.K.
- Implemented by: Jaha Solar SH.P.K., Kosovo

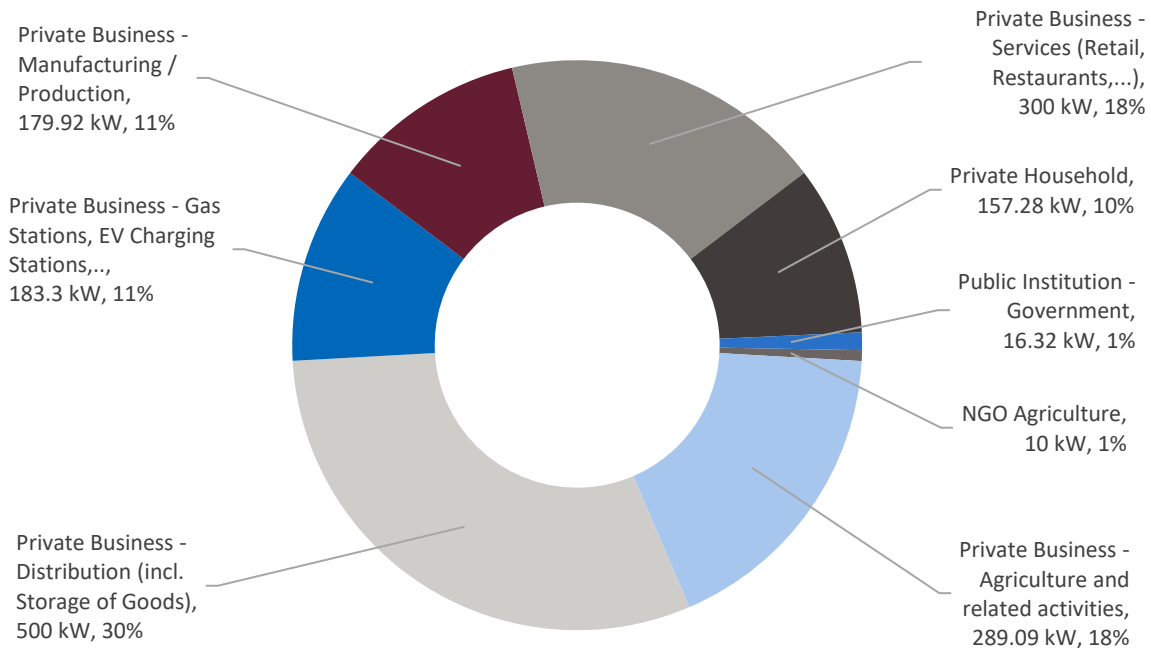
## PROSUMERS (SELF-CONSUMPTION GENERATORS) INSTALLATIONS

Since introduction of ERO Rule on Support Scheme No. 10/2017, customers with electricity supply contract are allowed to enter into a Prosumer Agreement with their supplier based on net-metering arrangement. To date, this Support Scheme has been utilized by 50 customers, and a total installed capacity of 1,527.91 kW was authorized by ERO. Moreover, one project of 67.2 kW is in review process by ERO and other projects are in development.



**Figure 23 Number and capacity of Prosumer installations 2018 - 2020**

As presented in Figure 23 and Figure 25, the majority of Prosumer projects are located in industrial zones of municipalities of Ferizaj, Graçanicë, Pejë and Prishtina, that correlates with concentration of manufacturing, processing and service facilities, businesses that see the Prosumer Support Scheme as main cost saving measure, in contrary to households that represent only 10% of Prosumer installed capacity.



**Figure 24 Allocation of main types of activity by existing Prosumers**

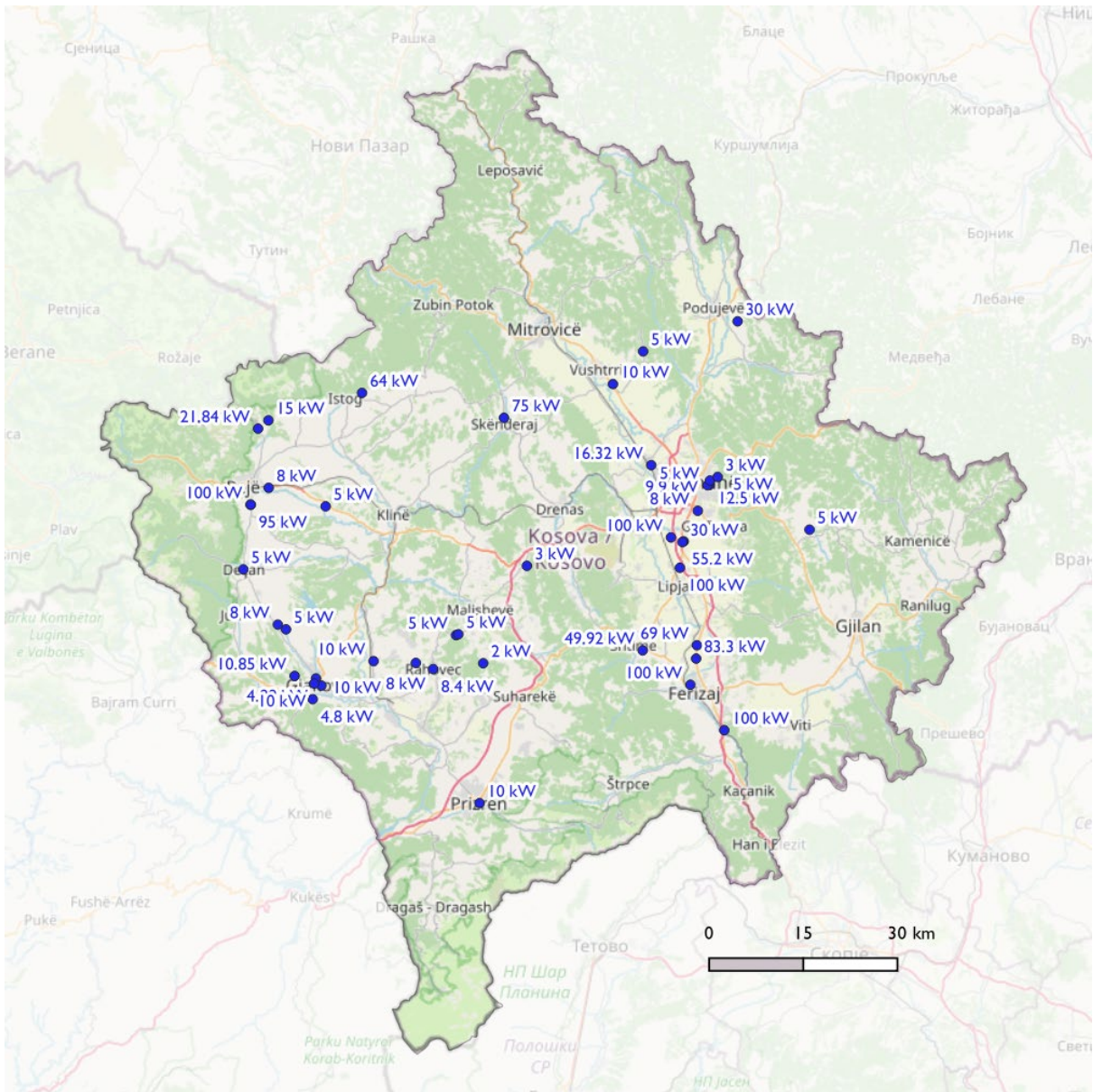


Figure 25 Location of Prosumer projects in operation

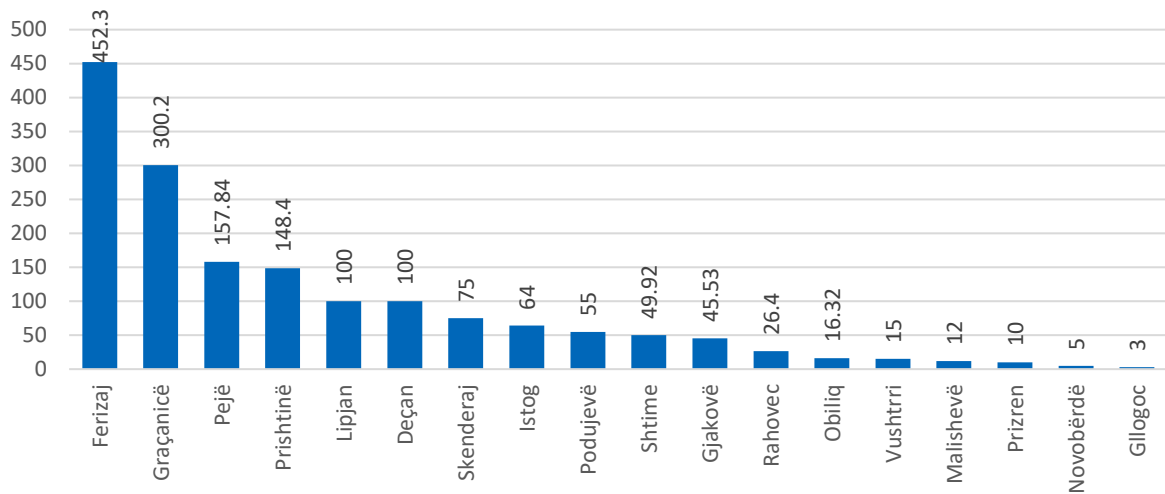
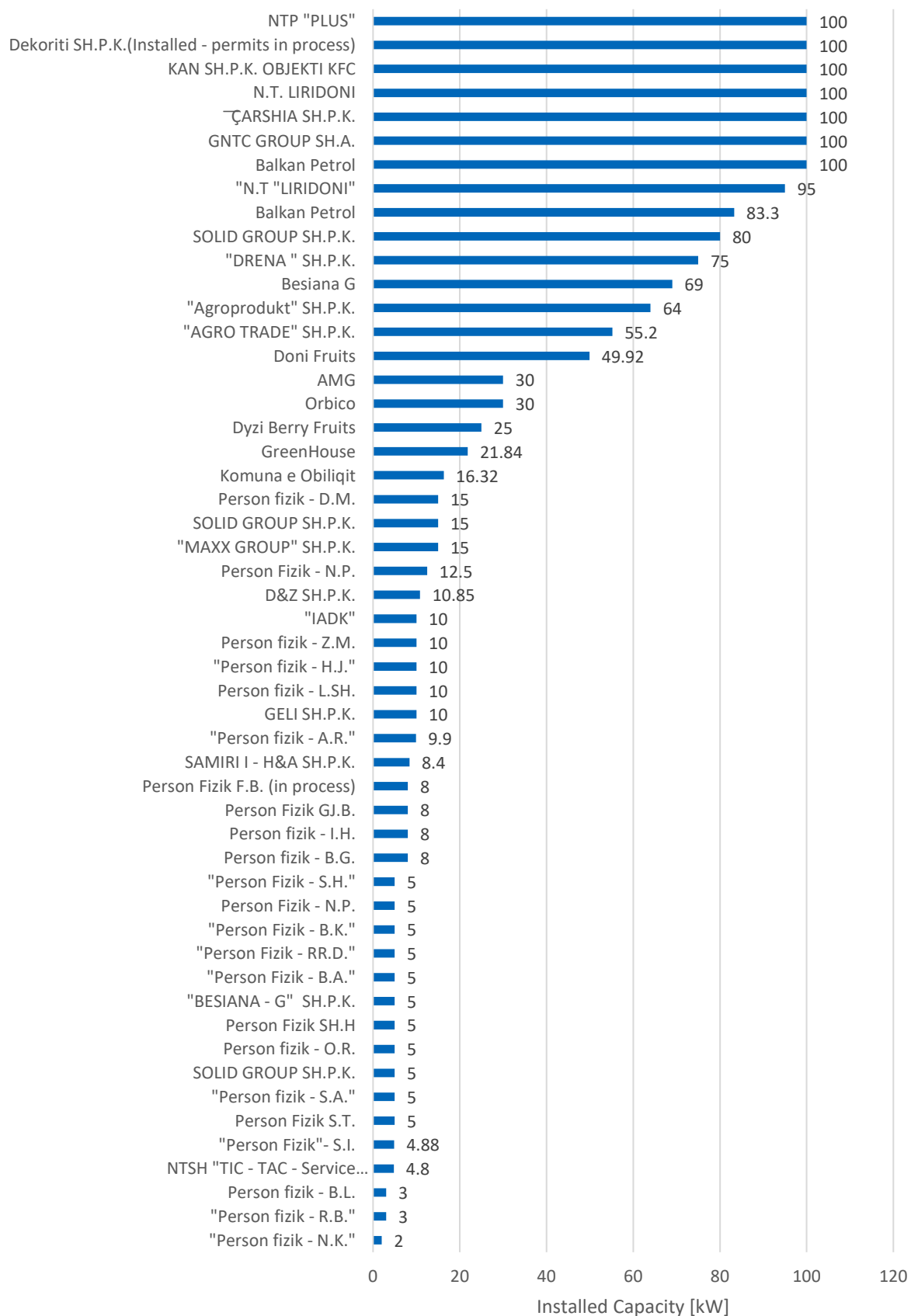


Figure 26 Installed Prosumer capacity by municipality



**Figure 27 List of Authorized Prosumers and their installed capacity**

## BEHIND THE METER INSTALLATIONS

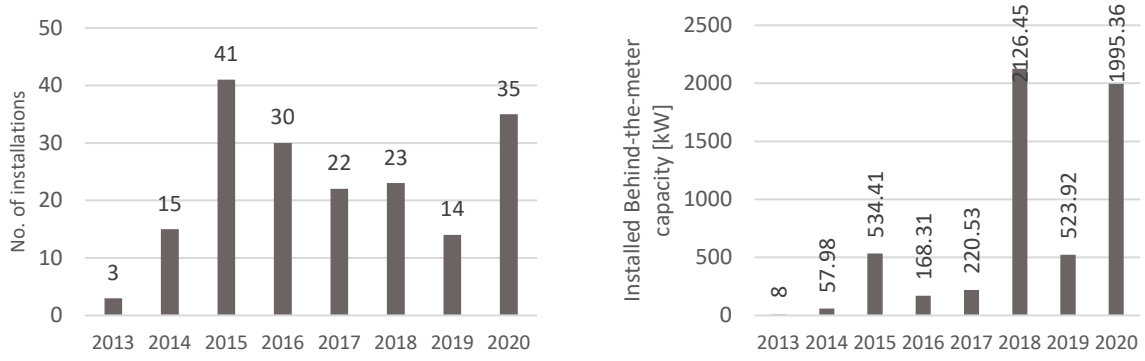
With technological advancement, decreasing of cost of PV technology, coupled with introduction of RES policy, mandatory targets, and legislative framework, the private sector responded positively by initially establishing solar PV installation companies that resulted with creation of completely new market segment.

Since 2013, this sector continued to grow despite many challenges it faced as new industry. The real boost to the sector came in 2014 when Ministry of Agriculture introduced RES measures within the agricultural grant scheme. Based on the number of grants issued since 2014, and information from installations firms, it can be assumed that there are about 1,073 installed off-grid projects in the agricultural sector, with total installed capacity of 3,690 kW. The average installed capacity of solar PV for agricultural grants is between 1 and 5 kW per project and between 6-12 kW for agro-processing facilities. This had numerous effects, with immediate being capacity building of installation firms' experience and their establishment in the market, job creation, and ultimately increase of installed solar PV capacity. Behind-the-meter solar PV installations pioneered solar energy in Kosovo.

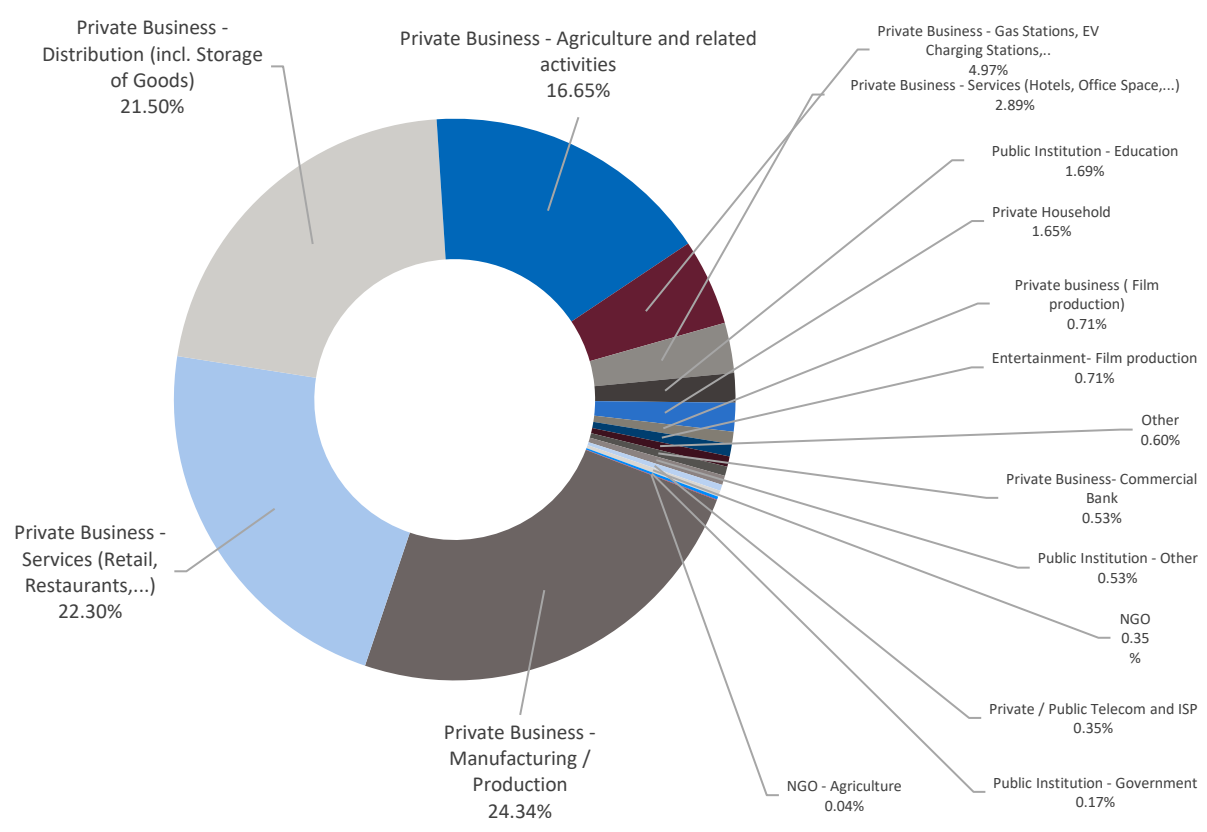


**Figure 28 Off-grid solar PV installations: (left) Zajqevc apple tree plantation, and Frutomania processing facility (right)**

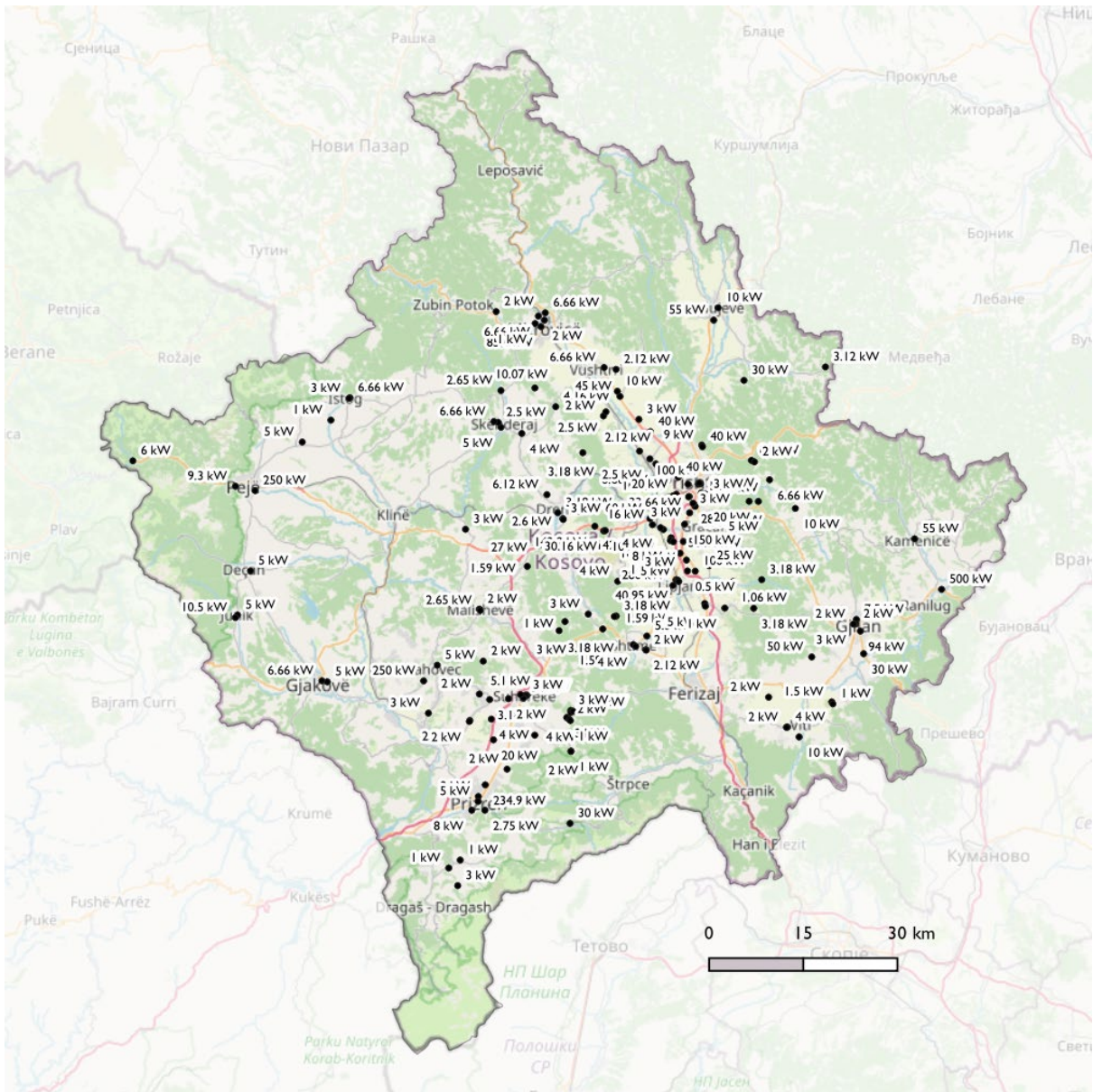
The confidence of private sector in solar PV increased gradually with number of installations, which at the same time acted as a marketing tool resulting with even more new installations reaching out to sectors beyond agricultural grants. The survey carried out during October-November 2020, registered around 180 such installations, as presented in Figure 28 , mainly on rooftops, also including new private business segment as shown in Figure 29.



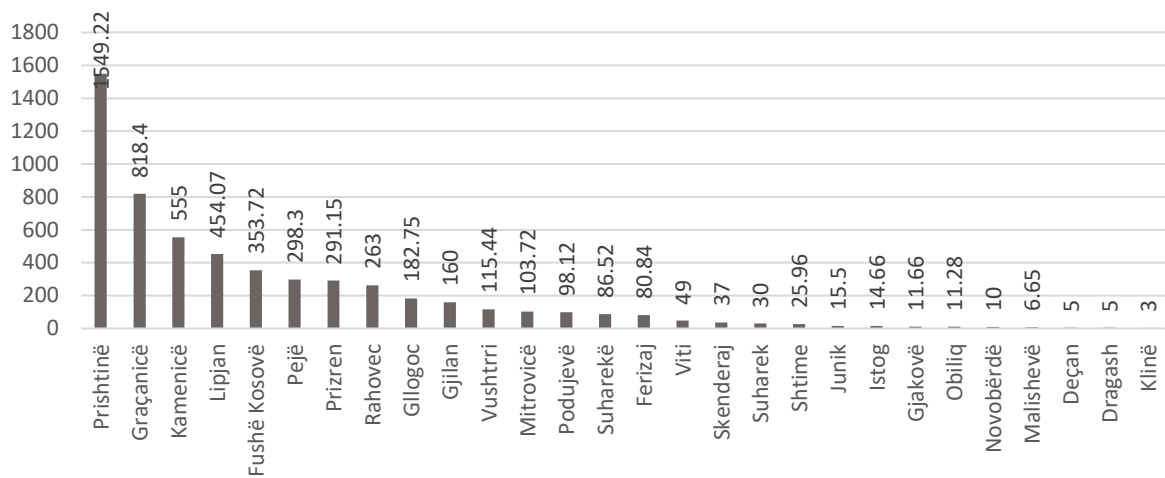
**Figure 29 Number and capacity of Behind-the-meter installations 2013 - 2020**



**Figure 30 Share of installed capacity of Behind-the-meter by sector**



**Figure 31 Location of Behind-the-meter projects in operation**



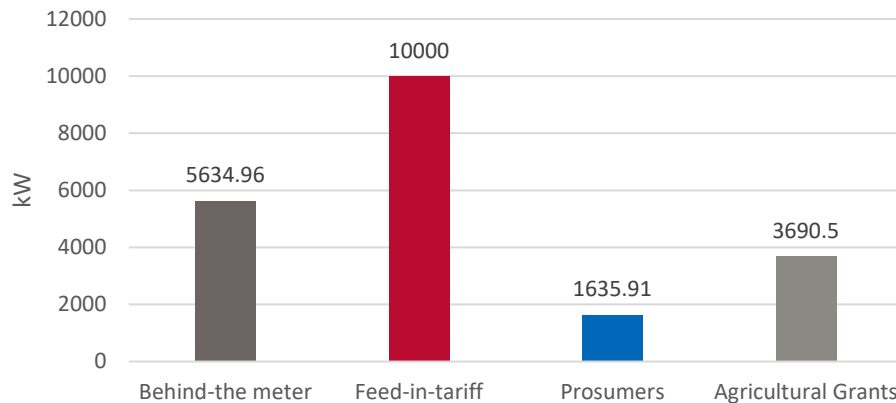
**Figure 32 Installed Behind-the-meter capacity by municipality**



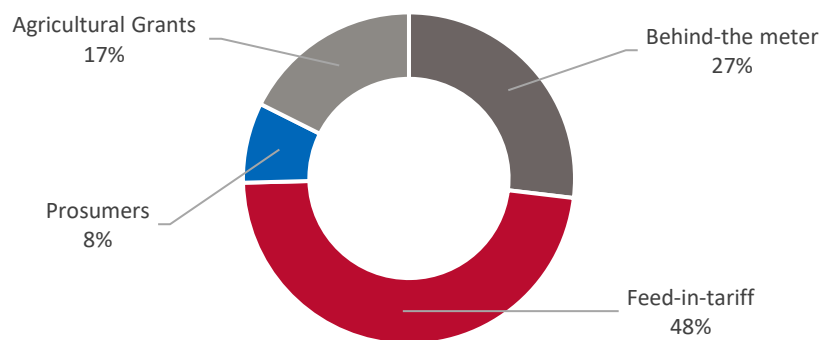
## SOLAR PV TRENDS IN KOSOVO 2013 – 2020

Figures presented below summarize status of solar PV deployment in Kosovo and various trends.

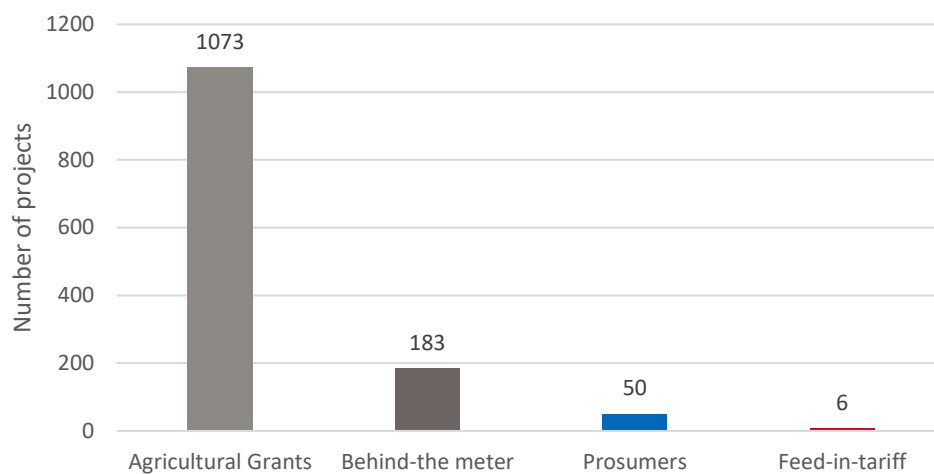
### MARKET SHARE BASED ON PROJECT TYPES



**Figure 33 Kosovo solar PV market share based on type of projects / installed capacity**

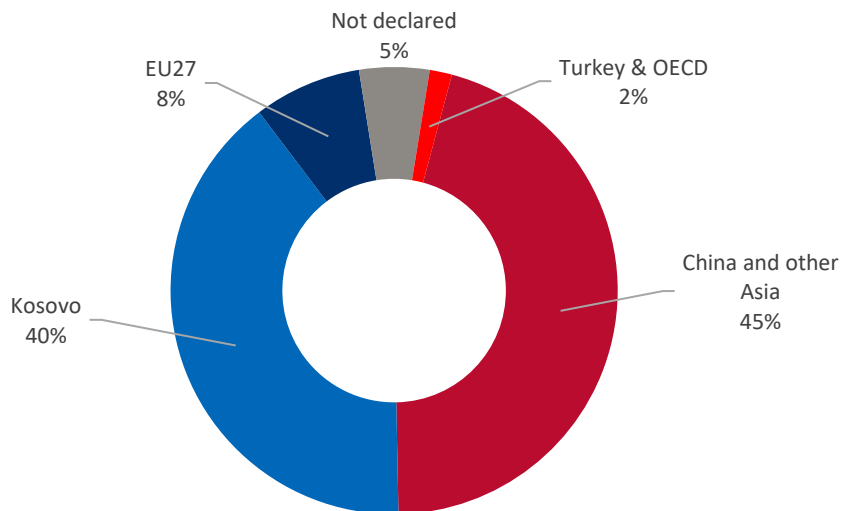


**Figure 34 Kosovo solar PV market share based on type of projects / installed capacity**

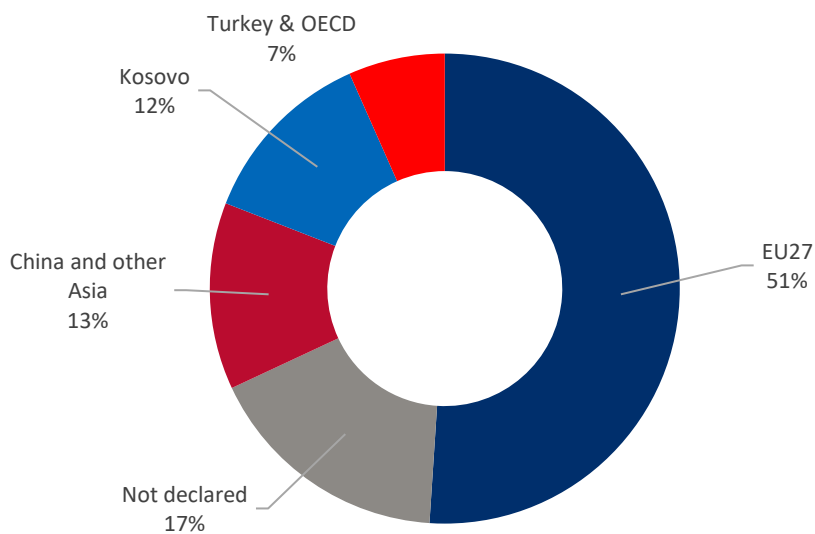


**Figure 35 Kosovo solar PV market share based on type and number of projects**

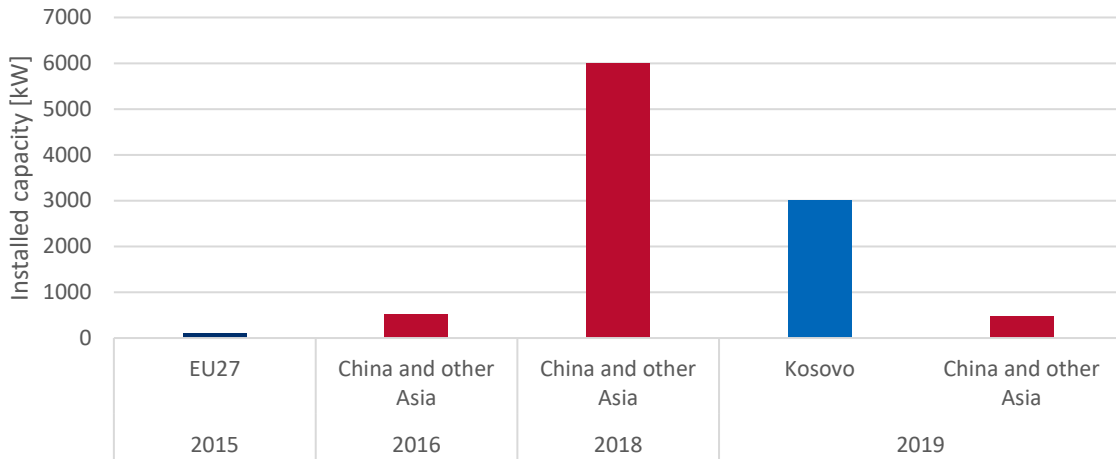
## MARKET SHARE BASED ON SOLAR PANELS COUNTRY OF ORIGIN



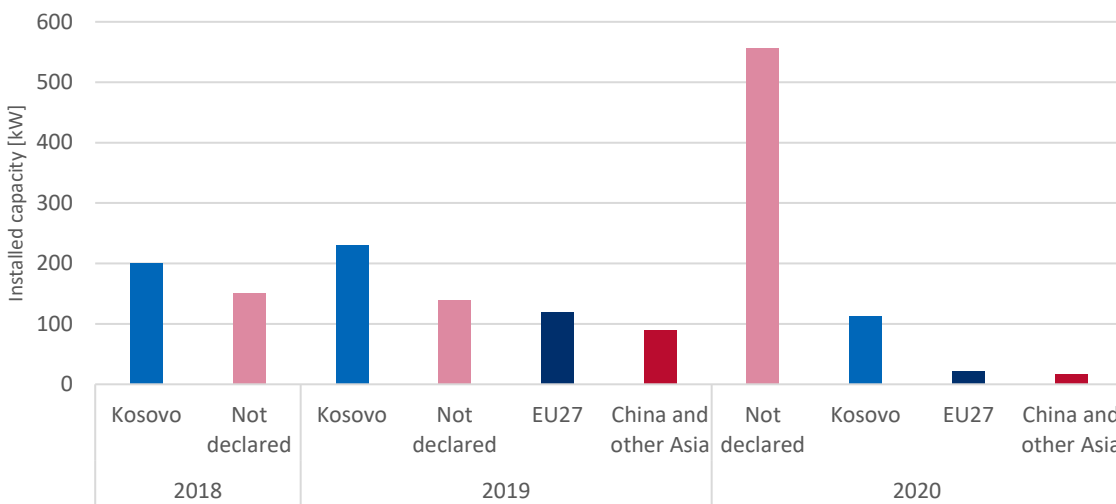
**Figure 36 Market share based on origin of solar panels per installed capacity**



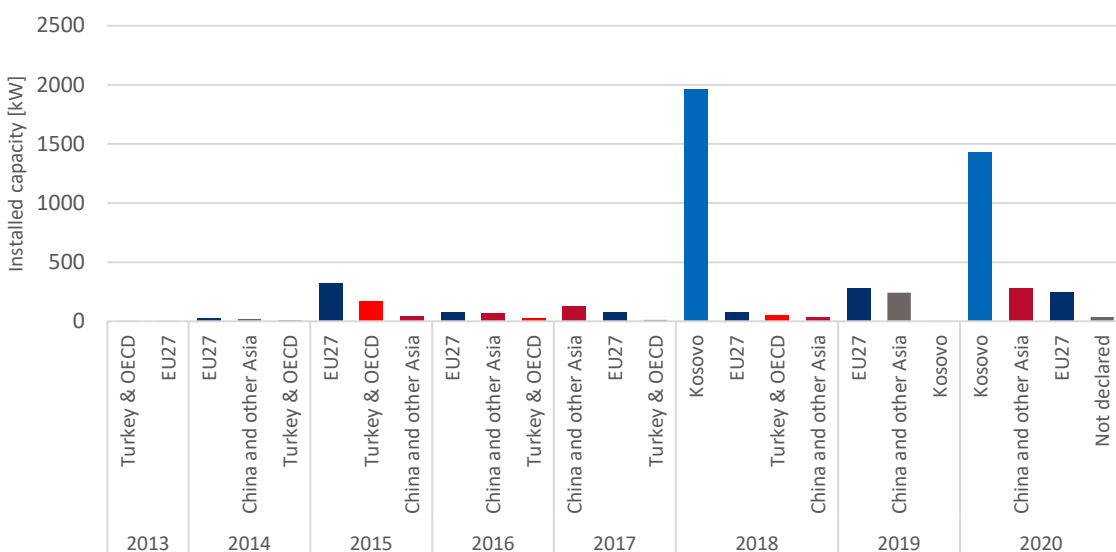
**Figure 37 Market share based on origin of solar panels per number of projects**



**Figure 38 Market share based on origin of solar panels for FiT PV projects**

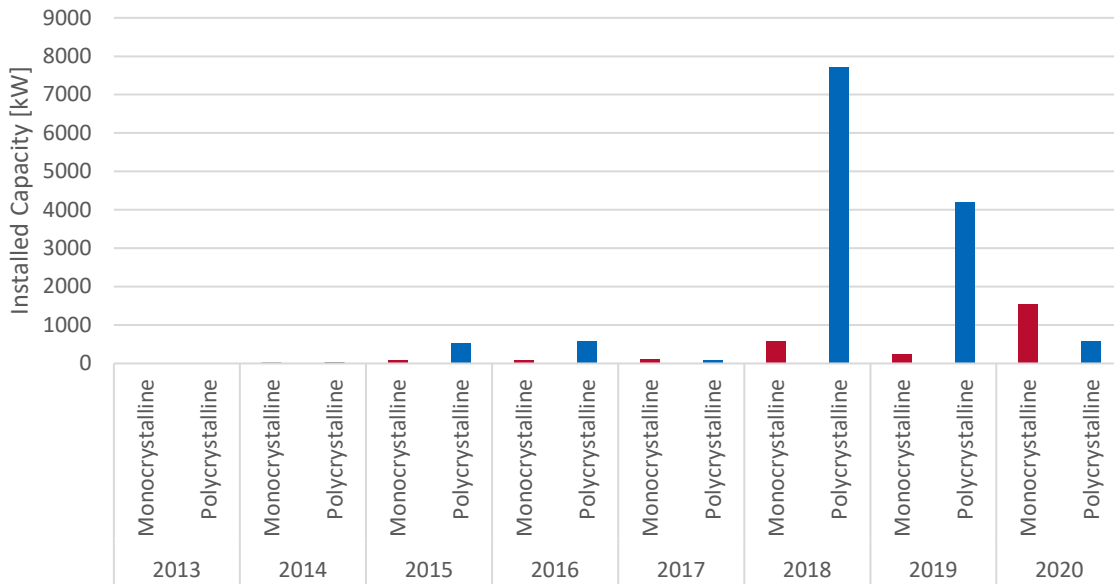


**Figure 39 Market share based on origin of solar panels per installed capacity of Prosumer projects**

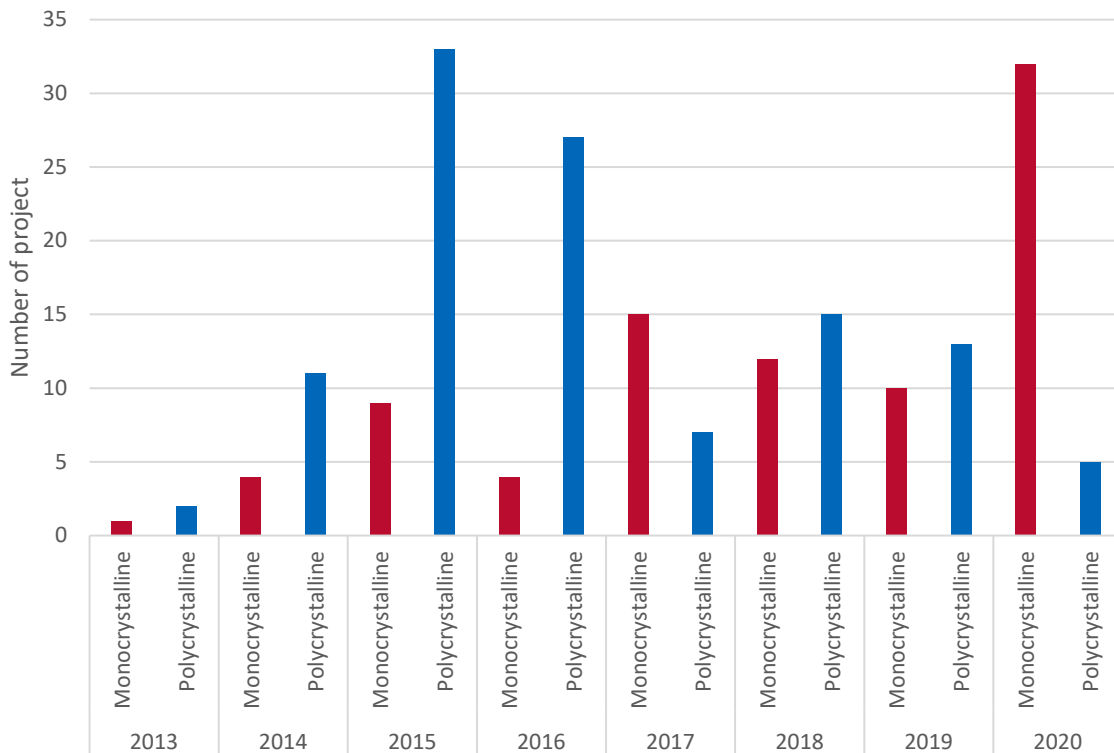


**Figure 40 Market share based on origin of solar panels per installed capacity of Behind-the-meter projects**

## TRENDS OF SOLAR PV PROJCT BASED ON SOLAR CELL TYPE

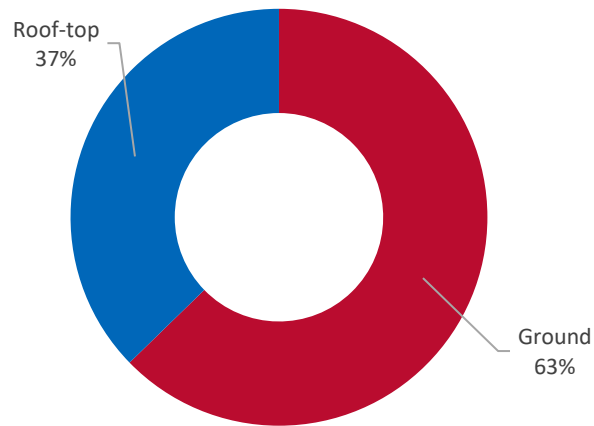


**Figure 41** Trend of solar cell types thought years / per installed capacity

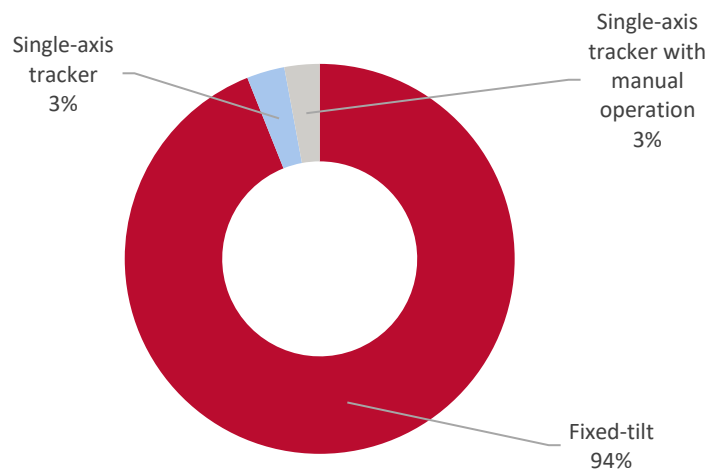


**Figure 42** Trend of solar cell types thought years / per installed projects

## SOLAR PV PROJECTS BY INSTALLATION



**Figure 43 Solar PV projects by type of rack installation**



**Figure 44 Solar PV projects by type of racks**

## PV SECTOR PERCEPTIONS AND EXPERIENCES

Renewable energy and solar PV in particular is considered as a very young sector in Kosovo. With first small-scale, off-grid commercial PV projects installed in 2013, followed with gradual introduction of legal and regulatory framework and incentives, the solar PV sector grew modestly, resulting with over 1,300 solar PV projects (or 20 MW total installed capacity), implemented by a dozen of newly established local private sector installation firms.

Founding of a solar PV panel assembly plant in Kosovo (first in the Balkans), and full implementation of 10 MW target for solar PV are considered as highlights of this period.

This immature but rapidly developing market was faced with many challenges, including lack of investor confidence in new technology, slow return on investment due to high technology prices but also low electricity prices, modest incentives or support schemes, absence of clearly defined administrative procedures for authorization, permitting and grid integration, lack of skilled labor but most importantly lack of public awareness on reliability and benefits of solar PV technology.

Building on top of their experiences, the solar PV sector is slowly organizing itself in associations, formulating their concerns, and raising their voice in effort to eliminate barriers, simplifying procedures, and proposing new incentive measures to make solar PV more attractive to private investors.

Below is a list of major concern raised by the solar PV sector:

- Limitation imposed on solar PV installed capacity for business prosumers;
- Limitations imposed on voltage level connection for business prosumers;
- Complex, timely and costly procedures for obtaining status of prosumer, mostly impacting return on investment for small household solar PV projects;
- Unclear requirements and lack of uniformity for obtaining Municipal permit for rooftop solar;
- Unnecessary requirement to have ERO Board approve Prosumer applications;
- Long list of documentation evidence required for obtaining project approvals with DSO;
- Unnecessary technical requirements imposed by DSO such as installation of additional electrical protection equipment, restriction on equipment manufacturers or requirement for additional certification;
- Lack of ERO approved methodology for connection to the DSO grid resulting with increased cost for larger solar PV projects due to deep connection requirement or determination of connection point further away from the project site;
- Transfer of ownership to DSO, such as transformers, without compensation;
- Imposition by DSO for installation firm to carry out grid assessment studies outside of project site to the connection point; etc.

The solar PV sector greatest concern is related to complexity and uncertainty in procedures resulting with delays making these investments unattractive to household and private business investors. In majority of cases the installation firms offer to investors turnkey solution, including handling of administrative procedures, and often are faced with hurdles or delays that risk their reputation. A very simple example is lack of ERO Board quorum meaning that no Prosumer project will be Authorized for some time. This is a missed opportunity for installation firms and for uncertain period of time.

In addition to above listed concerns, the solar PV sector also proposed measures to improve feasibility of solar PV installations such as eliminating VAT on small household projects, making these projects more attractive by shortening payback period for approximately 2 years.

Recommendations for overcoming these barriers are presented in Annex 3 report of Job Order KESS-027.

**U.S. Agency for International Development**  
**[www.usaid.gov](http://www.usaid.gov)**





# KOSOVO ENERGY SECURITY OF SUPPLY

## JO 27: ASSESSMENT OF PV GENERATORS IN KOSOVO

### ANNEX 2 – SOLAR PV OUTLOOK FOR KOSOVO 2030

January 2020

This publication was produced for review by the United States Agency for International Development. It was prepared by DT Global.

# KOSOVO ENERGY SECURITY OF SUPPLY (KESS)

## JOB ORDER KESS – 027 ASSESSMENT OF PV GENERATORS IN KOSOVO

### ANNEX 2 – SOLAR PV OUTLOOK FOR KOSOVO 2030

**Contract No:**

AID-167-C-17-00004

**Submitted to:**

USAID Kosovo

**Prepared by:**

DT Global

**Photo Caption:**

Solar PV park in Kamenica. Photo credits: KESS

**DISCLAIMER:**

The authors' views expressed in this document do not necessarily reflect the views of the United States Agency for International Development or the United States Government.

# CONTENTS

<b>Abbreviations</b> .....	<b>vi</b>
<b>Introduction</b> .....	<b>1</b>
<b>Solar PV projects pipeline</b> .....	<b>2</b>
Category 1. Projects based on Support Scheme with Feed-in Tariffs .....	2
Category 2. Projects for Self-consumption (Prosumers and Behind-the meter installations) ..	3
Prosumer Households.....	4
Prosumer Public Institutions .....	4
Private BusinessES .....	4
Category 3. Agricultural grants and subventions .....	5
Category 4. Large utility-scale projects.....	5
Category 5. Private sector initiatives.....	6
<b>Financing Solar PV in Kosovo</b> .....	<b>7</b>
Country Investment Risk Profile.....	7
Local Capital markets and Banks .....	8
Prospects for Investments in the Large Renewable Energy Projects.....	9
DFI Investment in large RE Projects in Kosovo .....	10
Financing Large-Scale Solar PV Projects in Kosovo – An Example.....	11
Example of a 50 MW Solar PV Project.....	11
Project Financing Options for A 50 MW Solar PV Project.....	15
Project Risks and Guarantees.....	19
Suggested Project Structure for the 50 MW Solar PV Project .....	21
Financing Other Solar PV in Kosovo .....	21
Behind-the meter / Off-grid installation .....	22
Prosumer installation (Self-consuming generators under Support Scheme based on Net-metering).....	28
Authorization Procedure (Support Scheme based on Feed-in Tariff and Regulated Framework).....	29
<b>Kosovo Electricity Demand Forecast 2030</b> .....	<b>33</b>
Energy Strategy (2017-2026).....	33
Scenarios forecasting electricity demand.....	34
Long Term Energy Balance (2019 – 2028) .....	36
<b>Kosovo RES targets 2030</b> .....	<b>37</b>
Draft National Energy & Climate Plan (NECP) of Kosovo.....	38
PV generation share in achieving 2030 targets .....	38
<b>Grid Integration &amp; Energy Market</b> .....	<b>39</b>
Grid Integration .....	39
RES integration to the Transmission Network.....	41
RES Integration to Distribution Network (KEDS) .....	42

Energy Market .....	44
Electricity Market Coupling Albania - Kosovo .....	47
<b>Gender inclusion, Education and Job opportunities in RES/ PV Solar sector in Kosovo.49</b>	
Employment opportunities.....	49
Education opportunities in RES and PV Solar .....	51
Center for Energy and Sustainability (QEQ).....	53
Rochester Institute for Technology RIT/A.U.K.....	54
KEK Training Center .....	54
KEDS Academy .....	56
Gender in energy sector RES/PV Solar .....	57
Recommendations .....	58
<b>Appendix I. Utility Scale Battery Storage Systems .....</b>	<b>60</b>

## FIGURES

Figure 1: Possible pipeline of future solar PV projects in Kosovo.....	2
Figure 2: Structure of a 50 MW Solar PV Project.....	12
Figure 3: Coverage Provided by Guarantees.....	20
Figure 4: Liquidity/Payment Guarantee for the 50 MW Solar PV Project.....	21
Figure 5: Schematic of a Typical Behind-the-Meter Installation.....	24
Figure 6: Schematic of a Typical Prosumer Installation.....	28
Figure 7: Schematic of a Typical Project under the Authorization Scheme.....	31
Figure 8: Energy Demand Forecast 2020 - 2030.....	33
Figure 9: Electricity Demand Scenarios.....	35
Figure 10: Scenario of Low, Medium (base) and High Growth of Gross Electricity Demand.....	36
Figure 11: Solar PV Project Pipeline Scenarios in Meeting Gross Electricity Demand.....	39
Figure 12: Interconnection capacities of European countries.....	40
Figure 13: Physical and Commercial Transfers in the Current Market Structure.....	46
Figure 14: Electricity Prices for Household Consumers, Second Half 2019 (Source: Eurostat).....	46
Figure 15: Universal Service Supply Retail price (€/MWh) Under Different Convergence Scenarios, Very High Growth.....	47
Figure 16: Electricity Wholesale Prices in SM and CM in Kosovo and Albania.....	48

## TABLES

Table 1: Summary of Inputs to Financial Model for Large-Scale Solar PV Projects.....	13
Table 2: Typical Provisions in a Term Sheet.....	18
Table 3: Project Risks.....	19
Table 4: Case 4 – A private business with 3,000 kW capacity installation.....	31
Table 5: Projections of Economic Growth According to the Document: Economic Reform Program.....	34
Table 6: Summary of Scenarios of Electricity Demand of Electric System.....	34
Table 7: Demand for Electricity Based on Scenario 2 of Electricity Final Consumption.....	35
Table 8: Demand for Gross Electricity Based on Scenario 2 of Electricity Consumption.....	35
Table 9: Numerical Data of the Scenarios of the Gross National Demand for Electricity.....	37
Table 10: Development of Installed Interconnection Capacity and System Peak Load in High Scenario.....	40
Table 11: Development of Installed Interconnection Capacity and RES Projects Development.....	41
Table 12: Applications for RES projects in KOSTT.....	41
Table 13: List of Accredited Study Programs that Include RES and Solar Modules/Topics.....	52

## ABBREVIATIONS

AI	Administrative Instruction
CEFTA	Central European Free Trade Agreement
CEP	Clean Energy for all Europeans Package
CP	Contracting Party of the Energy Community Treaty
DSO	Distribution System Operator
DFI	Development Finance Institutions
EC	European Council
EnC	Energy Community
EnCT	Energy Community Treaty
ERO	Energy Regulatory Office
EU	European Union
EPC	Engineering-Procurement-Construction
FiT	Feed-in Tariff
GoK	Government of Kosovo
KEDS	Kosovo Energy Distribution Services
KESCO	Kosovo Company for Supply of Energy
KESS	Kosovo Energy Security of Supply (A USAID project implemented by DT Global)
KIESA	Kosovo Investments and Enterprise Support Agency
KOSTT	Transmission, System and Market Operator of the Republic of Kosovo
Ktoe	Kiloton of oil equivalent
kW	Kilowatts (capacity)
kWh	Kilowatthours (energy)
MAFRD	Ministry of Agriculture, Forestry and Rural Development
MED	Ministry of Economic Development (now part of MEE)
MEE	Ministry of Economy and Environment
MESP	Ministry of Environment and Spatial Planning (now part of MEE)
MF	Ministry of Finance
IPA	Instrument for Pre-Accession Assistance
MO	Market Operator, electricity
MTI	Ministry of Trade and Industry
NECP	National Energy and Climate Plan(s)
NREAP	National Renewable Energy Action Plan
PPA	Power Purchase Agreement
PPP	Public Private Partnership
PV	Photovoltaics
RES	Renewable Energy Source(s)
TSO	Transmission System Operator
USAID	United States Agency for International Development
VAT	Value Added Tax

## INTRODUCTION

This Annex 2 is second out of three Annex reports that are integral components of the Summary Report for of KESS Job Order No. 027 - Assessment of Photovoltaic (PV) generators in Kosovo.

The main purpose of this Annex 2 report is to present a pipeline of potential new solar PV projects that can be developed in Kosovo within next 10 years.

This Annex 2 report is organized in following sections:

- **Section 1 – Solar PV Projects Pipeline:** Summarizes and describes the pipeline of potential new solar PV projects based on different project categories, procedures, and their implementation likelihood
- **Section 2 – Financing Solar PV in Kosovo:** Describes the overall renewable energy financing climate, investment risk profile, prospects for investments, Development Finance Institutions (DFI) involvement, and provides examples of financing structures for large scale and other solar PV projects in Kosovo.
- **Section 3 – Kosovo Electricity Demand Forecast 2030:** Builds on top of existing electricity demand scenarios and extrapolates electricity demand to 2030.
- **Section 4 – Kosovo RES Targets 2030:** Describes Kosovo’s mandatory and voluntary renewable energy source (RES) targets for 2020, achievements, expected new Kosovo 2030 targets, envisaged solar PV installed capacity according to the National Energy and Climate Plan (NECP), and describes the new solar PV project pipeline’s share in meeting gross electricity demand in 2030.
- **Section 5 - Grid Integration & Energy Market:** Describes status of the distribution and transmission grid allowing new RE project integration and describes electricity market operation in the coupled Kosovo/Albania electricity market.
- **Section 6 - Gender inclusion, Education and Job opportunities in RES/PV Solar sector in Kosovo:** This section provides information on current job market and potential employment opportunities in the solar PV sector of Kosovo. It also outlines information on gender inclusion and education opportunities to meet market needs with respect to human capital, while providing a set of recommendations to the government on improving curricula, developing training programs and improving gender balance in the sector.

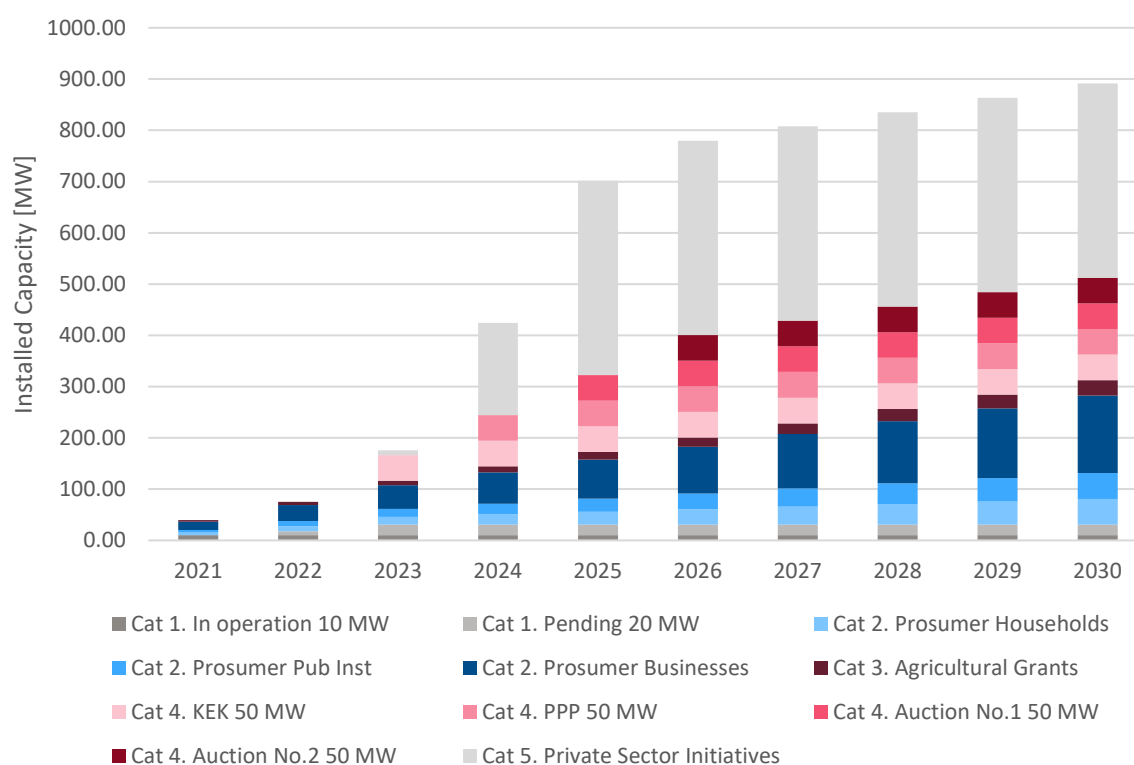
This Annex 2 report builds on top of the Annex 1 report – Current status of solar PV deployment in Kosovo and is followed by an Annex 3 report – Barriers and Recommendations.

## SOLAR PV PROJECTS PIPELINE

The potential pipeline of future solar PV projects in Kosovo as summarized in Figure I below is the result of data collected through interviews with government institutions, the regulator, public and private sector companies, international development agencies, and an analysis of existing and draft national energy plans.

The future solar PV projects summarized in Figure I have been categorized as follows:

- Category 1. Projects based on Support Scheme with Feed-in Tariffs.
- Category 2. Projects for self-consumption (prosumers and behind-the meter installations).
- Category 3. Agricultural grants and subventions.
- Category 4. Large utility-scale projects (tendering, auctions).
- Category 5. Private sector initiatives.



**Figure I: Possible pipeline of future solar PV projects in Kosovo**

The assumptions used for the solar PV project pipeline are described in the sections below.

Subsequent detailed surveys and analysis will more finely detail the potential and likely timeline for each market segment.

### CATEGORY I. PROJECTS BASED ON SUPPORT SCHEME WITH FEED-IN TARIFFS

Since the introduction of RES targets in 2013, the Authorization Rule, and the Support Scheme based on Feed-in Tariffs (FiT) in 2014, the private sector has shown great interest to invest in RES projects in Kosovo. For solar PV projects based on FiTs, the Energy Regulatory Office (ERO) has received 42 applications, and their current status is as follows:



- **Projects in Operation:** The first six applications fulfilled the initial quota target of 10 MW set by AI (MED) No. 01/2013 on Renewable Energy Source Targets, and ERO Decision No. V\_673\_2014 (23.12.2014) that determined the FiT price for solar PV projects.
- **Additional 20 MW List:** The subsequent eight applications fulfilled the additional 20 MW quota as determined by AI (MED) No. 05/2017 on Renewable Energy Source Targets, and ERO Decision No. V\_1204\_2019 (27.11.2019). However, these projects have received only the Preliminary Authorization and Final Authorization is pending a court decision on the administrative process with regard to ERO Decision No. V\_1204\_2019, and Authorization is currently suspended by the court as an interim measure. Additionally, the Commission for State Aid issued Decision No.17/2020 that determined that support by FiT is considered as forbidden state aid and not authorized, based on Article 14 (1.3) of the Law on State Aid. These projects are on hold pending these issues.
- **Waiting List:** The ERO has received an additional 28 applications for new solar PV projects based on the Support Scheme and has listed them as “pending applications.” These projects might be considered based on the release of quotas from the above 20 MW quota or if additional quota under the Support Scheme is authorized. However, they would still have to overcome the objection under the Law on State Aid.

On June 5, 2019, the Board of the ERO adopted Decision No. V\_1160\_2019 that new applications for Authorization for construction of new generation capacities will be designated as “pending applications”, and be included in the new Support Scheme, outside the RES Targets set by Administrative Instruction No. 05/2017.

On December 10, 2020, the Board of the ERO adopted Decision No. V\_1321\_2020 to stop receipt of new applications for projects based on FiT, including the cancelation of Wait Listed applications (projects beyond set RES targets).

As a result of the recent decision, only applications that have received Preliminary Authorization for 20 MW supported by FiT have been considered as future potential projects. The implementation of these projects is subject to the outcome of ongoing court proceedings and overcoming the objection under State Aid.

## **CATEGORY 2. PROJECTS FOR SELF-CONSUMPTION (PROSUMERS AND BEHIND-THE METER INSTALLATIONS)**

In 2017, the Rule on Support Scheme introduced support for RES based projects for self-consuming generators that could utilize net metering (Prosumers). Over the past three years this scheme was utilized by more than 50 small projects totaling with 1.8 MW of installed capacity. The current support scheme has limitations preventing more rapid development of the prosumer projects. Elimination of these barriers in accordance with the Energy Community Policy Guidelines for Prosumers, will unlock this very promising segment of solar PV. Recommendations for overcoming those barriers are mentioned below and described in more detail in the Annex 3 report.

The other type of self-consuming generators known as behind-the meter and off-grid installations, including installations that do not feed surplus electricity back to the grid (zero net export), have seen more rapid deployment reaching 5.6 MW of installed capacity.

Based on interviews with installation firms active in Kosovo, and feedback from existing and potential investors, this self-consuming segment of solar PV (including prosumers, behind-the-meter, and off-grid) is expected to grow rapidly reaching up to 240 MW of installed capacity by 2030.

To better understand this potential it is necessary to split the self-consuming generators into the following three categories:

- Households;
- Public Institutions; and
- Private Businesses.

## **PROSUMER HOUSEHOLDS**

Based on the ERO published list of authorized self-consumption generators, the average installed capacity of a household solar PV system is just above 6 kW.

Assuming that only 1.5% of households (approximately 8,000 households out of 517,486 current household metering points), decide to benefit from a Prosumer support scheme, about 50 MW of solar PV capacity could be installed by 2030. This estimate is based on data collected from several solar PV installation firms in Kosovo, based on their orders from customers, interest expressed and growth trends.

The installation of 50 MW of household rooftop solar PV would generate about 3% of the total electricity consumed by households in Kosovo.

## **PROSUMER PUBLIC INSTITUTIONS**

There are about 2,000 public buildings in Kosovo, as estimated by the studies on energy efficiency in public buildings. Public buildings include central and local government institutions, public utilities, public schools (primary, secondary and universities), dormitories, healthcare facilities (primary, secondary and tertiary), courts, police stations, army points and prisons.

Electricity demand in public buildings varies significantly and the capacity of solar PV required to meet demand needs to be assessed in tandem with the assessment of the potential for energy efficiency in these buildings.

This report assumes that public buildings could install 50 MW of solar PV capacity by 2030. This estimate is reasonable even considering that installation in public buildings is procedurally more complex as it involves undertaking assessments, securing funding, and inviting bids through the public procurement processes.

## **PRIVATE BUSINESSES**

Since 2013, private business installations of solar PV for self-consumption have grown steadily to over 200 installations with a total capacity of 7 MW by the end of 2020. The majority of these projects are behind-the-meter installations, with only 30 private business projects benefiting from the status of Prosumer.

Due to the current limitation of 100 kW for prosumers connected to connected to the low voltage network, many businesses that need higher capacities are unable to fully benefit from net-metering.

Therefore, some investments and installations have been postponed. This limitation is discussed more fully below and in the Annex 3 report.

When this limitation is increased to 400 kW or 500 kW, private businesses could install up to 150 MW of new capacity by 2030. This projection is based on initial surveys of solar PV installers and the private businesses themselves.

### **CATEGORY 3. AGRICULTURAL GRANTS AND SUBVENTIONS**

Since the introduction of grants for agricultural solar PV in 2014, a total of 1,073 farmers have installed 3.7 MW of solar PV system through 2019. The majority of these installations have capacity between 1-5 kW and are usually off-grid installations supplying water pumps. Agro-processing facilities have installed capacities of between 6-12 kW.

Going forward, the Ministry of Agriculture plans to continue disbursing grants for agricultural solar PV. Farmers and agro-processors that have installed solar PV have seen cost savings, and those with net metering additionally benefit from transmitting excess power during the day to the grid which then helps offset the demand at night.

Solar PV installations in the agricultural sector are expected to continue to grow and reach 30 MW of capacity by 2030.

### **CATEGORY 4. LARGE UTILITY-SCALE PROJECTS**

In May 2020, the Kosovo Energy Corporation (KEK) completed a preliminary Feasibility Study for a 100 MW solar PV facility to be installed on the former ash dump area next to Kosovo A power plant. KEK is now exploring various options for financing all or part of the site for development. In response to KEK's inquiry for Instrument for Pre-Accession Assistance (IPA) funding, the European Union (EU) in Kosovo, in collaboration with German KfW, are evaluating options to support KEK with financing (grants in combination with loans) to develop 50 MW of capacity. The solar PV output is envisaged to be sold to the electricity market as part of KEK's generation portfolio.

In addition to KEK's own initiative, the Ministry of Economy and Environment (MEE) is seeking alternative approaches to develop large scale solar PV projects based on a competitive process and with private sector involvement. The alternative approaches include tendering for a Public-Private-Partnership (PPP) project, and an Auction Process. Both approaches will offer long-term electricity off-take arrangements for developers offering the lowest tariff. These approaches are outlined below:

- **Tendering/PPP based project(s)**  
MEE in cooperation with the International Finance Corporation (IFC) is evaluating the possibility of developing a PPP project based on competitive selection process for a 50 MW solar PV project. The terms of cooperation between MEE and IFC are being finalized and the process is expected to begin in early 2021.
- **Auction based project(s)**  
The European Bank for Reconstruction and Development (EBRD) is supporting the MEE and ERO to develop the legal, regulatory and procurement framework for an auction process for the development of new large-scale RES capacities. About 200 MW of wind and solar energy

plants are expected to be developed through this auction process. For solar PV it is envisaged to have two projects of 50 MW each.

## **CATEGORY 5. PRIVATE SECTOR INITIATIVES**

The Law on Strategic Investments, adopted on February 8, 2017, establishes the administrative procedures and criteria for implementation of strategic projects in Kosovo, including for energy projects. The minimum investment needed to gain the status of strategic investment for an energy project is thirty (30) million Euros. Any investor who wishes to propose a strategic investment in the energy sector must submit a written request to the Investments and Enterprise Support Agency (KIESA) complying with requirements of applicable secondary legislation. The status of Strategic Investment does not waive the requirements for the investor to obtain all necessary authorizations and licenses from the ERO.

KIESA has confirmed that they have received 20 applications for energy projects, with solar PV representing about half of the applications. Due to confidentiality requirements pertaining to the review process, KIESA could not provide details of the applications. To date, none of the proposed solar PV projects have applied to obtain Authorization for Construction of New Generation Capacities from the ERO. However, based on the information published by the Transmission, System and Market Operator of the Republic of Kosovo (KOSTT) and discussions with the private sector, approximately 380 MW of solar PV have been proposed by private investors. The proposed project sizes vary considerably, ranging from 9 MW to 190 MW.

Projects developed as Independent Power Producers that do not benefit from Status of Strategic Investment could, in principle, enter into 15-year PPA with the Market Operator, with the electricity price determined by the ERO “Methodology on calculation of reference price for energy generated from renewable sources”. Alternatively, the proposed projects could sell their output on the open electricity market based on bilateral contracts or export arrangements.

There are many factors that can impact the outcome of these private sector led initiatives. A major obstacle could be obtaining financing in the absence of long-term PPAs with guaranteed prices, suitably backed with appropriate international risk mitigation instruments.

## FINANCING SOLAR PV IN KOSOVO

Kosovo has so far developed only one considerably large renewable energy project based on the FiT support mechanism, in addition to six small solar PV farms with total capacity of 10 MW and thirteen small hydro projects with total capacity of 106 MW. The one large project is the 32.4 MW KITKA wind farm (with General Electric turbines) located in the Kamenica Municipality in Eastern Kosovo, which was the first wind farm in Kosovo and became operational in October 2018.<sup>1</sup> The project cost an estimated EUR 73 million and was developed by Air Energy SH.P.K., a special purpose vehicle (SPV) fully owned by Guris Insaat ve Muhendislik A.S, a company which is part of the Turkish engineering and construction conglomerate Guris Group. The project was in part, financed by the European Bank for Reconstruction and Development (EBRD).<sup>2</sup> It was recently reported that the grid operator KOSTT has signed a connection agreement to expand the capacity of the wind farm by 20 MW, which is expected to be operational by 2022.<sup>3</sup>

Kosovo is also currently developing a 105 MW wind farm – the Bajgora wind farm – which is scheduled for completion in April 2021. The Bajgora wind farm is being developed in the Mitrovica municipality by Sowi Kosovo LLC, which is majority-owned and controlled by Enlight Renewable Energy Ltd, an Israeli renewable energy company.<sup>4</sup> The EBRD has loaned EUR 58 million to the project with additional financing from Erste Group Bank and NLB Bank, which are benefiting from cover provided by the German export credit agency Euler Hermes. When completed, the Bajgora wind farm will be the largest generation project constructed in Kosovo since the 1980s.

In addition to the above two wind farms, it is reported that additional wind (235.1 MW) and small hydro (43 MW) projects have received Preliminary Authorization for construction and are at various stages in receiving the final authorization, subject to availability of defined RES targets for each type of RES.

No large solar PV project above 3 MW has thus far been developed in Kosovo, though there are plans by KEK to develop 100 MW solar PV, on top of former ash dump area next to Kosovo A power plant. A preliminary project feasibility study has been developed. Other large solar PV projects are reportedly under consideration with interest from the EBRD, which is supporting Kosovo to develop an auctions regime to competitively procure solar and wind energy projects, the IFC, KfW, EU, and other international development institutions which are interested in supporting financing for Kosovo renewable energy projects.

## COUNTRY INVESTMENT RISK PROFILE

The U.S Department of State has assessed that while Kosovo could attract foreign direct investment (FDI), political instability, weak legal frameworks, a lack of contract enforcement and the perception of corruption are impediments.<sup>5</sup> Despite these concerns, the country attracted an FDI of about \$292 million in 2019, with much of it directed towards real estate, financial services, and the energy sector. The impact of COVID-19 on the economy however, led to a negative growth rate in 2020, and is

---

<sup>1</sup> [www.kitkawpp.com](http://www.kitkawpp.com).

<sup>2</sup> <https://www.ebrd.com/work-with-us/projects/psd/kitka-wind.html>.

<sup>3</sup> <https://www.ewind.es/2020/09/11/kosovo-signs-agreement-for-wind-energy-expansion/77127>.

<sup>4</sup> <https://www.ebrd.com/news/2019/575m-ebrd-loan-to-build-kosovos-biggest-wind-farm.html>.

<sup>5</sup> Investment Climate Statements: Kosovo, US Department of State. 2020. Washington DC.

expected to lead to continued constrained growth in 2021, as projected by the World Bank (WB), International Monetary Fund (IMF) and the EBRD.

Despite the weaknesses and impediments to the FDI, the U.S Department of State notes that laws and regulations are largely modeled on EU standards and international best practices and protect investments, at least in principle. Kosovo also has an open market economy, with market-determined interest rates, with credit available to domestic and foreign investors. Capital sourcing is subject to country's regulatory framework that is consistent with EU legal framework, and the Central Bank of Kosovo allows free flow of capital.

The flat 10% corporate tax rate, the law on strategic investment, the law on business organizations, and other improvements to the business enabling environment has helped improve Kosovo's ranking on the WB's Doing Business Report (out of 190 countries) moving from 113 in 2010, to 57 in 2020.<sup>6</sup> Kosovo does not have a country credit rating and is not rated by any of the major credit rating agencies, which could be an impediment to foreign private investors in the energy sector and also make capital more expensive. However, the U.S State Department, in its assessment of the investment climate states that, "Despite the challenges, Kosovo has attracted a number of significant investors including several international firms and U.S. franchises"<sup>5</sup>. Large scale investment in renewable energy by foreign investors and project developers will likely be driven by their appetite for risk and the long-term potential they envision for the country.

## LOCAL CAPITAL MARKETS AND BANKS

Kosovo does not have an independent monetary policy and the Euro is the official currency despite the country not being part of the Eurozone. Kosovo's commercial banks are largely foreign owned, and the U.S Department of State assesses the private banking sector to be well capitalized and profitable, with total assets of the banking sector of about EUR 8.5 billion. The non-performing loan ratio was 2.5% in 2020<sup>5</sup>, but this could rise due to the economic impacts of COVID-19 on local businesses in 2020 and 2021.

Lending for long-term investments is limited, since among other reasons, banks depend on short-term deposits for lending. Local average interest rates are reported to be about 6.3% in 2020. In addition to the commercial banks, there are microfinance institutions (MFIs) and non-bank financial institutions including commercial finance companies and leasing companies, that provide working capital and medium-term investment capital.<sup>7</sup>

There is very little non-recourse project finance available in Kosovo, and most lending includes overdrafts, lines of credit and term loans, often with high very collateral or secondary income requirements. The Kosovo Credit Guarantee Fund (KCGF), established in 2016, is a "credit guarantee facility issuing portfolio loan guarantees to financial institutions to cover up to 50% of the risk for loans to micro, small, and medium enterprises (MSMEs)".<sup>8</sup> KCGF has been supported by the Ministry of Trade and Industry, the United State Agency for International Development (USAID), KfW, SIDA, European Investment Bank (EIB), the WB, and MFK. The KCGF has already facilitated over 213 million

---

<sup>6</sup> [www.doingbusiness.org](http://www.doingbusiness.org).

<sup>7</sup> Kosovo has nine commercial banks, of which seven are foreign-owned, and about 20 micro-finance and non-bank financial institutions.

<sup>8</sup> The Kosovo Credit Guarantee Facility, Kosovo (<https://fondikgk.org/en/home-2/>).

EUR in over 5,600 loans to businesses that would not have otherwise been able to obtain finance.<sup>9</sup> In addition, the KCGF has helped reduce collateral requirements and increase tenors.<sup>10</sup>

There is almost no angel, private equity, venture capital and corporate venture capital investment in Kosovo, although the startup and entrepreneurial ecosystem is now starting to flourish. Kosovo does not have a stock market and the only securities traded are government issued bonds<sup>5</sup>.

Local banks and MFIs have financed or are interested in financing, solar PV projects (these typically have been small capacity projects such as off-grid, behind-the-meter, prosumer, and up to 3 MW grid-connected solar PV installations). A survey of local banks and major MFIs by the KESS team indicated that all nine banks and the four largest MFIs were interested in financing solar PV projects based on their normal lending practice.<sup>11</sup> The largest leasing company has not financed solar PV projects to date but is now interested and is developing a lease product for solar PV installations.<sup>12</sup> The KESS survey of banks indicated that the demand for financing of solar PV installations has thus far been low. Lower costs of solar PV and increased lending experience specifically for solar PV installations is likely to improve the risk assessment and credit underwriting processes of the banks, leading to increased lending.

## **PROSPECTS FOR INVESTMENTS IN THE LARGE RENEWABLE ENERGY PROJECTS**

Credit in the local capital markets is available principally for smaller projects up to about 3 MW in capacity (larger projects up to 10 MW could also perhaps be financed by a syndicate of local banks). Larger-scale energy projects will likely require foreign borrowings from external sources such as IFIs, bilateral donors, and commercial banks. The IMF reports that favorable interest costs, longer maturity, and a grace period from IFIs makes official financing the most suitable financial instrument to fund capital projects.<sup>13</sup> The additional benefit of IFI borrowing is the provision of technical assistance for project selection and development in a transparent and competitive manner which can catalyze private capital. The use of robust PPP frameworks could help leverage private capital but results in contingent liabilities due to the perceived political risk and limited financial capacity of electricity sector institutions to make long-term commitments<sup>14</sup>. Guarantees backstopped by the government may be essential to attract capital as discussed later in this report.

The US Overseas Private Investment Corporation (OPIC) has been active in Kosovo for a long time, as has the US Development Credit Authority (DCA). Both are now part of its successor, the U.S. International Development Finance Corporation (DFC). DFC is interested in supporting energy investments in Kosovo, and could potentially provide equity, debt, political risk insurance, loan guarantees and other investment vehicles to energy projects.

---

<sup>9</sup> Kosovo Credit Guarantee Fund ([fondikgk.org](http://fondikgk.org)).

<sup>10</sup> The partner banks of KCGF are Raiffeisen, ProCredit, NLB, TEB, BKT, BEK and BPB. Raiffeisen Leasing is also a partner.

<sup>11</sup> Banks - Raiffeisen, ProCredit, TEB, BEK, NLB, BKT, IS, Ziratt, and BPB; MFIs - Finca, KEP, AfK and KRK. ProCredit provides a preferential interest rate which is 0.5% lower for energy efficiency and renewable energy projects.

<sup>12</sup> Raiffeisen Leasing.

<sup>13</sup> International Monetary Fund. February 2018. Republic of Kosovo: Selected Issues, IMF Country Report No. 18/31. IMF. Washington DC.

<sup>14</sup> Kosovo has had some successful PPPs, including the Prishtina International Airport new terminal.

Kosovo is a member of the IMF, the EBRD, and the World Bank Group (WB, IFC, and the Multilateral Investment Guarantee Agency (MIGA)). Bilateral and multilateral DFIs, including the EBRD, WB Group, EIB, and the German development bank KfW, are all interested in investing in the energy sector in South East European countries including Kosovo.<sup>15</sup> The International Renewable Energy Agency (IRENA) reports bilateral and multilateral DFIs have invested \$3.2 billion in RE projects in Southeast Europe between 2001-2018, accounting for 17% of total investment.

An important consideration for financing RE projects in Kosovo would be the risk premium on the cost of capital due to the political, policy, and off-taker risks. The use of the Euro by Kosovo helps eliminate currency fluctuation risks which are common to financing projects in other Southeast European countries. IRENA notes that blended finance, which combines development assistance with other private or public resources to leverage additional funds from other sources can help leverage additional private investments and overcome financing barriers. Given that public finances in Kosovo are scarce, the use of public finance is perhaps best used to de-risk private investment and lower the risk premium through provision of sovereign guarantees. The potential to export power from Kosovo to regional countries, and the recent agreement to participate in the common electricity market could also help lower investment risks.<sup>16</sup>

## **DFI INVESTMENT IN LARGE RE PROJECTS IN KOSOVO**

The EBRD was the first DFI to finance a large scale RE project in Kosovo when it provided a senior long-term loan to finance the construction of the 32.4 MW Kitka wind farm. The project was implemented by Air Energy SH.P.K., a special purpose vehicle (SPV) owned by the Guris Group of Turkey. EBRD financed EUR 17.5 million of the EUR 73 million total project cost. EBRD has also loaned EUR 58 million to Sowi Kosovo LLC to finance the 105 MW Bajgora wind farm in northern Kosovo, which is under construction and is expected to be operational in 2021. EBRD financing is about half of the total financing for the project, with the remaining provided by Erste Group Bank and NLB Bank, both of which are benefiting from cover provided by the German export credit agency Euler Hermes<sup>4</sup>.

The IFC is reportedly advising the government of Kosovo on the procurement of 50 MW of utility scale solar power generation capacity. IFC would provide transactions advisory to the government and also provide financing to potential bidders. The EBRD is presently supporting Kosovo develop a reverse auctions mechanism to competitively procure RE projects. And KEK, the utility, is considering developing a 50 MW solar PV plant with financing from KfW and/or a potential grant from the EU.

---

<sup>15</sup> IRENA. 2019. Renewable Energy Market Analysis. Southeast Europe. IRENA, Abu Dhabi.

<sup>16</sup> In 2020, Kosovo agreed with the association of European grid operators to connect with the continental European grid, allowing it to operationalize an under-used 400 kV interconnection with Albania.



## FINANCING LARGE-SCALE SOLAR PV PROJECTS IN KOSOVO – AN EXAMPLE

### EXAMPLE OF A 50 MW SOLAR PV PROJECT

To illustrate the financing instruments and options for large grid connected RE projects in Kosovo, a basic project finance model was developed for a 50 MW solar PV plant. The inputs to the model were assumed based on solar irradiation data and typical plant costs available for Kosovo and validated by information from a preliminary feasibility study for large solar PV project prepared for KEK.<sup>17</sup> A financial model was used to estimate the levelized cost of electricity (LCOE) and the internal rate of return (IRR) based on assumptions for financing the plant. Assumptions for financing were based on typical terms which could be available for such projects from DFIs and based on the experience and knowledge of the KESS team. The financing structure and terms have a very material impact on the LCOE, but the terms have not been discussed with the DFIs for this report. The results of the analysis and the implications for financing the hypothetical plant are realistic but illustrative.

### PROJECT STRUCTURE

Project companies could be established as a joint venture, a partnership, a limited partnership, or a limited company. The limited company is the most commonly used structure for establishing an entity to develop an energy project. Under this structure, a company is established as a special purpose vehicle (SPV) by the project sponsors and is used to hold just the assets of the project to be developed. The project sponsors hold shares/ownership in the SPV, and the assets are placed in the SPV. The SPV is the borrower of any external financing required by the project. The advantage of this structure is that the project sponsors have limited liability in the project and the assets of the SPV and any guarantees and insurance provided by the sponsors are used to secure any debt incurred by the company. The shareholder agreement decides the ownership structure in the SPV. The SPV structure is amenable to a PPP structure whereby the public utility KEK could be a shareholder in the SPV and could contribute its investment (equity and/or debt) in any manner optimal for the public entity and as per the shareholder agreement. For instance, KEK could take proportional ownership in the SPV established to develop the solar PV project and contribute equity or land or as its share of investment.

The structuring of the 50 MW solar PV project company as a SPV is consistent with the project structure for development of the large wind energy projects in Kosovo, which too were developed by project sponsors establishing an SPV to hold and operate the assets of the wind farms. However, the wind projects were not structured as a PPP and were owned entirely by private project sponsors. Generally, the project structure is decided based on legal, tax, regulatory and accounting issues which govern the ownership and operations of companies in a country.

### PROJECT FINANCING STRUCTURE

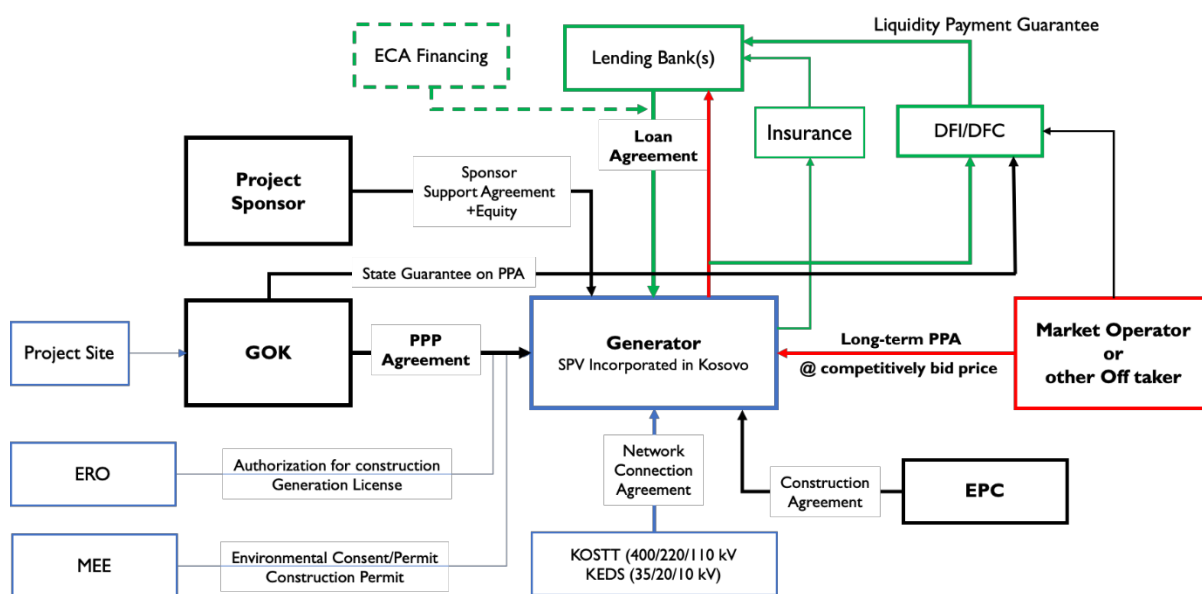
Different financing structures could be considered including public finance, grant financing, equity financing, corporate or balance sheet financing, and project finance based on the financing environment and incentives available. Based on the experience of the wind energy projects developed and under

---

<sup>17</sup> KEK provided information on a feasibility study for a 50 MW Solar PV project (confidential).

construction in Kosovo with financing provided in part by EBRD, project finance would be a good option for financing the project whereby debt service obligations are met entirely from the cash flows generated by the project with the lender having limited or no recourse to the project sponsor's parent corporate balance sheet. An SPV would be established to own the assets and liabilities of the company, and the assets of the project and any other guarantees required or provided by sponsors/shareholders would be the primary recourse to the lenders. The project finance structure also permits the revenues from the project to be ring-fenced to ensure that debt service and other payment obligations are met first prior to providing dividends to project sponsors.

Since the SPV is the debtor and the project cash flows are the primary source to service debts and meet other costs and obligations, the PPA with the off-taker and its provisions becomes very critical to all project parties. Risks associated with committed payments from KOSTT, the market operator and public sector off-taker, over the course of a long-term PPA, would very likely require credit enhancement support from bilateral and multilateral agencies and export credit agencies. Guarantees from DFIs would generally require a sovereign guarantee from the government. It is assumed that the PPA for the solar PV project is based on a take-or-pay contract requiring the off-taker to dispatch all power produced by the plant and/or pay for the contracted amount in accordance with the provisions of the PPA. The project financing structure along with support mechanisms (guarantees) is illustrated in Figure 2.



**Figure 2: Structure of a 50 MW Solar PV Project**

**THE POWER PURCHASE AGREEMENT (PPA)**

It is assumed that the power from the solar PV plant is sold to KOSTT, the market operator in Kosovo, under a long-term PPA. The possibility of establishing the SPV as a merchant power plant selling power in the open market has not been considered. While a long-term PPA gives comfort to lenders, there is also a perceived risk of committed payments over the term of the PPA, especially since the off-taker is a public entity which is not creditworthy and is subject to shifts in policies or political interference. The provisions of the PPA are thus critical to make the project bankable.

Kosovo's experience with the two large wind energy projects with EBRD as a lead financier provides comfort since the PPAs for these projects can serve as a basis to develop a bankable PPA for the solar

PV project. The PPA for the EBRD financed projects would have ensured that the provisions of the PPA are aligned with project agreements such as the grid connection agreement, lending agreements, Engineering-Procurement-Construction (EPC) and operations and maintenance contracts. These provisions would provide precedence to developing a standardized PPA for the solar PV project (and for RE projects in general) with clarity on all commercial terms, the tariff, terms of payment, operational dates, performance metrics, and provisions for termination, which reduce risks and protect the rights of all counterparties. A robust PPA approved by ERO, the electricity regulator in Kosovo, will be critical for project financing of the solar PV project.

## FINANCIAL MODEL

A basic financial model was used to assess the viability of the project. The financial model was run from the perspective of project sponsors who may seek debt financing from DFIs and commercial banks. The Cost of Renewable Energy Spreadsheet Tool (CREST) developed by the National Renewable Energy Laboratory (NREL), an agency of the U.S Department of Energy, was used to model the cash flows from the solar PV project as a first approximation.<sup>18</sup>

The power generation from the project is estimated based on solar data for Kosovo and based on information in a preliminary feasibility study prepared for KEK. The project is estimated to cost about \$40 million with the exception of land costs, which is assumed to be provided free from KEK either as equity to the SPV or on a land lease. The debt equity ratio is assumed to be 70:30, with equity from project sponsors directly provided to the SPV and debt provided by lenders on a limited-recourse basis. The interest rate on the term debt is assumed to be 4.0% with 1.0% lender’s fee for a loan tenor of 15 years. The cost of debt is based on typical terms which could be available from DFIs for an energy project in Kosovo, but this has not been confirmed with the DFIs. These are all-in rates but do not fully account for the cost of risk mitigation, which would need to be negotiated with lenders and DFIs. A 25-year fixed PPA is assumed to calculate project cash flows and the cash available for debt service is calculated after accounting for operational expenses, working capital, and tax on revenues. A Debt Service Coverage Ratio (DSCR) of 1.2 is assumed in the analysis, which is typical for DFI financed projects. The tariff at which cash flows from the project were adequate to service the debt and provide an adequate return to project sponsors was estimated using the model. The assumptions made for the financial model are consistent with data used in the preliminary project feasibility study prepared for KEK. Other assumptions required for modeling the cash flow analysis are consistent with data from IRENA, which provides data on capital and operational costs of solar PV projects.<sup>19</sup> The assumptions made as inputs to the model are provided in Table I.

**Table I: Summary of Inputs to Financial Model for Large-Scale Solar PV Projects**

Description of Input	Units	Input Value
Generator Nameplate Capacity	kW dc	50,000
Project Useful Life	years	25
PPA period	years	25

<sup>18</sup> "The CREST model is a cost-of-energy analysis tool. The model determines minimum revenue per unit of production needed for a renewable energy project to meet its investors' assumed minimum required after-tax rate of return.

<sup>19</sup> IRENA. 2020. Renewable Power Generation Costs in 2019, International Renewable Energy Agency, Abu Dhabi.

Installation Costs		
Generation Equipment Cost	\$	\$ 15,000,000
Balance of Plant	\$	\$ 20,000,000
Interconnection	\$	\$ -
Development Costs & Fee	\$	\$ 2,500,000
Reserves & Financing Costs	\$	\$ 2,332,133
Total Installed Cost (before rebates/grants, if any)	\$	\$ 39,832,133
Operations & Maintenance		
Fixed O&M Expense, Yr. 1	\$/kW-yr. dc	9
O&M Cost Inflation, initial period	%	1.60%
Construction Financing		
Construction Period	months	12
Interest Rate (Annual)	%	4%
Permanent Financing		
% Debt (% of hard costs) (mortgage-style amort.)	%	70%
Debt Term	years	18
Interest Rate on Term Debt	%	3%
Lender's Fee (% of total borrowing)	%	1%
Required Minimum Annual DSCR		1.2
Senior Debt		
Senior Debt	\$	\$ 26,250,000
Equity (funds balance of hard costs + all soft costs)	\$	\$ 13,582,133
Total Installed Cost	\$	\$ 39,832,133
Corporate Income Tax Rate		
Corporate Income Tax Rate	%	10%
Depreciation		20-year SL

## FINANCIAL MODEL RESULTS

It is estimated that a 50 MW solar PV project in Kosovo with assumptions as described above would result in a tariff of 6.95 €/kWh. The after-tax equity IRR for equity investors would be about 10.03%. The Net Present Value (NPV) over the life of the project is positive at about \$33,000. These results are based on assumptions made in the financial model. A more rigorous analysis based on detailed estimation of capital and operational costs and other model inputs, along with discussions with DFIs on proposed term sheets for a solar PV project in Kosovo will help refine the calculations and make a better estimate of the tariff. Better terms for debt financing and long term PPAs will lead to lower tariffs. For instance, reducing the interest rate on debt to 3.0% and increasing the tenor to 18 years (which is possible through DFIs) would lower the tariff to about 6.55 €/kWh. While these estimated tariffs are higher than that generally seen in global auctions for solar PV projects, it must be stressed that the development of an auction process with standardized contracts (as presently being supported by the EBRD) would lower the tariff. The purpose for this report is to provide a realistic but illustrative example to discuss the key issues relating to financing large-scale solar PV projects in Kosovo.

## BENEFITS FROM CREDIT SUPPORT MECHANISMS

The tariff could potentially be lowered with credit support mechanisms such as carbon credits, Renewable Energy Purchase Obligations (RPOs), VAT and duty exemptions, etc. For instance, RPOs oblige the distribution and supply utilities to purchase power from RE generation sources, which reduces the risk for off-take of power and could lead to higher clearing prices in competitive power markets. This is presently not an option for Kosovo, which does not have adequate RE generation and an RPO market.

The solar PV project would however help Kosovo meet its RE generation goals consistent with EU policies. Kosovo is not a signatory party to the United Nations Framework Convention on Climate Change (UNFCCC) however, Kosovo is signatory party of Energy Community Treaty and has obligation to achieve the targets set for greenhouse gas (GHG) emissions. While Kosovo has prepared GHG inventories for some years, it does not have a carbon pricing framework or scheme in place.

## PROJECT FINANCING OPTIONS FOR A 50 MW SOLAR PV PROJECT

As noted previously, financing solely from domestic commercial banks is unlikely given the debt requirement of about \$28 million and the limitations of how much a bank can lend to a single borrower as a percentage of its Tier 1 capital, according to Central Bank regulations. However, a syndicate of local banks could potentially finance the project if sponsors with strong balance sheets are willing to provide collateral or if local banks could offer favorable terms with long tenors and limited recourse under a project finance structure. Given the political, policy and off-taker risks in Kosovo, the best options for financing would likely be lending from DFIs in combination with foreign or domestic commercial lenders and equity from private sponsors. Six of the seven local banks expressed interest in co-financing these projects in syndicate with international investors and/or lenders. Some of the options for DFI financing in Kosovo include examples described below.

EBRD has invested in wind energy projects in the country and is presently supporting the development of an auctions process to competitively procure renewable energy projects. EBRD can provide The Euro Interbank Offered Rate (EURIBOR) based financing in Euros, which will not require a currency swap since project cash flows in Kosovo are in Euros. EBRD can finance private project sponsors and generally provides senior debt for a portion of project costs (generally up to 50%). The financing terms

provided by EBRD to the Kitka and Bajgora wind farms in Kosovo are not known. The Bajgora wind farm project had a guarantee from the German export credit agency, Euler Hermes, but the cover provided by the guarantee and its terms are not known.

The WB and the IFC could also finance projects in Kosovo, though they have not yet financed RE projects in the country. The WB is however supporting a project to enhance the policy and regulatory environment for renewable energy and energy efficiency.<sup>20</sup> The WB though, can only lend if projects are structured as a PPP with KEK as a shareholder in the SPV, with a backstopping sovereign guarantee provided by the government of Kosovo. The WB can provide Euro financing for projects in Kosovo.

The IFC has invested in projects in Kosovo but not yet in the energy sector. The IFC is reportedly seeking to replicate its Scaling Solar program to support Kosovo develop solar PV projects. Under the Scaling Solar program, the IFC provides support for the development of standardized bid documents and project documents and agreements. Under the scheme IFC also provides stapled financing, which essentially is a common financing term sheet provided to all eligible bidders. Bidders which meet IFC due diligence requirements can access credit, which provides some certainty that the project will reach financial close. While there are provisions to permit other sources of financing, which the project sponsor may have, the preference is for IFC to finance the project. This may not be desirable for other DFIs such as the EBRD, which has already financed RE projects in Kosovo. IFC project documents under Scaling Solar cannot be changed and would be different from project documents being developed by the EBRD. IFC can only finance private sponsors and can provide debt and also take an equity position in the project. The IFC can provide EURIBOR based financing in Euros, which will not require a currency swap since project cash flows in Kosovo are in Euros.

The U.S DFC is another option to provide both debt and equity to the project. DFC has so far not financed any projects in Kosovo and is reportedly seeking opportunities in the energy sector.<sup>21</sup> The DFC can provide the entire debt for the project given the relatively small amount. DFC could also provide guarantees though its appetite to provide cover to other financiers needs to be verified. DFC may prefer a negotiated deal over a tendered project and seek US investors or equipment for the project. DFCs strategy for financing energy projects in Kosovo needs to be discussed and confirmed with the bank. A potential drawback to DFC financing is that it provides London Inter-bank Offered Rate (LIBOR) based US dollar financing, which will require incurring additional costs for a currency swap to mitigate currency risks since project cash flows would be in Euros. A LIBOR currency swap could add 200 bps to the cost. However, DFC could choose to provide financing at attractive terms to mitigate the additional expense of a currency swap. DFC appetite to finance a relatively small project needs to be confirmed.

The German development bank KfW is another option to finance the solar PV project in Kosovo. KfW has reportedly been in discussions with KEK to finance a solar PV plant and could offer preferential terms. The EU is also a potential source of financing and could provide grant financing to Kosovo. Grant financing could be blended with DFI financing to lower the cost of funds and lower the

---

<sup>20</sup> World Bank. 2020. Kosovo Energy Efficiency and Renewable Energy Additional Financing (PI67572). Combined Project Information Documents / Integrated Safeguards Datasheet (PID/ISDS). World bank. Washington DC.

<sup>21</sup> As noted earlier, its predecessor OPIC and USAID's DCA have provided guarantees to local banks for lending to some sectors such as SMEs and agriculture.

tariff. But any grant financing would necessarily be for a public entity such as KEK and not to private project sponsors.

The EIB has been active in Kosovo since 2007 and is another potential source for financing large solar PV projects. EIB could provide both loans and guarantee instruments to private project developers<sup>22</sup>.

In addition to DFI financing, it is likely that other commercial banks would participate in a syndicate to finance the project. Any partial financing from a DFI creates a halo effect and helps leverage commercial financing. Commercial banks usually find comfort in the fact that a project and sponsor who can meet DFI due diligence and environmental and social safeguards requirements would be a low-risk investment.

Regardless of the financing option for the project, it is very likely that DFIs and commercial financiers will require cover from guarantees to mitigate the risks of payment from the off-taker and project termination risks, and political risks. Commercial risk instruments would be expensive and risk instruments from DFIs require government backstop with a sovereign guarantee. Financial risk mitigation instruments are discussed in a separate section below.

### SAMPLE TERM SHEETS FOR FINANCING THE PROJECT

Project sponsors usually seek a term sheet from potential financiers once a basic and general agreement is reached on terms of the loan. While the term sheet is a non-binding document, it provides the general provisions of the loan prior to actual underwriting. The term sheet could also be a conditional letter of intent or commitment to provide financing and provides terms and conditions for financing including the interest rate, tenor, guarantees required and lender's fee. The term sheet is finalized after completion of due diligence of the project sponsor and after any condition's precedent are met. It is likely that project sponsors will seek term sheets from multiple DFIs and commercial banks to obtain the best financing terms. DFIs broadly offer similar term sheets with some differences in specific provisions. Some of the key elements in a term sheets are summarized in Table 2.

Actual term sheets will include specific provisions including performance bonds, security structure, and events of default. Typical terms offered by DFIs was used to model the sample 50 MW solar PV project.

---

<sup>22</sup> Since 2007, EIB has financed 6 projects in Kosovo totaling 240 million EUR. In the financial sector, the European Investment Fund (EIF) – a part of the EIB Group - has, through the Western Balkans Enterprise Development and Innovation Facility (WBEDIF), provided loan guarantees to ProCredit Bank to facilitate lending to SMEs, and under the COSME Loan Guaranty Facility, provided a counter-guarantee to KCGF to facilitate new lending to over 2,200 SMEs in the amount of 90 million EUR in two years. The WBEDIF, through the Western Balkans Expansion Fund and Guaranty Facility, has provided over 55 million EUR to Kosovo providing loans at preferential conditions.

**Table 2: Typical Provisions in a Term Sheet**

<b>Key Terms</b>	<b>Units/Terms</b>
<b>Currency of facility</b>	EUR/ USD
<b>Total Facility amount</b>	EUR/ USD
<b>Max Debt/Equity ratio</b>	70/30 or 75/25
<b>Start of Availability</b>	Signing of financing documents
<b>End of Availability</b>	Construction period + months
<b>Grace period</b>	Typically, 6 months
<b>Door to Door Tenor</b>	Typically, 18 years
<b>Repayment periods</b>	semi-annual periods
<b>Amortization style</b>	Sculpted/mortgage style/Other
<b>DSRA required</b>	Typically, 6 months
<b>Min DSCR</b>	Specified at P50, P90, etc. (typically 1.2 – 1.4)
<b>Margin: Construction and Repayment Periods</b>	bps
<b>Base Rate During Construction/Operation Period</b>	Typically, 1-6 months EURIBOR/LIBOR
<b>Hedging required</b>	Construction/Operation period: % of debt
<b>Hedging Credit Spread</b>	Varies bps
<b>Interest Rate Hedging</b>	% of senior debt
<b>Upfront fee</b>	% of debt
<b>Commitment Fee</b>	% of applicable margin
<b>Agency Fee</b>	% of debt
<b>Covenants and CPs</b>	varies



## PROJECT RISKS AND GUARANTEES

### PROJECT RISKS

A solar PV project faces many risks both during construction and after the start of project operations. A few of the principal financial related risks of projects are summarized below. Note that this is not a listing of all risks associated with project development, construction, and operations.

**Table 3: Project Risks**

Key Financing-Related Risks	Risk Description
Foreign exchange risk	Does not apply in Kosovo since the country uses the Euro as the currency and most DFIs can lend in Euro's
Interest rate risks	Projects can be financed on fixed interest rates from DFIs and commercial banks and do not usually need interest rate swaps. But a variable interest rate would need interest rate swap
Counterparty credit risk	This relates to risks posed by the weak creditworthiness of public sector off-takers such as KOSTT
Policy and political risk	Risks related to change in policies, taxes, royalties, etc. which may impact project revenues
Business interruption risks	Risks related to interruption caused by any number of factors which may impact power generation and project revenues

Reducing project risks brings clear benefits to the project sponsor, and the inclusion of DFIs in the financing plan can help lower the risks perceived by other commercial lenders to the project since the DFIs can exercise greater leverage. Reducing risks enables project sponsors to obtain better financing terms at lower costs, which is key to lowering and optimizing the levelized cost of electricity generation from the project.

### GUARANTEES AND RISK MITIGATION INSTRUMENTS

Guarantee products can cover a range of sovereign or parastatal risks including default risk caused by the failure of the government to meet any contractual obligations such as payment obligations under the provisions of the PPA. Guarantee products are premised on the probability or likelihood of a call being made on an underlying commitment.

Most lenders providing project finance will require project sponsors to mitigate risks through appropriate mitigation instruments including external insurance policies. The WB provides guarantees, credit enhancement products and risk mitigation instruments to cover off-taker payment risks, regulatory risks, change in law and political force majeure. WB guarantees are available to projects supported by the government and require a sovereign counter guarantee. MIGA, on the other hand, provides a wide range of political risk insurance directly to private project sponsors without

involvement of the government. DFC could also provide guarantees to the project. Guarantees add to the cost of financing the project and could typically cost 100 bps or more of the amount to be insured in addition to other processing and application fees.

### STRUCTURE OF GUARANTEES FOR THE 50 MW SOLAR PV PROJECT

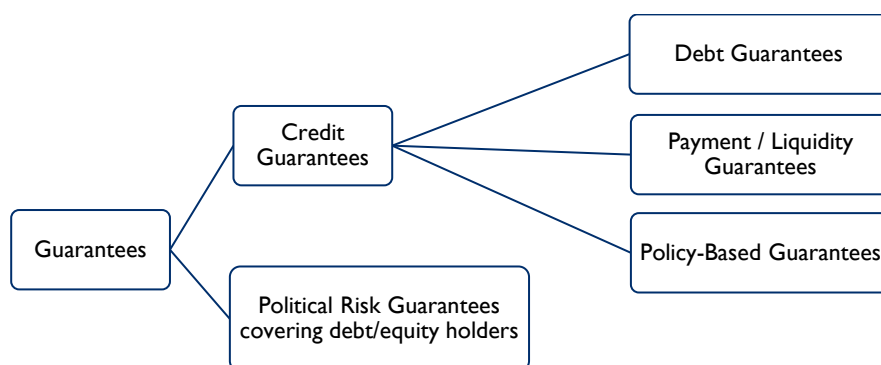
Kosovo as a member country of most DFIs, can generally avail DFI guarantee products for projects implemented in the country. The key entities in a guarantee structure are:

- Guarantor – The DFI guarantees payment to the beneficiary against Kosovo government-related risk (for KOSTT, payment default as the off-taker of power from the solar PV project).
- Obligor – The Kosovar government acts as primary obligor and commits to indemnify the DFI through a sovereign guarantee in case any of its guarantee is invoked.
- Beneficiary – The SPV, debt providers, equity investors or a financial institution depending on the kind of guarantee product.

The requirement for the Kosovar government to provide sovereign counter-guarantees depends on the requirements of the DFI offering the guarantee and its policies. Provision of a counter guarantee is in part a contingent liability for the government, which could limit its borrowing capacity. Guarantees without a counter-guarantee would generally be more expensive depending on the risk profile of the country.

In the case of the example described above, the 50 MW solar PV project, the SPV established to develop the project is assumed to sell power to KOSTT on the basis of a 25-year PPA. The estimated annual project revenues based on the estimated tariff is about \$4.5 million. KOSTT does not have a credit rating and its ability to meet payment obligations under multiple PPAs is not clear. This would cause the PPA to be less bankable and increase borrowing costs and the tariff.

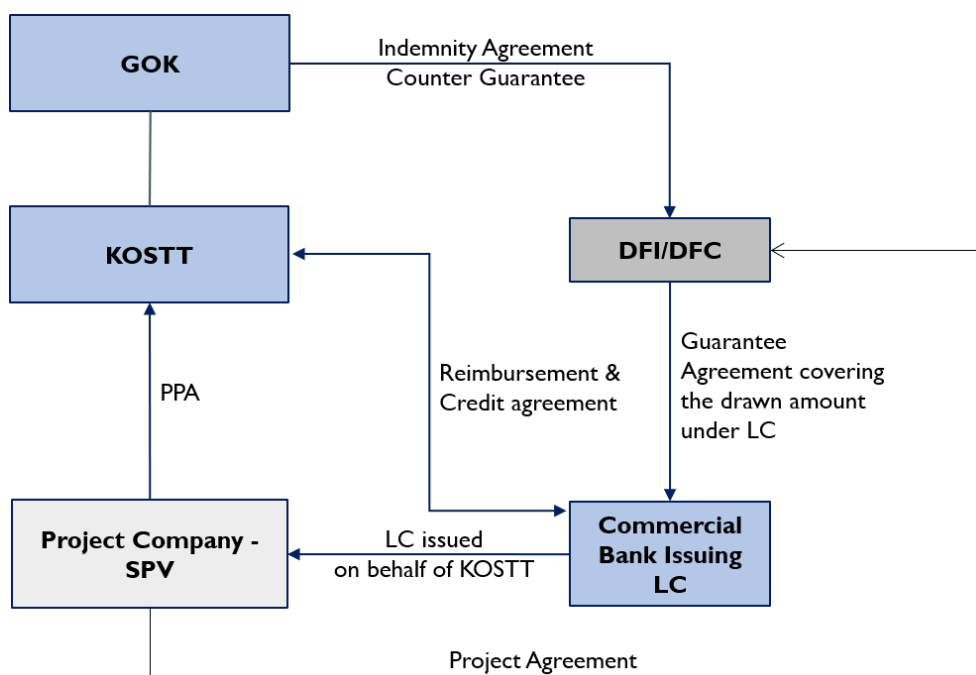
A DFI may consider providing guarantee products for a fixed value to be utilized for the single project or for a portfolio of similar RE projects planned for development in Kosovo. The guarantee could be leveraged to obtain DFI and commercial financing for projects at more preferential terms compared to financing terms in the absence of the guarantee. Figure 3 illustrates the different types of guarantees which could be provided to the solar PV project (or a portfolio of projects) to de-risk the project.



**Figure 3: Coverage Provided by Guarantees**

To guarantee PPA payments from KOSTT to the SPV, a bank could also issue a Letter of Credit (LC) to cover payments for three to six months. DFIs/DFC could provide a guarantee to the LC issuing bank, with a sovereign counter guarantee from the government. In case KOSTT fails to pay the SPV,

the LC bank would make payment to the SPV. KOSTT would be required to reimburse the LC bank within a specified time period. If KOSTT does not replenish the LC account, the LC bank would have recourse to the DFI guarantee (Figure 4). A similar guarantee structure could be designed to protect creditors from debt repayments to be made by the SPV.



**Figure 4: Liquidity/Payment Guarantee for the 50 MW Solar PV Project**

## SUGGESTED PROJECT STRUCTURE FOR THE 50 MW SOLAR PV PROJECT

As discussed in the sections above, it is suggested that the 50 MW Solar PV project be established as a SPV whose shareholders could include private sponsors and KEK under a PPP arrangement or be held by private sponsors with KEK providing land under a lease agreement. The project could be financed by DFIs such as the EBRD, IFC, KfW, WB, DFC, and commercial lenders, with additional guarantees provided by DFIs/DFC to provide cover for liquidity and debt payments and provide political and policy risk insurance. As noted earlier, financing from DFC would be LIBOR based US dollar financing requiring a currency swap. The EBRD, IFC, WB, KfW and European DFIs would be able to provide EURIBOR based Euro financing. The project structure and financing terms assumed in this illustrative analysis need be refined in consultation with stakeholders and potential financiers since these have a very material impact on the tariff.

## FINANCING OTHER SOLAR PV IN KOSOVO

This section describes the current financing landscape for small solar PV market segments and provides suggestions for improving financing options. As described under the KESS Activity I Report, the small and mid-sized market segments for solar PV project are classified as:

- Behind-the-meter or off-grid installations;
- Self-consuming generators under Support Scheme based on Net-metering (Prosumers);
- Solar PV generators under Support Scheme based on Feed-in Tariffs; and,
- Solar PV generators under Support Scheme based on Regulated Framework.

The above market segments differ in project size and in the purpose they serve. Behind-the-meter, off-grid, and prosumer installations are for consumers that are typically producing electricity for their own self-consumption to save energy costs. Prosumers are also connected to the grid with net energy metering, and can inject excess electricity back to the grid, or balance the energy on a period basis. Solar PV projects benefiting from feed-in-tariffs and a regulated framework are revenue generating businesses which sell power to the electricity grid.

## **BEHIND-THE METER / OFF-GRID INSTALLATION**

Surveys undertaken by KESS indicate there are currently at least 180 behind-the-meter installations in Kosovo totaling just over 5.6 MW. There are three primary classes of behind-the-meter installations of rooftop solar PV projects: agriculture, households, and businesses. The current financing landscape for each customer class as well as ways that financing options may be enhanced going forward is described below.

### **AGRICULTURE**

In the agricultural sector, most of the solar installations have been financed by grants from the Ministry of Agriculture, Forestry and Rural Development (MAFRD) since 2014. These installations ranging in size from 1-12 kW total about 3.7 MW. Discussions with farmers and agricultural processing facilities indicate that they are hesitant to take loans for such installations due to interest rates and fees, relatively short tenors, and additional collateral and security requirements. The availability of grants from MAFRD, which is likely to continue, are a disincentive to commercial financing of the rooftop solar PV projects.<sup>23</sup>

With solar PV prices decreasing, interest rates lowering and tenors increasing, debt financing will become more feasible. It is recommended that the agro grant schemes limit the percentage of the total project costs covered by grants to incentivize farmers to co-finance the project with their own funds and/or commercial financing. The more solar PV projects the financial institutions finance, the more experience they will have and the more willing they will be to increase access to finance on better terms and conditions.

For agro businesses, the seven partner banks and partner leasing company of KCGF can use the agro window to guarantee their loans for agriculture projects that could include a solar PV component. Commercial loans are available, but bank, MFI, and lease funding of solar PV for such installations has been limited to date.

### **HOUSEHOLDS**

For lending to individuals (retail/consumer), including for households, banks and MFIs can lend based on the individual's regular source of income (for example salary from a job) and collateral (vehicles, house/apartment, etc.). The size of these installations is typically between 3-7 kW. The banks and MFIs surveyed by the KESS team (referenced in earlier sections) are all potential lenders and have

---

<sup>23</sup> Solar PV installations might be included within larger agriculture projects financed by the banks and MFIs where the solar PV is only one element of the overall project; for example, a greenhouse project which includes solar PV installed to generate electricity. Loans for such projects may not be identified or classified as a loan for a solar PV project.

experience with this sector. Retail loans for households for installing PV projects are based on evidence of other sources of income. For example, Raiffeisen Bank finances 70% of the project costs up to 30,000 EUR for a solar PV installation with a loan tenor of up to 180 months. The average interest rate is 3.99 % (each case is evaluated individually and priced), and the loan is secured by the person's salary and the solar equipment. The offer of such long tenor loans by banks will improve the affordability of installing solar PV.<sup>24</sup>

As experience of local banks grows, it is expected that banks will finance projects based on the projected savings in energy costs to cover debt service and use the solar panels as collateral. As the costs of solar PV projects reduce, and electricity tariffs increase, household solar PV projects will become financially more feasible and banks could finance the projects based more on cost savings than on household income.

Kosovo could incentivize household solar PV installations by exempting VAT for such projects. This would decrease the project cost by about one fifth and make household solar more affordable and financeable.

A potential source of external finance for households is the EBRD Green Economy Finance Facility (GEFF), which is currently run through the bank TEB, and the MFIs AfK and KRK. To improve energy efficiency and promote renewable energy, participating MFIs provide loans of up to 25,000 EUR and the bank provides loans of up to 50,000 EUR for households and up to 300,000 EUR for apartment buildings. These loans include a 15% grant component for one energy efficiency/RES measure and a 20% grant component for two or more energy efficiency/RES measures in households.<sup>25</sup> Banks have indicated that the GEFF facility could be used for financing household solar PV projects. Two additional banks have preliminary approval for joining GEFF and are expected to become active partner banks in Quarter I of fiscal year 2021.

## BUSINESSES

For businesses, banks and MFIs can provide loans for solar PV installations. Nine banks, at least four MFIs, and a leasing company are potential lenders for this purpose. The seven banks and one leasing company that are partners of KCGF can utilize the guarantees, and KCGF can provide up to a 50% guarantee (or up to 250,000 EUR) on loans of up to 1.0 million EUR from the partner financial institutions. KCGF is receiving additional capital under the newly approved Law on Economic Recovery, which will allow, on a short-term basis, to increase the guarantee up to 80% to help in recovery from the COVID-19 crisis (The Law on the Budget for 2021 was passed, so implementation of the additional capital can proceed).

The EBRD Kosovo SME Competitiveness Support Programme, which is currently run through ProCredit Bank and BPB, can provide loans to businesses for solar PV installations up to 1.0 million

---

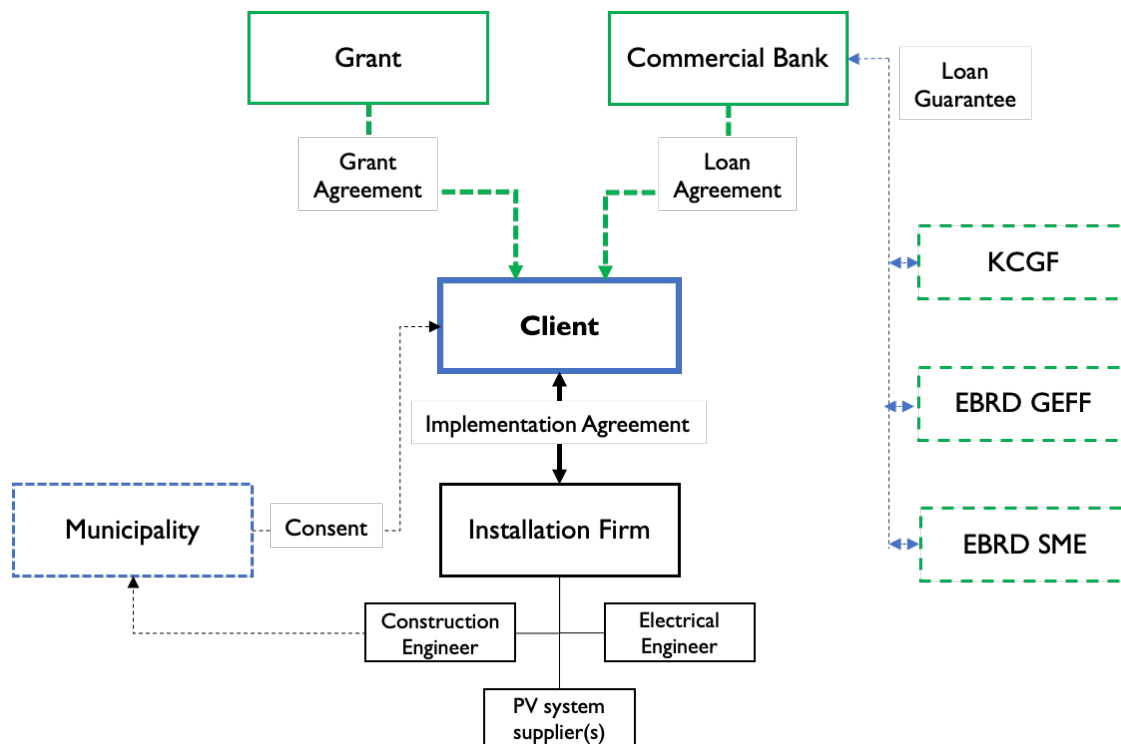
<sup>24</sup> For comparative purposes, household solar PV in the U.S. can currently be financed at interest rates of 1.9 – 2.9% with tenor of 20-25 years. The project/installation costs are higher in the US, but the electricity tariff is also higher. The very long tenors at low interest rates help make solar PV more affordable.

<sup>25</sup> <https://ebrdgeff.com/kosovo/grant-support/>.

EUR, with a 15% grant component.<sup>26</sup> It is expected that one to two additional banks will join the program in Q1, 2021.

### FINANCIAL MODELING OF BEHIND-THE-METER PROJECTS

The schematic of a behind-the-meter installation is shown below (Figure 5). The cost of the installation is offset by the energy generated by the project and the resultant savings from having to purchase less electricity from the grid. The energy produced is for self-consumption. The customer may be connected to the grid to buy electricity to cover shortfalls, such as at night or on especially cloudy days. However, it does not have net energy metering and does not sell any electricity to the grid.



**Figure 5: Schematic of a Typical Behind-the-Meter Installation**

A financial model was developed to analyze the financial feasibility of behind-the-meter solar PV projects for households and businesses. Financial analysis on three representative installations included:

- Case 1 – A household with 5kW capacity installation
- Case 2 – A private business with 50 kW capacity installation
- Case 3 – A private business with 400 kW capacity installation

The results of the analysis for each case along with the assumptions, sensitivity analysis, and financial feasibility of the projects are provided below.

<sup>26</sup> <https://web-sme-csp.com/kosovo/en/partner-banks/>.

### Case 1 – A Household with 5kW Capacity Installation

Variable	Unit	Assumption
Capacity solar PV installation	kW	5
Energy production factor	kWh/kW	1,350
Annual production self-consumed	%	100
Electricity tariff paid to the electricity company for electricity	EUR cents/kWh	0.0675
Total project cost factor	EUR/kW	900 - 1600
Total Project Cost	EUR	4,500 - 8,000
Percentage debt financing of total project cost	%	60 - 80
Interest rate	%	3 - 10
Tenor (years)	Years	5 - 10
Annual operating costs % of total project costs	%	0.5
Useful lifetime of solar panels	Years	20
Expected decrease in annual production efficiency of panels	%	0.25
WACC	%	10
Corporate tax rate	%	0

The financial model was run for a range of assumptions indicated above, with the electricity price of 0.0675 EUR/kWh. The IRR for the project ranged between 1% and 17% with coverage of debt service and operational expenses ranging from 41% to 123% over the tenor of the loan. The higher the percentage of debt coverage and operational expenses covered by the energy savings, the lower the risk of the financing and the less additional collateral or income required. Analysis of a scenario based on installation cost of 1,200 EUR/kW, with 60% of the project costs financed with a loan at 3% interest rate and 12-year tenure resulted in a 4% IRR and 117% coverage of debt service and operational costs from the energy savings. A debt equity ratio of 70% is reasonable in the market, as is interest rates in the range of 3% to 5%. Also, at least in some cases, tenors of up to 15 years are available. The project cost has a major impact on the IRR and debt/expense coverage. Grants of 15 – 20% and/or exemption from VAT would catalyze the uptake of solar for this category. Solar installers in Kosovo have proposed an exemption from VAT for household solar installations. The total project costs for households are considerably higher per kW production capacity than for larger projects, which reduces affordability and bankability of the projects. An exemption of the VAT on household installations would increase the affordability and facilitate an increase in household utilization of solar PV.

### Case 2 – A Private Business with 50 kW Capacity Installation

Variable	Unit	Assumption
----------	------	------------

Capacity solar PV installation	kW	50
Energy production factor	kWh/kW	1,350
Annual production self-consumed	%	100
Electricity tariff paid to the electricity company for electricity	EUR cents/kWh	0.1071
Total project cost factor	EUR/kW	700 - 900
Total Project Cost	EUR	35,000 - 45,000
Percentage debt financing of total project cost	%	60 - 80
Interest rate	%	3 - 10
Tenor (years)	Years	5 - 10
Annual operating costs % of total project costs	%	1
Useful lifetime of solar panels	Years	20
Expected decrease in annual production efficiency of panels	%	0.25
WACC	%	10
Corporate tax rate	%	10

The financial model was run for a range of assumptions indicated above, with the electricity price of 0.1071 EUR/kWh. The IRR for the project ranged between 7% and 23% with coverage of debt service and operational expenses ranging between 72% and 154% over the tenor of the loan. Analysis of a scenario based on installation cost of 800 EUR/kW with 70% of the project costs financed with a loan at 7% interest rate and 8-year tenor resulted in a 21% IRR and 148% coverage of debt service and operational costs from the energy savings. These terms and conditions are quite reasonable on the market now. Financial feasibility would improve with more favorable terms (lower interest rates with longer tenors) which may be possible depending on the history and track record of the business, its future prospects, and additional secondary collateral. Grants of about 15%, guarantees from KCGF, can all be helpful in facilitating update in this category.



### Case 3 – A private business with 400 kW capacity installation

Variable	Unit	Assumption
Capacity solar PV installation	kW	400
Energy production factor	kWh/kW	1,350
Annual production self-consumed	%	100
Electricity tariff paid to the electricity company for electricity	EUR cents/kWh	0.1071
Total project cost factor	EUR/kW	550 - 850
Total Project Cost	EUR	220,000 - 340,000
Percentage debt financing of total project cost	%	60 - 80
Interest rate	%	3 - 10
Tenor (years)	Years	5 - 10
Annual operating costs % of total project costs	%	1
Useful lifetime of solar panels	Years	20
Expected decrease in annual production efficiency of panels	%	0.25
WACC	%	10
Corporate tax rate	%	10

The financial model was run for a range of assumptions indicated above, with the electricity price of 0.1071 EUR/kWh. The IRR for the project ranged between 8% and 39% with coverage of debt service and operational expenses ranging between 76% and 199% over the tenor of the loan. An analysis of a scenario based on an installation cost of 700 EUR/kW total project cost with 70% of the project costs financed with a loan at 7% interest rate and 8-year tenor resulted in a 26% IRR and 170% coverage of debt service and operational costs from the energy savings. These terms and conditions are quite reasonable on the market now. Financial feasibility would improve with more favorable terms (lower interest rates with longer tenors) which may be possible depending on the history and track record of the business, its future prospects, and additional secondary collateral. Grants of about 15%, guarantees from KCGF, can all be helpful in facilitating update in this category.

#### SUGGESTIONS TO INCENTIVIZE BEHIND-THE-METER INSTALLATIONS

Solar installers in Kosovo have proposed an exemption from VAT for household solar installations. The total project costs for households are considerably higher per kW production capacity than for larger projects, which reduces affordability and bankability of the projects. An exemption of the VAT on household installations would increase the affordability and facilitate an increase in household utilization of solar PV.

It would be helpful to develop financial instruments that provide longer tenor loans to the solar PV sector and utilize the solar PV equipment itself as the sole or major collateral for the financing. Current solar PV technology has a useful lifetime of 20-25 years, but loan tenors typically are a third of that period.

Obtaining municipal consent is often another major obstacle causing lengthy delays in project approvals for clients pursuing solar PV installations (or resulting in the projects never getting off the

ground). Standard procedures for efficient and simple municipal review and approval should be introduced in all Kosovo municipalities.

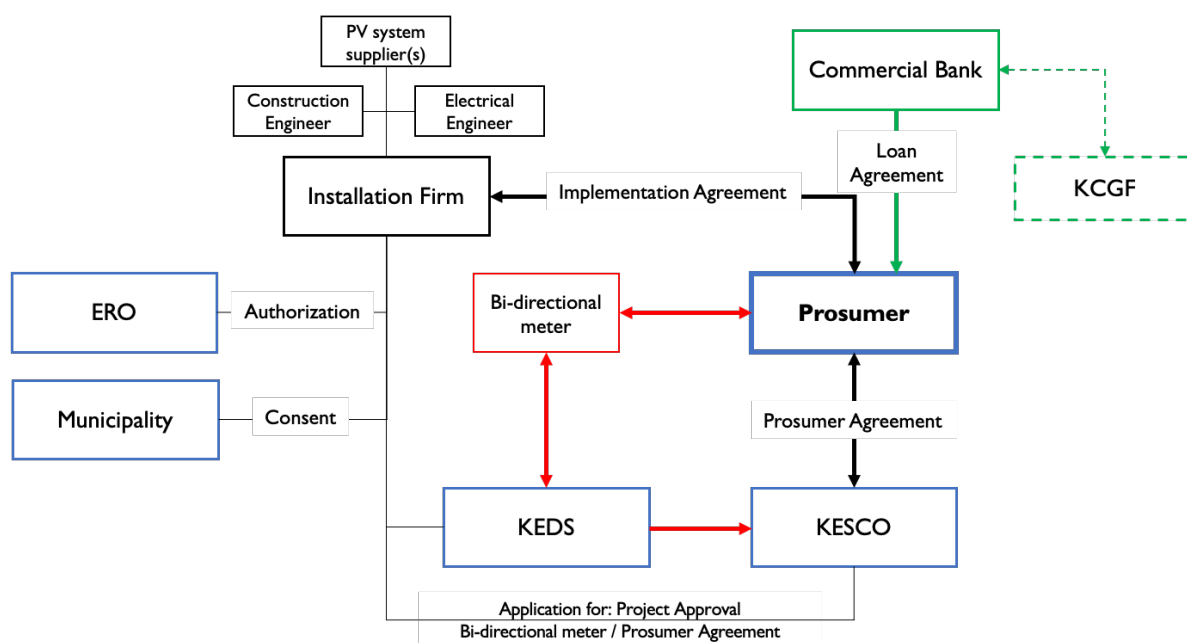
### PROSUMER INSTALLATION (SELF-CONSUMING GENERATORS UNDER SUPPORT SCHEME BASED ON NET-METERING)

Prosumers are currently the smallest solar PV market segment in Kosovo, totaling just 1.8 MW in installations. However, interest in this area continues to grow, thanks to the Prosumer Agreement which allows participants to sell excess energy back to the grid through net energy metering. Based on KESS assessment it is expected this will be fastest growing solar PV segment by 2030 with expected installed capacity of up to 250 MW, pending resolution of legislative barriers.

All local financial institutions including banks, MFIs and the leasing company could potentially finance prosumer projects. Household prosumer projects range from 3-7 kW in capacity, and funding is also available from the EBRD GEF program.

Business prosumer projects to date average about 63 kW. KCGF can support business prosumer solar PV installation with guarantees through participating financial institutions. The EBRD Kosovo SME Competitiveness Support Programme could also support business prosumer solar PV installations with loans from participating banks. In addition, other banks can and have financed business prosumer rooftop solar PV installations.

The schematic of a typical prosumer installation is shown below (Figure 6). Prosumers are connected to the grid with net energy metering and benefit from cost savings from self-generation and from revenues derived from electricity sales to the grid. These cost savings and revenues help offset the costs of the solar installation.



**Figure 6: Schematic of a Typical Prosumer Installation**

The three representative cases analyzed using the financial model for behind-the-meter installations apply for prosumers too. An option is to scale the capacity of the solar PV system to meet 100% of electricity needed for self-consumption selling excess power to the grid during the day and buying

power from the grid at night at lower tariffs. Revenues from selling excess power to the grid have not been taken into account in the model (any extra revenues reduce the risk).

### SUGGESTIONS TO INCENTIVIZE PROSUMER INSTALLATIONS

A constraint to prosumer installations is the capacity limit of 100 kW imposed by the ERO, which is too low for some businesses. For instance, in Albania, the limit is 500 kW. It is suggested that the ERO increase this limit from 100 kW to at least 500 kW. It is estimated with an increase in the ceiling, average capacity size of prosumer installations will increase to about 100-125 kW. It should be noted that in its recent Policy Guidelines, the Energy Community recommended that all prosumers with installations above 400 kW capacity should assume responsibility for balancing requirements.<sup>27</sup> It is likely that this will limit prosumer installations in most cases to a maximum of 400 kW.

Another drawback to prosumer installations is the onerous, lengthy application process to receive approval from the ERO, which can take a number of months. Municipal consent procedures contribute to the lengthy process, as does the time it takes to receive ERO authorization based on an engineer's certification that the roof can handle the load. It is suggested that the process be simplified and made much more efficient.<sup>28</sup>

An exemption from VAT for household prosumer installations would be beneficial in making the installations more affordable and bankable. Financial instruments that provide longer tenor loans to prosumers allowing them to utilize the solar PV equipment itself as the sole or major collateral for the financing would be helpful. Current solar PV technology has a useful lifetime of 20-25 years, but loan tenors typically are for a third of that period.

### AUTHORIZATION PROCEDURE (SUPPORT SCHEME BASED ON FEED-IN TARIFF AND REGULATED FRAMEWORK)

To date, six projects totaling 10 MW are operational in Kosovo through the Support Scheme. Each of these projects was contracted under the former FIT level of 136.4 EUR/MWh. All six projects are 3 MW size or less in capacity and have a 12-year PPA.

In 2019, the ERO extended the total capacity eligible for the Support Scheme by 20 MW but with a lower FIT of 85.5 EUR/MWh over a 12-year PPA. An additional eight project applications received Preliminary Authorization but are now suspended, and another 28 pending applications are in the Waiting List. However, in its most recent board meeting, the ERO decided to end the FIT support scheme. Approvals for the 20 MW of additional projects are pending a court decision.

The viability and bankability of these projects hinges on electricity sales to the grid and are heavily dependent on the pricing methodology applied in the absence of a FIT. Tariff variability over the life of the PPA will also significantly impact financing for such projects.

---

<sup>27</sup> Energy Community Secretariat. 2020. Policy Guidelines by the Energy Community Secretariat on Integration of Renewables Self-Consumers. PG 03/2020/28 September 2020. Energy Community Secretariat. Vienna.

<sup>28</sup> In many parts of the U.S. Prosumer client install the system, passes the inspection, apply directly to the energy supplier, and typically receives authorization for net energy metering within 10-15 business days.

## FINANCING OPTIONS FOR PROJECTS UNDER AUTHORIZATION PROCEDURE

Commercial banks in Kosovo could potentially finance projects under the Authorized Procedure and benefit from loan guarantees offered through KCGF for participating banks as described earlier. KCGF is developing a new guarantee window for energy efficiency and renewable energy, which is projected to provide a 50% guarantee on loans up to 2.5 million EUR (with guarantee amount up to 1.25 million EUR) and total project costs up to about 3.5 million EUR<sup>29</sup>. This limits projects that KCGF can guarantee to approximately 3 MW in capacity. It is hoped that this new window will become operational sometime in 2021.

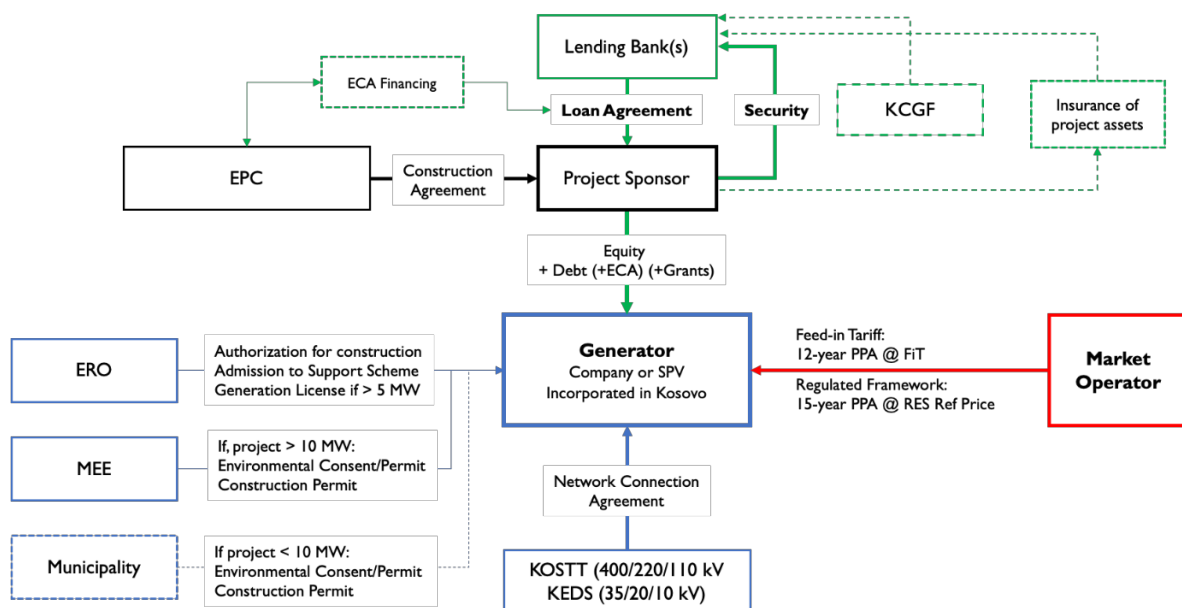
In addition, through a project supported by the Millennium Challenge Corporation (MCC)/MFK, KCGF is planning to increase the capacity of bankers, KCGF personnel and consultants in project and energy finance in Kosovo and to develop a standardized template solar PV project document package for developers to use as part of their loan applications to banks and leasing institutions. This package would include all requirements for the solar PV project including technical, environmental, regulatory, licensing, and financial documentation. With or without a guarantee from KCGF, the banks have stated that they would be more likely to seriously consider financing these projects if they received the applications in a standardized, recognizable format that contained all the necessary information.

While banks have experience undertaking due diligence of their clients, lending based on project finance will require guarantees against PPA payments, project termination, and political risk, similar to the challenges for financing large solar PV projects described earlier.

The schematic of a typical project developed under the Authorization Procedure is shown below (Figure 7). All electricity generated less a small fraction for self-consumption is sold to the grid.

---

<sup>29</sup> Based on interviews with KCGF management and information on the KCGF website.



**Figure 7: Schematic of a Typical Project under the Authorization Scheme**

A financial model was used to analyze the financial feasibility of typical projects under the Authorization Scheme based on assumptions provided below.

**Table 4: Case 4 – A private business with 3,000 kW capacity installation**

Variable	Unit	Assumption
Capacity solar PV installation	kW	3,000
Energy production factor	kWh/kW	1,350
Annual production self-consumed	%	99
Electricity tariff paid to the electricity company for electricity	EUR cents/kWh	0.045 – 0.085
Total project cost factor	EUR/kW	550 - 850
Total Project Cost	EUR	1,650,000 – 2,550,000
Percentage debt financing of total project cost	%	60 - 80
Interest rate	%	3 - 7
Tenor (years)	Years	10 - 15
Annual operating costs % of total project costs	%	1
Useful lifetime of solar panels	Years	20
Expected decrease in annual production efficiency of panels	%	0.25
WACC	%	10
Corporate tax rate	%	10

The financial model was run for a range of assumptions indicated above. The IRR for a typical project ranged between -2% and 56% with coverage of debt service and operational expenses ranging between 72% and 291% over the tenor of the loan. An analysis based on project costs of 550 EUR/kW with 70% debt at 5% interest rate over a 12-year tenor, and an energy price of 0.045 EUR cents/kWh,

resulted in an IRR of 8% with a 126% coverage of debt service and operational costs from revenues. The IRR and debt coverage are sensitive to project costs, debt terms and electricity price. The duration of the PPA, certainty of the energy price over the tenor of the PPA, and instruments to mitigate risks would also be critical.

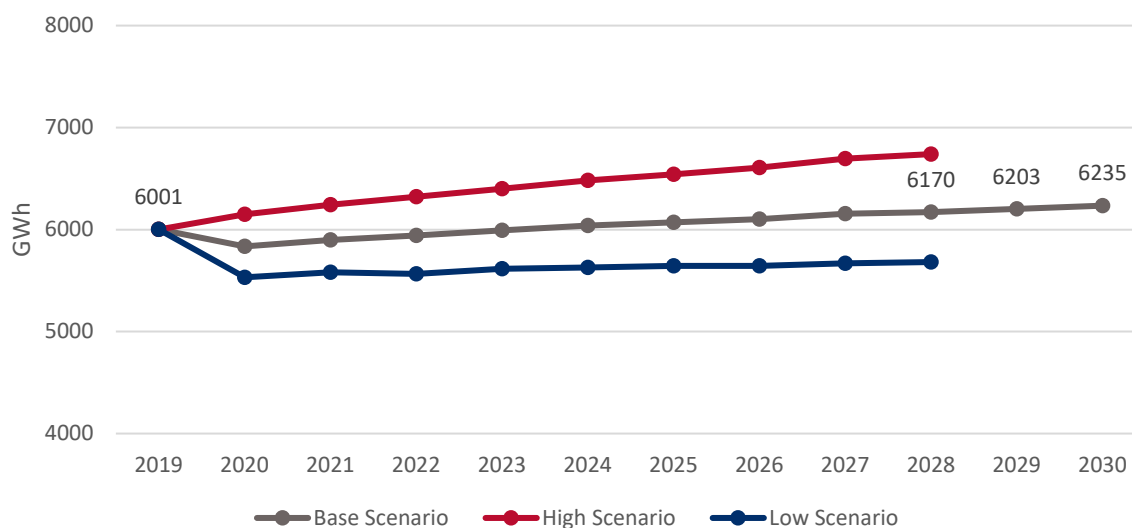
#### **SUGGESTIONS TO INCENTIVIZE PROJECTS UNDER THE AUTHORIZATION PROCEDURE**

The biggest current impediment to increasing the installation of solar PV farms/PPAs in the range of 1 to 5 MW is the uncertainty on the mechanism for establishing the energy price. The ERO board has decided to discontinue the FIT and is considering a reference price or tender price that is subject to change from year to year. Certainty in the pricing mechanism will be crucial to additional projects being developed under the Authorization Scheme.

Prospective lenders need a strong, enforceable, and aligned set of project documents (PPA, Implementation Agreement, and Grid Connection Agreement) to ensure repayment of the financing. They will want a long term, enforceable commitment to the energy price. Ideally these project documents are standardized to help make the project review process for prospective lenders more efficient. An Implementation Agreement signed off by the Ministry of Finance would give more assurance to investors and lenders about political risk, retroactive changes to relevant taxation and price agreements, and other government risks associated with grid-connected power projects.

## KOSOVO ELECTRICITY DEMAND FORECAST 2030

The following section looks at Kosovo electricity demand forecasts presented in various official documents to determine the share of solar PV projects pipeline in the electricity consumption by 2030. The presented demand forecast in Figure 8 below is based on analysis of forecasts presented in the Kosovo Energy Strategy (2017 – 2026), KOSTT Long Term Energy Balance (2019 – 2028) and linear extrapolation for years 2029 and 2030 based on Base Scenario<sup>30</sup>.



**Figure 8: Energy Demand Forecast 2020 - 2030**

### ENERGY STRATEGY (2017-2026)

The Energy Strategy of Kosovo 2017-2026, sets out the basic objectives of the Government of Kosovo in energy sector development, taking into account sustainable economic development, environmental protection, sustainable and reliable energy supply to final customers, efficient use of energy, development of new conventional and renewable generation capacities, creation of a competitive market, development of the gas system, and creation of new jobs in the energy sector. The current version of Kosovo Energy Strategy is being revised, and the new version will reflect recent developments in the energy sector in Kosovo, recommendations from NECP, and will take into account recent as well as future developments in terms of RES generation capacities in Kosovo.

With regards to the electricity energy demand, the projections are part of Annex 2 of the Strategy, however, the projection only covers the period through 2026. The projection of electricity demand was done based on four consumption scenarios:

- Real growth of GDP;
- Low scenario (1);
- Basic scenario (2); and,
- High scenario (3).

<sup>30</sup> The Base Scenario was approved by GoK in Energy Strategy 2017 – 2026.

Projections of economic growth are based on the Economic Reform Program as presented in Table 5 below.

**Table 5: Projections of Economic Growth According to the Document: Economic Reform Program<sup>31</sup>**

SCENARIO	Proj.	Proj.	Proj.	Proj.	Proj.
Real growth of GDP	2016	2017	2018	2019	2020-2025
Low scenario (1)	1.1	2.5	2.2	2.2	2.2
Basic scenario (2)	4	4.3	4.3	4.3	4.3
High scenario (3)	4.5	6.2	5.4	5.4	5.4
<b>Actual (for comparison)<sup>32</sup></b>	4.06	4.1	3.8	4.1	-2.1 (2020 proj.)

## SCENARIOS FORECASTING ELECTRICITY DEMAND

The Kosovo Energy Strategy 2017-2026 presents four different electricity demand scenarios as presented in Table 6 and Figure 9.

**Table 6: Summary of Scenarios of Electricity Demand of Electric System<sup>33</sup>**

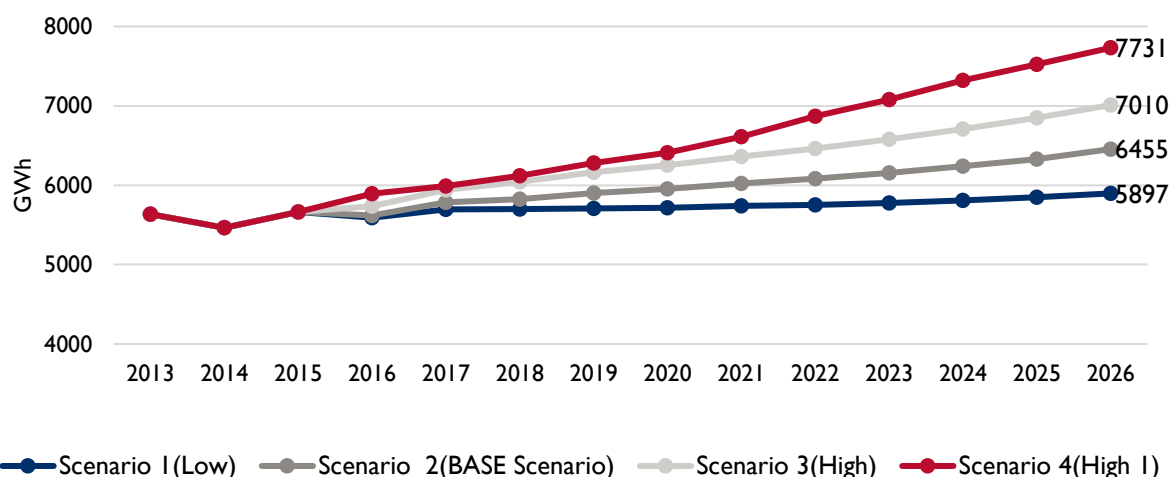
Gross total consumption (GWh)	2017	2018	2019	2020	2021	2022	2023	2024	2025	2026
Scenario 1	5694	5700	5706	5715	5741	5751	5776	5809	5849	5897
Scenario 2	5784	5826	5902	5955	6024	6084	6156	6238	6330	6455
Scenario 3	5942	6041	6164	6253	6361	6461	6577	6706	6848	7010
Scenario 4	5990	6120	6280	6410	6610	6870	7080	7319	7522	7731
Actual	5685	5671	6001							

<sup>31</sup> Source: Annex 2 of the Energy Strategy (2017-2026).

<sup>32</sup> Source: MEE website.

<sup>33</sup> Source: Annex 2 of the Energy Strategy (2017-2026).





**Figure 9: Electricity Demand Scenarios<sup>34</sup>**

The most realistic scenario for electricity demand accepted for the Energy Strategy 2017 – 2026 is Scenario 2 (Basic scenario) that is presented in Table 7 and Table 8 that also includes losses.

**Table 7: Demand for Electricity Based on Scenario 2 of Electricity Final Consumption<sup>35</sup>**

Consumption by type of consumers (GWh)	2016	2017	2018	2019	2020	2021	2022	2023	2024	2025	2026
220KV	608	634	661	689	719	750	782	816	851	888	888
110 KV	91	95	99	103	108	112	117	122	127	133	133
<b>Total 220KV&amp;110KV</b>	<b>699</b>	<b>729</b>	<b>760</b>	<b>793</b>	<b>827</b>	<b>862</b>	<b>899</b>	<b>938</b>	<b>978</b>	<b>1020</b>	<b>1021</b>
Industry (35KV,10KV)	273	285	297	310	323	337	352	367	383	399	399
Service sector	832	861	891	921	953	986	1020	1055	1091	1129	1129
Household sector	2171	2208	2245	2286	2329	2375	2410	2446	2483	2520	2522
Consumption in distribution	3277	3354	3433	3517	3606	3698	3782	3868	3957	4048	4050

Following the inclusion of the impact of losses and other measures in electricity demand, the gross demand will be as outlined in Table 8:

**Table 8: Demand for Gross Electricity Based on Scenario 2 of Electricity Consumption<sup>36</sup>**

Gross total consumption (GWh)	2016	2017	2018	2019	2020	2021	2022	2023	2024	2025	2026
<b>(Basic scenario)</b>	<b>5802</b>	<b>5784</b>	<b>5826</b>	<b>5902</b>	<b>5955</b>	<b>6024</b>	<b>6084</b>	<b>6156</b>	<b>6238</b>	<b>6330</b>	<b>6455</b>

<sup>34</sup> Source: Annex 2 of the Energy Strategy (2017-2026).

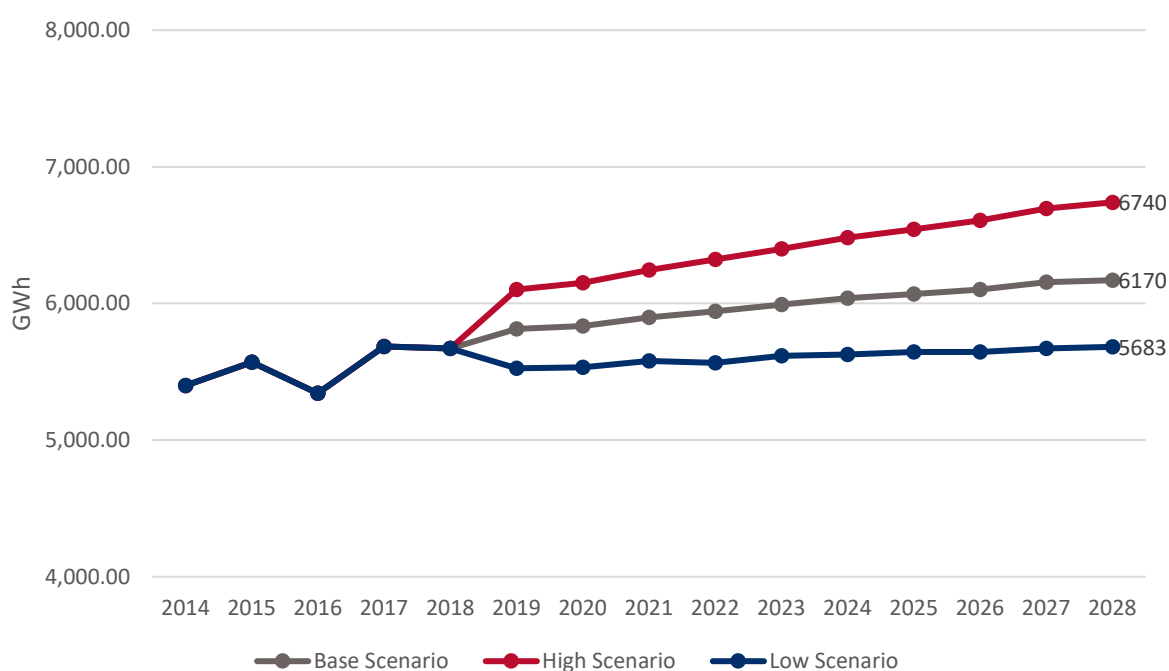
<sup>35</sup> Source: Annex 2 of the Energy Strategy (2017-2026).

<sup>36</sup> Source: Annex 2 of the Energy Strategy (2017-2026).

## LONG TERM ENERGY BALANCE (2019 – 2028)

The Long-Term Energy Balance 2019-2028 was developed by KOSTT and approved by ERO. The 10-year balance revision takes place every two years. This document is compiled according to the rule ERO / No.16 / 2018, which describes the Rule and methodology for the preparation of Energy Balances, the requirements for the data they must contain, the deadlines and the procedures for their drafting and approval.

Figure 10 below shows the forecast scenarios for low, medium, and high growth of gross electricity demand for the period 2019-2028, including the current year and the energy consumed in the past three years, which are determined by the mathematical forecast model. The baseline scenario is projected with an average (arithmetic) increase of 0.57%, the high scenario with an average increase of 1.16% and the low scenario with an average increase of about 0.03%.



**Figure 10: Scenario of Low, Medium (base) and High Growth of Gross Electricity Demand<sup>37</sup>**

In addition, Table 9 below shows a summary of numerical values of demand forecast and maximum load for the time period 2019-2028. It should be noted that the values presented reflect gross national consumption.

The national consumption also includes the consumption of generation from the transmission network as well as the consumption at the distribution level supplied by the production of generators connected to the distribution network.

<sup>37</sup> Source: Long Term Energy Balance (2019-2028).

**Table 9: Numerical Data of the Scenarios of the Gross National Demand for Electricity<sup>38</sup>**

Gross Demand Scenarios		2019	2020	2021	2022	2023	2024	2025	2026	2027	2028
Base Scenario	GWh	5814	5835	5898	5943	5991	6039	6070	6102	6156	6170
High Scenario	GWh	6101	6150	6245	6322	6400	6482	6543	6607	6695	6740
Low Scenario	GWh	5526	5532	5580	5565	5616	5627	5644	5644	5670	5683

## KOSOVO RES TARGETS 2030

RES are now considered a cornerstone of future power generation not only for the EU Member States and for the Contracting Parties of the Energy Community who are continuously adopting new schemes for accommodating new RES targets requirements.

The related EU Directive (2018/2001) requires EU member states to achieve 32% of the final consumption of energy based on RES by 2030. The previous EU Directive (2009/28/EU) had set a binding target of 20% as a final energy consumption to be reached by 2020 from renewable sources. In accordance with that, the EU countries and Contracting Parties of the Energy Community adopted their relevant National Renewable Energy Action Plans (NREAP's) as part of their overall commitment in meeting national targets for 2020. Kosovo adopted its NREAP in 2013.

RES represents an important, yet still largely untapped, energy source in Kosovo. Greater utilization of RES will help Kosovo achieve the following three objectives:

- Support for overall economic development,
- Increase of the security of energy supply, and
- Protection of the environment.

The energy sector laws, especially the Law on Energy, describe the promotion, optimization, and use, including determination of annual and long-term goals of energy generation from RES. To promote the use of RES, the Ministry of Economic Development drafted a ten-year action plan for RES for the period 2011-2020, in line with the obligations from the Energy Community Treaty (ECT).

Kosovo initially committed to a binding target of 25% of energy from renewable sources in gross final energy consumption by 2020 compared with 18.9% in 2009. However, in 2013, Kosovo adopted another “voluntary target” of 29.89% by 2020.

<sup>38</sup> Source: Long Term Energy Balance 2019-2028.

Based on the EUROSTAT Report, Kosovo achieved 24.89 % of energy from RES in gross final energy consumption in 2019. Therefore, it appears that Kosovo will achieve a target of 25% by the end of 2020.

Based on ERO Annual Report (2019), Kosovo's overall share of energy from renewable sources was 24.89%. The utilization breakdown of these renewable sources included:

- RES Electricity: 5.1% (Share of energy from renewable sources in gross electricity consumption)<sup>39</sup>
- RES Heating and Cooling: 58.13% (Share of energy from renewable sources for heating and cooling).

The contribution of solar PV is still small (0.04%). The above numbers on the overall share of RES in gross final energy consumption, are somewhat misleading, because much of the achievement attributed to reaching renewable energy sources target is done by counting woody biomass for heating rather than actual investments in different RES technologies.

## **DRAFT NATIONAL ENERGY & CLIMATE PLAN (NECP) OF KOSOVO**

Kosovo's continued efforts in meeting the requirements arising from the ECT are now culminating with the creation of the NECP. While the NECP will become legally binding for EU Members States and neighboring countries, the Contracting Parties of the Energy Community are recommended to develop NECPs under the Recommendation of the Council of Ministers of the EnC 2018/01/MCEnC, as part of their ultimate objective of creating an integrated pan-European energy market.

Kosovo's NECP is being drafted and its finalization for public discussion and availability for stakeholders is expected in early 2021. According to the information received from the MEE, the majority of policy measures and projections through 2030 have been already defined and the experts are now modeling the input data received by the relevant institutional bodies. According to the discussions with responsible staff of the MEE regarding the NECP, it was understood that the NECP envisages three supply scenarios, which can be the subject of analysis once the document is launched for discussion.

Similarly, the MEE noted that the NECP will conclude that Kosovo agrees to contribute to the 32% EU-wide target of renewable sources for the gross final energy consumption by 2030. Therefore, the planned RES targets in gross final energy consumption in 2030 is foreseen in the level of 30.15%. In relation to the share of RES in the final electricity consumption, the document foresees in total 28.9% of electricity from RES by 2030. Further, Draft NECP foresees that the installed capacity of solar PV by 2030 will reach 310 MW.

## **PV GENERATION SHARE IN ACHIEVING 2030 TARGETS**

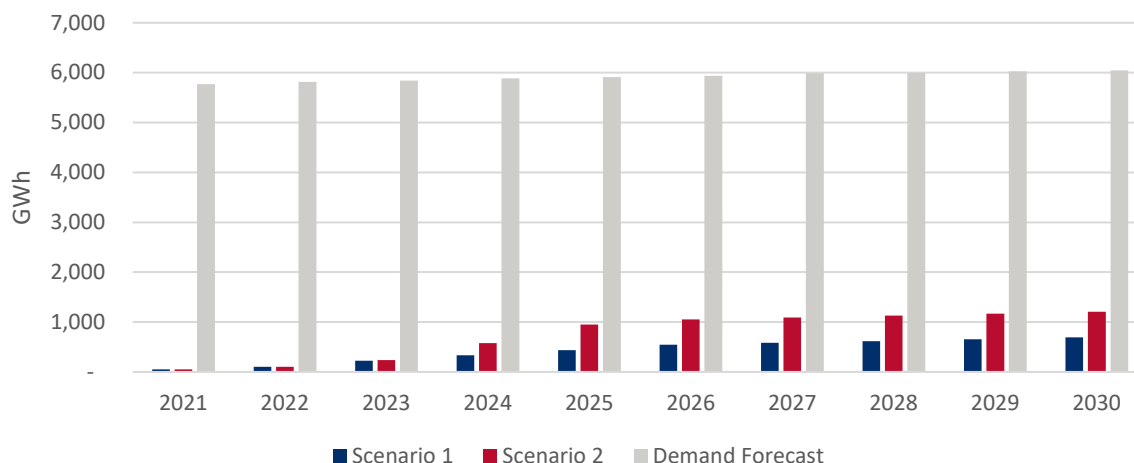
Based on electricity demand forecast 2021 - 2030, the 310 MW new solar PV capacity as planned under NECP would meet approximately 6.7% of electricity demand by 2030.

---

<sup>39</sup> ERO Annual Report 2019

The development of projects envisaged under the PV project pipeline is presented in two scenarios (Figure 11) and their respective share in gross electricity demand:

- Scenario 1: Projects with high likelihood of implementation, meeting 11% of the gross electricity demand in 2030; and,
- Scenario 2 – All projects, including Private Sector Initiatives based on Law on Strategic Investments, meeting 19.2% of the gross electricity demand in 2030.



**Figure 11: Solar PV Project Pipeline Scenarios in Meeting Gross Electricity Demand**

## GRID INTEGRATION & ENERGY MARKET

### GRID INTEGRATION

The EU's Clean Energy for all Europeans Package (CEP) aims to improve decarbonization of the energy sector and implement greenhouse gas emissions reduction commitments in line with the Paris Agreement. The CEP promotes the opportunity to final customers for their active participation in the energy market, with emphasis to enable them to generate, consume, store, and sell self-generated electricity.

Under the CEP the DIRECTIVE (EU) 2019/944 on Common Rules for the Internal Market sets out modes for Members States, regulatory authorities, and transmission system operators to cooperate towards creation of a fully interconnected internal market for electricity that increases the integration of electricity from renewable sources, free competition, and security of supply. In addition, this directive describes the general objective of regulatory authorities for helping the parties to achieve the integration of large and small-scale production of electricity from distributed generation in both transmission and distribution networks, as well as to introduce network development plans for TSO and DSO to support integration of installations generating electricity from RES.

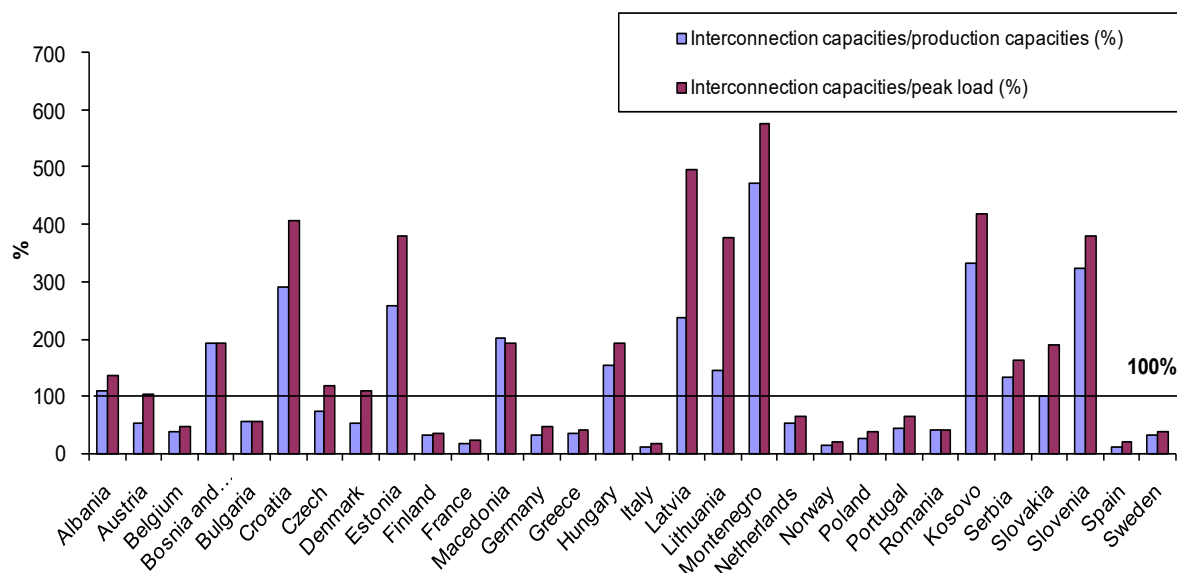
As stated in previous chapters, the new Renewable DIRECTIVE (EU) 2018/2001 on the promotion of the use of energy from renewable sources, obliges the EU Member States, among others, to put in place an enabling framework that promotes and facilitates the development of renewable self-consumption.

While the CEP is not yet a legally-binding package within the Contracting Parties of the Energy Community, preparations on its incorporation into the respective national legislations have already started. Thus, the Energy Community Secretariat has recently published the Policy Guidelines on Integration of Renewables to guide the Contracting Parties to establish a comprehensive and harmonized legislative framework to promote self-consumption.

The level of power system interconnectivity is one of the basic preconditions for electricity market development and RES integration. EU Member States as well as Contracting Parties of the ECT are aiming to reach the following targets by 2030 related to peak load and RES integration:

- Nominal transmission capacity of interconnectors below 30 % of peak load; and,
- Nominal transmission capacity of interconnectors below 30 % of installed renewable generation.

Kosovo possesses a highly developed transmission system and is among top three countries in Europe in both, the ratio between interconnection capacities and installed production capacities, as well as ratio between interconnection capacities and the peak load. Figure 12 below further describes the interconnection capacities of Kosovo in relation to other EU Member States.



**Figure 12: Interconnection capacities of European countries<sup>40</sup>**

Furthermore, the electricity transmission network of Kosovo is very well connected with neighboring countries as shown in the table below:

**Table 10: Development of Installed Interconnection Capacity and System Peak Load in High Scenario<sup>41</sup>**

Interconnection lines	Voltage Level	Installed capacity	Net Transfer Capability level (NTC)
Kosovo – Albania	400 kV	1,317 MVA	600 MW

<sup>40</sup> Power Point Presentation, Transmission Projects in Western Balkans Region, Vienna October 2012

<sup>41</sup> Source: Energy Strategy of Kosovo 2017 – 2026.

	220 kV	300 MVA	
<b>Kosovo - Montenegro</b>	400 kV	1,317 MVA	400 MW
<b>Kosovo – Serbia</b>	400 kV	1,317 MVA	600 MW
	220 kV	300 MVA	
<b>Kosovo - North Macedonia</b>	400 kV	1,317 MVA	400 MW

The total Net Interconnection Transmission Capacity of Kosovo with neighboring countries is 2,000 MW. This capacity is several times higher than the level of power system interconnectivity aimed for 2030 and for any projections by 2050.

## RES INTEGRATION TO THE TRANSMISSION NETWORK

The installed transmission capacity of interconnectors of TSO is more than sufficient to accept high development of RES by 2030. The table below shows the capabilities of transmission system to accommodate very high capacities of generation from RES.

**Table 11: Development of Installed Interconnection Capacity and RES Projects Development<sup>42</sup>**

	Year 2020	Year 2025	Year 2030
<b>Capacities of renewable generation in High Scenario (MW)</b>	272	438	470
<b>Total installed interconnection capacity (MW)</b>	5,575	5,575	5,575

Furthermore, the investments in transmission infrastructure in the last decade have resulted in an efficient, reliable, and highly secure transmission network. This development has created favorable conditions to support the integration of renewable sources in the transmission system. Considering capacities that Kosovo has in renewable sources, the connection of such generators is mainly expected to occur in the 110 kV network which is quite well developed and distributed throughout the territory of Kosovo.

Additionally, recent years noted a significant interest for solar sources (PV) by investors who are interested to develop projects of large capacities that will be connected in the transmission network. Therefore, KOSTT has prepared the Network Code – Connection Code<sup>43</sup>, which under Section 8 determines technical criteria that must be fulfilled by applicants for this type of RES.

As presented in the KOSTT's latest development plan 2021 – 2030, which is currently on public discussion, a large number of applications for the construction of wind and solar energy parks have applied for connection to the transmission network. Until September 2020, KOSTT has accepted a number of applications that are presented in Table 12 below:

**Table 12: Applications for RES projects in KOSTT<sup>44</sup>**

RES Power Plants	Technology	Capacity (MW)
------------------	------------	---------------

<sup>42</sup> Source: Energy Strategy of Kosovo 2017 – 2026.

<sup>43</sup> <https://www.kostt.com/Content/ViewFiles/TechnicalCodes/KRRKK.pdf>.

<sup>44</sup> Source: Draft KOSTT Development Plan (2021 – 2030).

Koznica	Wind	34.5
Budakova	Wind	46
Zatriqi	Wind	64.8
Kamenica	Wind	100
Çiçavica	Wind	116
Mareci	Wind	31.2
Kitka (extension of capacity)	Wind	20
Bejta Comerc	Solar	9
Sferka Solar	Solar	21
Energy Bio Ranch	Solar	9
SEGE	Solar	150

Favorable factors for RES Integration into the Transmission System include:

- Reliable and secured transmission network,
- Priority dispatch,
- KOSTT manages RES Fund through Market Operator,
- Feed-in Tariffs, and
- Market integration with Albania and further integration in regional market.

Constrain factors for RES Integration into the Transmission System include:

- Lack of power reserves,
- Inflexible existing TPP units, their age and technical condition, and
- No energy storage facilities or flexible units such a pump storage unit.

Although the transmission network has sufficient capacities to integrate renewable sources, the problem for the System Operator remains the increase of systems regulatory reserve requirements, with particular emphasis on secondary and tertiary control reserves, due to the variable and highly unpredictable wind and solar sources. This difficulty may be reduced by integrating small markets into an integrated regional market where access to ancillary services will be easier, and the level of regulatory reserves required will also be reduced. Therefore, the ongoing process of creating a common electricity market between Kosovo and Albania, and further integration into the regional market, will contribute to reducing the problem of RES integration to the system.

Another potential mitigation measure is introduction of **Utility Scale Battery Storage Systems** offering wide spectrum of system services as described in detail in Appendix I of this report.

## RES INTEGRATION TO DISTRIBUTION NETWORK (KEDS)

Despite the very well-developed transmission system, Kosovo has a modest distribution network that needs to be further improved to be able to integrate the planned increase of number of RES distribution generators, including self-generation/prosumers.

The draft development plan of Distribution System Operator (KEDS) 2019 – 2028, focuses on the reduction of losses and improving the quality of supply to customers. However, there is not any particular section in this development plan that particularly addresses the issue of integration of RES in the distribution system, apart from the plan for construction of a new Substation in Dragash aiming to integrate the increased number of Small Hydro Power Plants (SHPP) in that region.



Nevertheless, under the Southeast Distribution System Operators Security of Supply Working Group (SEE DSO WG), where KEDS is a member, a Position Paper<sup>45</sup> has been recently published, which gives emphasis on the technical challenges DSOs face in integrating increasing amounts of RES energy into their network. Some of the key findings of the mentioned paper can be listed as follows:

- The current DSOs of SEE countries are not designed for two-way electricity flow.
- The DSO network charges (tariffs) are based on the volume of electricity flow, therefore, with increased number of prosumers these charges will be lower.
- Net-metering scheme reduces the amount of funds for DSOs.
- The increased number of DG generators will have impact in technical and operational parameters of distribution network (voltage level, protection settings, balance etc.).
- Distribution Generators are not paying for the use of system charges.
- Increased number of integrations of DG to network requires provision of new network services and improved management of network.
- There is a need for completing the grid connection studies related to integration of DG to networks.
- The technical, operational and safety criteria for connection of DG to network should be clearly set and known for DG applicants.

In this position paper a recommendation for each of the findings are also presented. The biggest challenge for integration of DG to distribution network are the technical criteria for connection of the Distribution Generators to Distribution Network. Therefore, CIGRE on its technical brochure of WG C6.24, June 2014 on “Capacity of Distribution Feeders for Hosting Distributed Energy Resources (DER)”, has summarized the technical issues arising from connection of DER (DG) to the grid, such as:

- **Thermal ratings:** Connection of DER has the effect of changing current flows in the network, which may lead to violation of the loading levels of network elements (thermal rating), especially under maximum generation and minimum load conditions.
- **Voltage regulation:** Voltage regulation is primarily achieved through on-load tap changers (OLTC) controlled by automatic voltage control (AVC) schemes at the HV/MV substations, as well as by step voltage regulators (VR) installed along MV feeders. Switchable capacitor banks also contribute to this task. Concerns include the excessive tapping of OLTC and VR, which increases wear of the equipment and increases maintenance costs, the required extended range of regulation and the need for improved regulation algorithms.
- **Fault level:** Distribution networks are characterized by a design short circuit capacity, which corresponds to the maximum fault current that can be interrupted by the switchgear used and does not exceed the thermal and mechanical withstand capability of the equipment and standardized network constructions. Since DER contribute to the fault current, their interconnection may lead to exceeding the short circuit capacity of the network.
- **Power quality:** Besides the voltage regulation issues, DER installations may induce power quality disturbances, which mainly include fast voltage variations due to switching operations, including voltage dips and over-voltages, emission of harmonics and flicker. Disturbances depend very much on the type and technology of DER equipment, as well as on the

---

<sup>45</sup> <https://usea.org/sites/default/files/SEE%20DSO%20Position%20Paper%20-%20Final.pdf>

characteristics of the network and may impose limits to the hosting capacity of specific networks.

- **Other technical constraints:** Reversal of power flows in the network may have a negative effect on certain elements of the system.

Related to PV integration to Distribution Network, it is also important to mention the KOSTT project for installation of solar panels in the roofs of Sub-Stations (SS) facilities with total installed capacity of 1,000 kW. In this regard, KOSTT, in discussion with its international partners KfW, has ensured a grant covering the costs for this project.

Furthermore, there is an ongoing WB study in Kosovo entitled: “Energy Efficiency and Renewable Energy Project. Support for Grid Integrated Renewable Energy Generation.” This study is expected to define:

- The optimal investment needs for the distribution network of Kosovo, in order to accommodate the target RES capacity up to 2030;
- Technical criteria for RES integration;
- Methodology and cost for connection of Distribution Generators to the distribution system; and,
- Simplified process and procedures for becoming a Prosumer.

## ENERGY MARKET

Kosovo as a Signatory Party to the ECT has developed relevant policies, legal and regulatory frameworks to ensure the opening and functioning of the Energy Market. The legislation and regulatory frameworks in place are largely in compliance with the EU’s Third Energy Package, while there is now an imminent need to begin with necessary preparations in order to align the primary legislation with requirements arising from the most recent Fourth Energy Package, introduced as “Clean Energy for all Europeans”.

The energy market includes electricity and natural gas markets. Currently, Kosovo has neither the infrastructure developed for natural gas nor the related gas market, therefore, the information provided below is related merely to electricity market.

The electricity market in Kosovo includes bilateral electricity trading and trade to balance the electricity system. Based on the legislation in force, electricity producers are obliged to offer their capacity in a transparent, non-discriminatory, and market-based manner to all consumers in wholesale and retail markets, including those with public service obligations. All consumers at the market have a right to freely change their supplier.

Although the legal and regulatory framework in the energy sector has allowed gradual electricity market opening, there is still no competitive electricity retail market in Kosovo. To date, eight suppliers have been licensed including the supplier under the Public Service Obligation (KESCO) set by the Regulator to supply consumers with the right to get universal supply service. However, except KESCO, all other licensed suppliers are still inactive.

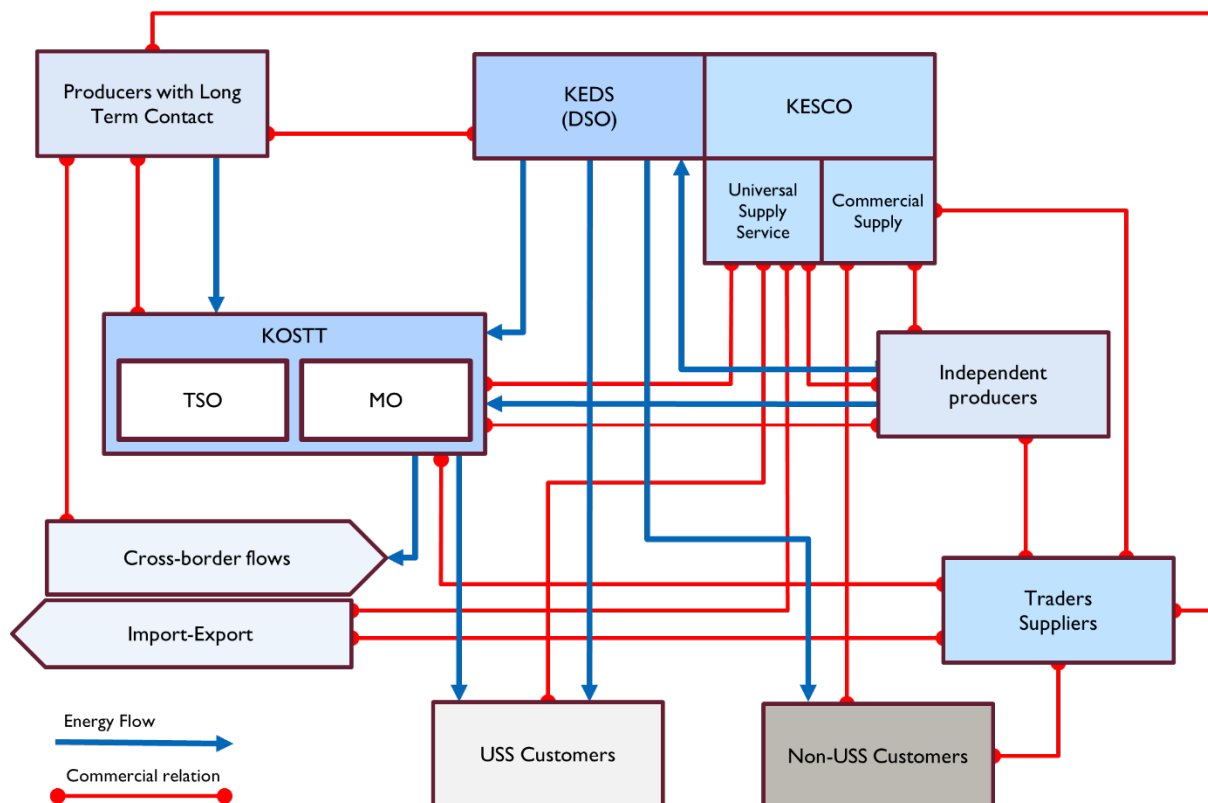
Kosovo is committed to open the market and to implement the EU’s Third Energy Package, hence, on January 2017 the ERO adopted the Guidelines for Electricity Market Liberalization.

The Electricity Market Liberalization Guidelines envisage gradual price deregulation for final consumers. Accordingly, customers connected to 220 kV and 110 kV are already supplied at deregulated prices, while customers connected to voltage 35 kV should be supplied with deregulated prices from March 31, 2020, and customers connected at voltage level 10 kV from March 31, 2021.

Wholesale electricity market in Kosovo is mostly based on bilateral contracts. KEK as a main electricity producer in Kosovo has a bulk supply agreement (BSA) with KESCO who is supplying regulated customers under the universal service obligation. This obligation is given to KESCO by the ERO. Under BSA, KEK should provide to KESCO the amount of electricity for supplying customers under the universal service obligation that is 70%-90% of all produced electricity from KEK. Although the price for this part of generation portfolio is bilateral, it can be considered as regulated given that it is set on the basis of historic regulated prices and based on an opinion by the Regulator. In addition, the current RES generators are under the support scheme (feed-in tariff), with only a 25% balancing responsibility and therefore offering no incentive for participation in the electricity market.

There is no platform for trading forward products for Kosovo’s market and thus no standardized contracts, products, or forward price signals.

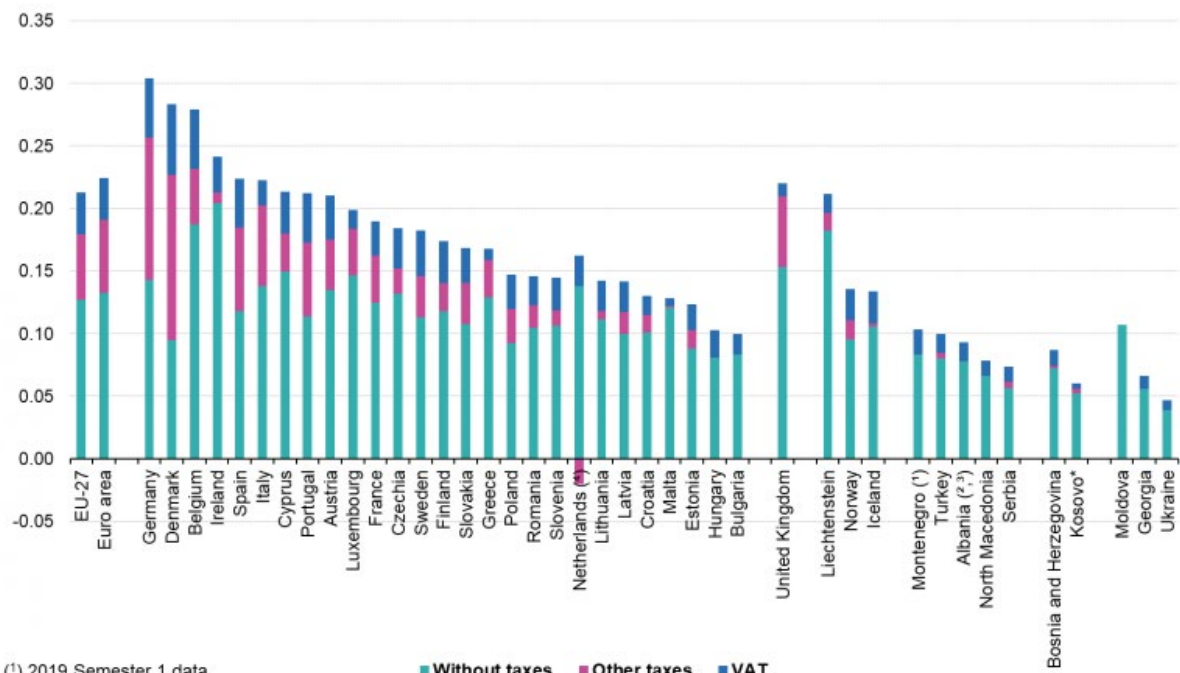
Furthermore, production prices for public generators are deregulated from April 1, 2017, but this electricity, as explained above, will be offered with priority for the Universal Supply Services Provider (regulated customers), while the share of the remaining energy will be transparently offered in the wholesale market in accordance with the "Energy Trading Procedure", "Market Rules" and "Market Design". In addition, for coverage of network losses, as well as for consumers with unregulated prices, the electricity may be purchased on the regional Day-Ahead markets (HUPLEX, SEEPEX, etc.) and/or in the form of bilateral contracts on the free market.



**Figure 13: Physical and Commercial Transfers in the Current Market Structure<sup>46</sup>**

Kosovo has low existing retail prices as a result of KESCO's position to purchase electricity from KEK with favorable conditions and below the market price (BSA between KESCO and KEK). These prices are lowest in Europe as shown in the Figure 14 below.

**Electricity prices for household consumers, first half 2020**  
(EUR per kWh)



(<sup>1</sup>) 2019 Semester 1 data.  
(<sup>2</sup>) 2019 Semester 2 data.  
(<sup>3</sup>) estimation.  
(<sup>4</sup>) Negative tax is caused by a refund (allowance).  
\* This designation is without prejudice to positions on status, and is in line with UNSCR 1244/1999 and the ICJ Opinion on the Kosovo Declaration of Independence.  
Source: Eurostat (online data codes: nrg\_pc\_204)



**Figure 14: Electricity Prices for Household Consumers, First Half 2020 (Source: Eurostat)**

The price of electricity for end customers consists of the cost of electricity including:

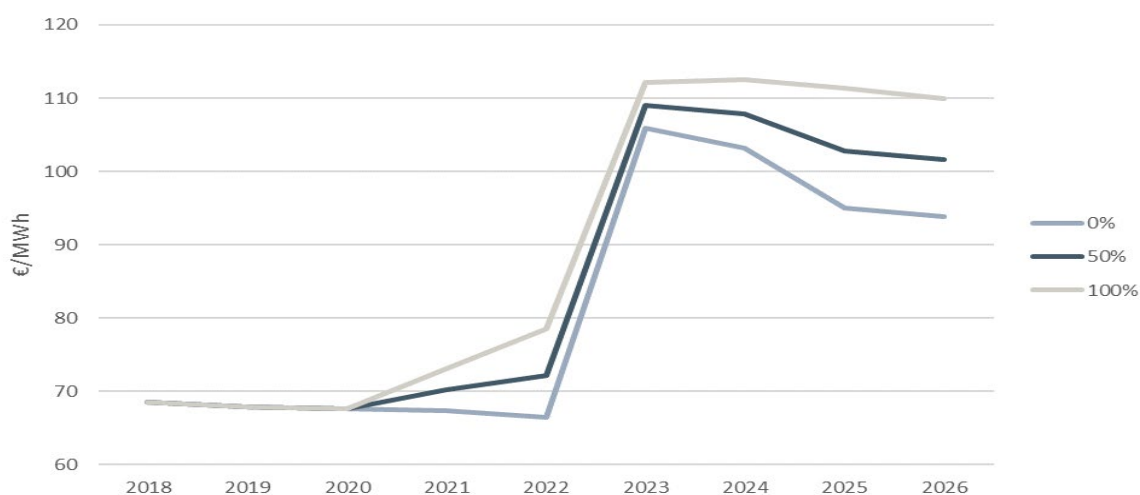
1. Primary source costs:
  - The costs arising from the RES Fund obligations; and,
  - The operating costs of the transmission system and / or the distribution system.
2. Supplier's fee, and
3. VAT (8%).

There are currently no studies for projection of retail electricity prices by 2030, however, based on USAID's REPOWER-Kosovo project report, with starting the real competitive wholesale market in

<sup>46</sup> Source: KOSTT Draft Market Design.

Kosovo, the retail prices for universal service supply customers may be 17% higher than in the current uncompetitive market. At the same time, the retail prices for non- universal service supply may be 2.5% lower than the current prices. This is shown more in Figure 15 below:

The significant increase of retail prices from year 2022 as presented in figures above, is due to planned investments in rehabilitation of the existing thermal power plants, or installation of the new generation capacities to ensure security of supply by 2040.



**Figure 15: Universal Service Supply Retail price (€/MWh) Under Different Convergence Scenarios, Very High Growth<sup>47</sup>**

## ELECTRICITY MARKET COUPLING ALBANIA - KOSOVO

The energy market is closely linked to cross-border cooperation. As mention above, Kosovo's electricity transmission system enables the exchange of electricity with neighboring countries, and also supports the transit of energy in all directions. Therefore, Albania and Kosovo almost ten years ago initiated the idea for a joint electricity market. However, this idea formally started at the beginning of March 2016, when the two governments signed a Memorandum of Collaboration. Also, the governments of Kosovo and Albania signed a Joint Statement confirming their earlier common market ambitions and emphasizing that a phased approach to this would be best. The first phase will be the establishment of an Albanian Power Exchange ALPEX.

In addition, in May 2016, the TSOs, KOSTT and OST signed an agreement for KOSTT to “join the initiatives of OST for establishment of Power exchange in Albania in form of a shareholder.” These drivers emphasize a continuing close coordination between Kosovo and Albanian institutions in the development of Kosovo’s participation in the Albanian Power Exchange.

All these efforts resulted with the following main achievements:

---

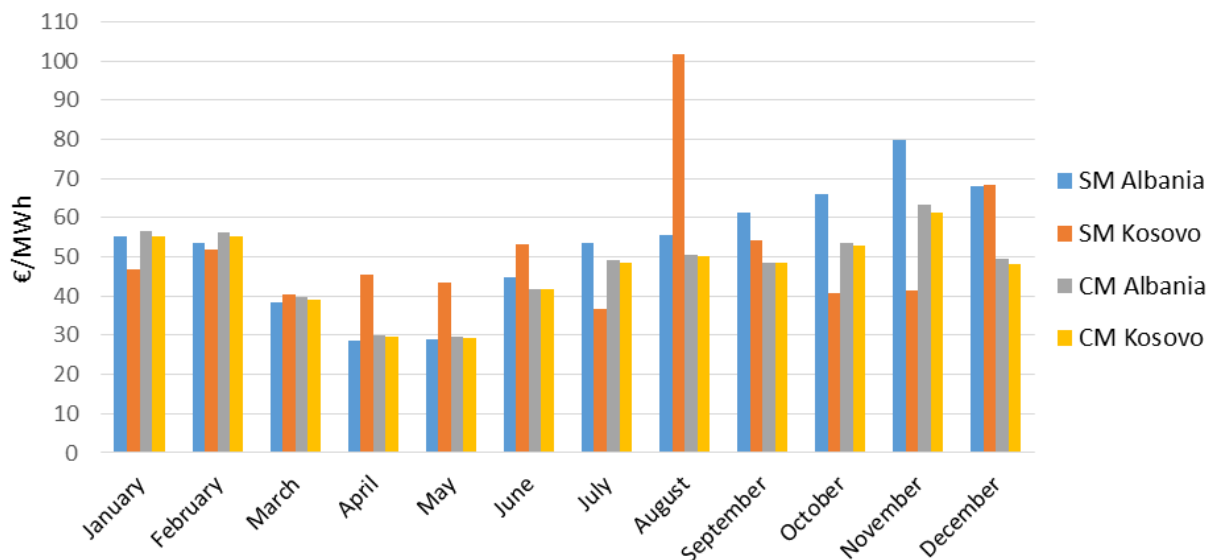
<sup>47</sup> Source: REPOWER-Kosovo Report.

- A number of agreements have been signed between TSOs and Regulators relevant to functioning of PX and market coupling;
- Albanian Power Exchange (ALBPEX) was established in November 2020; and
- KOSTT is Shareholder in ALBPEX.

Most important for the functioning Electricity Market was signing of connection agreement between KOSTT and ETNSO-e in November 2020, where KOSTT will operate as a Load-Frequency Control (LFC) Area within the Albania – Kosovo LFC Control Block and within the Continental Europe.

### BENEFITS OF ELECTRICITY MARKET COUPLING ALBANIA - KOSOVO

The integration of electricity markets is the goal of all countries in the region and in the energy community. The electricity market coupling Albania - Kosovo is ensuring improved energy balance, improved provision of reserve capacities, and increased security of supply for both countries. Besides, these benefits the coupled market AL-KS will have impact on electricity market prices. The chart below shows the impact of the coupled market AL-KS on electricity prices.



**Figure 16: Electricity Wholesale Prices in SM and CM in Kosovo and Albania<sup>48</sup>**

From the chart above we can see that in the electricity coupled market the wholesale market prices decrease in both Albania and Kosovo. In the single markets the average wholesale price is 52.73 €/MWh for Albania, and 52.01 €/MWh for Kosovo. But, in the coupled market the wholesale price is 47.73 €/MWh (-10.2%) for Albania, and 46.63 €/MWh (-10.34%).

Considering all these benefits, the governments and institutions including system operators in both countries are continuing their efforts for functioning of ALPEX and creation of coupled electricity market. The following activities are foreseen in the upcoming period:

---

<sup>48</sup> Source: REPOWER Presentation HLEF -2016.

- Technical preparations and selection of service provider who will provide platform for electricity trade in Day Ahead Market (DAM) and Intra Day Market (IDM);
- Creation of ALPEX branch in Kosovo;
- KOSTT – ALPEX Agreement for functioning of DAM and IDM in Kosovo, to be provided from ALPEX;
- NEMO designation in both countries;
- Market Coupling which may start the same day with starting DAM/IDM.

The Electricity Market Coupling with Albania is a first step towards regional coupling, as required from third package of Energy Community.

## **GENDER INCLUSION, EDUCATION AND JOB OPPORTUNITIES IN RES/ PV SOLAR SECTOR IN KOSOVO**

This section provides information on the current job market and potential employment opportunities within the PV sector in Kosovo. To have a concrete and reliable picture of the actual situation, a total of 15 companies were identified as businesses operating in the solar PV field, by either producing solar PVs or developing, installing, and maintaining solar PV projects. Out of the 15 identified companies, a sample of five companies was selected for face-to-face interviews, based on their size, number of projects and availability. Moreover, interviews were conducted with representatives of the below-mentioned academic institutions and training centers to receive data on curricula, gender-balance and current and future educational opportunities. Additionally, a webinar between KESS representatives, the head of agency for gender equality in Kosovo, the focal point for gender at MEE, and representatives of the Association of Women in Energy Section in Kosovo (AWESK), took place as a means of gathering information on women’s role in energy sector in Kosovo.

### **EMPLOYMENT OPPORTUNITIES**

The positive projections for future PV installation investments in Kosovo have encouraged companies to focus more seriously on upgrading and developing their PV market businesses, promising increased future employment opportunities within the sector.

As indicated above, 15 companies are currently active within the Kosovo solar industry, including one assembly plant for solar panels that also provides PV installation services as well. Out of the 15 companies, only five can be considered as strong market share competitors, not only within Kosovo, but also throughout the Balkan region. These local companies closely cooperate with renowned global companies in different regions of the world including Europe and Asia, and have been investing a lot in capacity building and certified professional trainings of their staff in solar technologies. As these companies continue to develop their professional capacities, their employment potential within the industry will also continue to increase.

The biggest employer currently in the solar business in Kosovo is the solar panel assembly plant, with 50 full-time employees (50% females and 50% males) on the production line. It is expected that the plant will add an additional 70 employees to the production line as demand continues to increase within the PV solar market. Additionally, the company has a variable number of labour staff involved in the installation of solar panels, depending on the number of projects they have in pipeline.

For the other companies surveyed for this report, which operate in Kosovo through project development and installation of PV solar systems, their employment structure consists of between 14 – 25 full-time employed staff. Out of these, 12-14% are engineers specializing in RES, 85% are specialized and licensed technician installers, and the remaining 3-4 % are involved in administrative positions such as finance, sales, and marketing of solar products. The companies also employ temporary short-term labour staff (30-60 persons) during peak installation seasons, depending on the specific project workload.

Two or three of the reviewed companies are planning to expand their businesses in the region and have already developed concrete projects in Albania, North Macedonia and Montenegro and are planning to send their staff for further training abroad for specialized training in the field of marketing and project management for PV solar projects.

At this stage, the number of employees within the solar companies is still modest, however, given the global trends with regards to RES and specifically Kosovo's obligations as part of the Energy Community, it is predicted that there will be a much higher demand for increased employment within the PV sector for different profiles. Interviewed companies estimate that more than 2,000 public building institutions, 10,000 houses, 1,000 businesses could have installed PV systems on their rooftops for self-consumption, within the next 5-10 years. These figures and projections have encouraged the companies to focus on the PV solar business, requiring an urgent mobilization of a highly qualified and skilled labor force.

At this stage, the companies operating in PV solar industry have expressed their concerns on the lack of qualified and skilled human resources available in this field. Engineers that graduate from both public and private universities lack practical experience and companies therefore need to invest at least five or six months in providing additional professional trainings until they get the necessary practical skills for their positions. These are rather expensive investments for the companies as they have to send them abroad for their licensing in the PV solar technologies.

In Kosovo, there is also a lack of skilled technicians – installers, as there are no technical or vocational schools in this field in Kosovo. There is also a lack of specialized staff profiles in PV solar - project design, project management, work inspections, sales, and marketing. The lack of a specialized labour force may affect the future employment demands and can hinder the employment opportunities at a larger scale in Kosovo in the RES sector. In this context, urgent specific measures are needed to be undertaken by governmental education and training institutions/centers to create an adequate environment for developing education and training facilities with specialized educators and trainers in RES and PV solar energy that can equip the new potential job seekers with the necessary market demand skills and who can respond to the labour market demands. Further partnerships with international leading companies in RES and PV solar technologies should also be considered for further capacity building and specializing opportunities in the related fields.

Based on rough estimation of the PV solar companies in Kosovo, for each 1 MW of installed capacity there is a need of at least 15 well trained labour staff/installers, which requires intensive work between 30-60 days. Whereas, based on international study estimations, spending USD 1 million on renewables creates 7.49 full-time jobs on average – which is almost triple the 2.65 jobs in fossil fuel.

Overall, sustainable job creation in Kosovo will depend on stable and predictable deployment policies which are currently missing in Kosovo. Assuming there are net employment benefits from deploying



renewables, the jobs created will be cost-efficient only if employment policies are adequately designed, stable, consistent, and long-term. In this regard, the Kosovo government should build policies that minimize non-economic barriers, and consequently address economic barriers through various financing methods. Furthermore, support schemes for renewable energy should be used to stimulate job creation.

In order to achieve installation targets and stimulate employment growth in the RES (PV) sector, it is necessary to facilitate and increase education and training opportunities. A large-scale shift to renewable energy will require a blended skillset of competencies from both the conventional energy workforce and renewable-specific technologies. Therefore, it is advisable to conduct a skills mapping exercise to identify existing skills, and skills gaps. From this, an appropriate training and education curriculum can be developed, to help match jobs and worker's skills and focus job creation in areas with low employment. This can be achieved if there is sufficient dialogue initiated between the government, companies involved in renewable business and professional associations specializing in RES.

Some of the key workforce skills needed to expand RES employment in solar (both PV and thermal systems) include:

- Research and development of advanced solar technology;
- Design and installation of solar panels;
- RES project development and consultancy in solar PV;
- RES manufacturing skills in module assembly and system integration for solar PV;
- Construction and commissioning of solar thermal systems;
- Grid integration of MW scale solar PV power projects;
- Operation and maintenance of RES (PV) systems including trouble shooting of circuitry of solar PV panels; and,
- Marketing and promotion of RES energies (sales and customer care).

## **EDUCATION OPPORTUNITIES IN RES AND PV SOLAR**

As indicated above, in Kosovo, there is a limited number of persons with relevant education, knowledge, and skills in RES or specifically in PV solar technologies. Currently there are only two universities, one public – Mechanical Engineering Faculty (RES Department), and one private – UBT University, that offer specific study programs for Bachelor (BSc) and Master's (MSc) degrees in Renewable Energy Systems. Other faculties, such as electrical engineering, civil engineering or in natural and applied sciences provide only small modules in renewable energy within their Bachelor study programs. The faculty of Architecture provides a one-year MSc in Energy Efficiency for residential buildings.

The total number of students at the Faculty of Mechanical Engineering currently attending RES study programs in BSc and MSc is 350. In the BSc study programs in RES, 74 students are enrolled per year, while 20 students graduate per year. 100% of the graduates from these BSc programs get immediate jobs (in-country or abroad) in their related renewable energy field. 60% of the graduates from these programs are women and 40% are men, which show that women are very much attracted by the RES engineering studies. In the MSc study program in RES, usually nine students are enrolled per year, while five or six students graduate. Most MSc students find immediate job employment opportunities (even before their graduation).

At UBT University, there are currently 100 active students in BSc study programs in the field of engineering and 40 active students attending MSc studies. The total number of the students that can enroll in MSc studies is limited to only 20 per academic year. Within these programs, the percentage of UBT students within engineering branches is 80% male and 20% female. Both the Faculty of Mechanical Engineering and UBT University programs highlight the limited available academic opportunities for students interested in the RES field. Opportunities to work with these institutions to expand programs and further develop curriculum should be explored. A current list of accredited academic programs in Kosovo with RES-related components is listed in Table 13 below.

**Table 13: List of Accredited Study Programs that Include RES and Solar Modules/Topics**

No	Study Program English	University /Faculty/College	Public/Private	Campus	Level	ECTS	Accredited Until
1.	Electro-energetics	Faculty of Electrical Engineering	Public	Prishtine	BSc	180	30/09/2020
2.	Energy Efficiency	Faculty of Civil Engineering and Architecture	Public	Prishtine	MA Professional	60	30/09/2022
3.	Environmental Engineering	Faculty of Civil Engineering and Architecture	Public	Prishtine	BSc	180	30/09/2022
4.	Industrial Engineering and Management	Faculty of Mechanical Engineering	Public	Prishtine	BSc	180	30/09/2020
5.	Thermo-energetics and Renewable Energy	Faculty of Mechanical Engineering	Public	Prishtine	BSc	180	30/09/2021
6.	Thermo-energetics and Renewable Energy	Faculty of Mechanical Engineering	Public	Prishtine	MSc	120	30/09/2021
7.	Engineering and Informatics	University of Applied Sciences	Public	Ferizaj	MSc	120	30/09/2022
8.	Industrial Management	University of Applied Sciences	Public	Ferizaj	MSc	120	30/09/2022
9.	Industrial Engineering with Informatics	University of Applied Sciences	Public	Ferizaj	BSc	180	30/09/2020
10.	Energy Engineering and Management	UBT College	Private	Prishtine	Level V	120	30/09/2021
11.	Energy Engineering and Management	UBT College	Private	Prishtine	BSc	180	30/09/2021
12.	Electrical Engineering	UBT College	Private	Prishtine	MSc	120	30/09/2022

Creating adequate education courses for developing and strengthening the role of Kosovars throughout the entire energy supply chain—from production to users—is essential to developing employment opportunities and expanding RES utilization in Kosovo. If properly designed either through local universities or technical and vocational education and training (TVET) facilities, these

courses will develop the local expertise needed to replicate and scale-up successful initiatives, support ownership of stakeholders, and foster sustainability beyond the withdrawal of external partners.

Since renewable energy projects are often planned a number of years in advance, effective skills anticipation work would be desirable for the Kosovo labour market. For each sub-sector, employment in project development, construction and installation can be linked to the rate at which new capacity is being installed. For all skills anticipation, it is paramount to ensure all main stakeholders are engaged, including renewable energy businesses, workers' representatives and providers of education and training.

Existing university courses in Kosovo in areas such as engineering, biosciences, geosciences, agriculture and forestry, and business can provide the necessary foundation for professional-level work in renewable energy. Respective universities should already start shaping their courses to better reflect the growth of interest in renewables. Continuing education and training is important for the renewable energy sector. Providers are diverse, including renewable energy businesses, industry associations, trade unions, technology suppliers, universities and colleges, and private training providers. One of the key challenges in Kosovo, is a need for sufficient and appropriately trained personnel to cope with the growing need for professionals, and particularly for specialists with advanced skills like engineers and technicians in RES and PV solar.

The re-training of workers in the fossil fuel industries and the training of young people entering the labour market are key elements for a smooth transition to a low-carbon economy. If sufficient quality and efficient training programmes are not provided, there is a serious threat of the renewable energy sector experiencing shortages not only in technical occupations, but also in more general occupations, such as sales specialists, inspectors, and auditors. Flexible training initiatives focusing on retraining the existing workforce, in particular, for construction/installation occupations are worth considering.

Continuing education and training systems (such as internships) relevant to renewable energies are also a critical part of developing education opportunities and can be organized by relevant business associations involved in RES and PV solar systems, AWESK can also play an important role in encouraging young girls to opt for studies and training courses in RES and solar energy and assist them through mentorship programs in these relevant field. At higher-skilled levels, universities should also engage closely with respective partners to determine course content and establish links with industry. Collaboration and partnerships with institutions within the renewable energy field through staff exchanges, internships, or placements, is another practical way to ensure best practices and skills are being taught and learned.

Additional facilities that could be important to expanding education opportunities for RES are listed in the section below.

### **CENTER FOR ENERGY AND SUSTAINABILITY (QEQ)**

The Center for Energy and Sustainability (QEQ) is a part of the University of Prishtina, established in 2018 with support from USAID and Arizona State University. The Center aims to take an interdisciplinary approach to address the local and global challenges of sustainability. It provides certified programs in “renewable energy and sustainability,” and it connects faculty members from across academic disciplines at the University of Prishtina and with academics from universities

throughout the world. These kinds of connections ensure that students and faculty in Kosovo have access to education, opportunities, and the resources they need to be successful.

QEQ provides certified program courses in RES fields that can be attended by students at the University of Prishtina of all levels, who meet the pre-requirements of the respective course as defined in the syllabus of the course. The certificates are issued only upon completion of four courses that all together carry 20 European Credit and Transfer and Accumulation System (ECTS). This center, could provide a useful starting place for either finding qualified staff to teach RES courses or to expand educational programs for interested students/candidates.

### **ROCHESTER INSTITUTE FOR TECHNOLOGY RIT/A.U.K**

The Rochester Institute for Technology (RIT/A.U.K) provides a study program on Public Policy, and only one semester in Energy Policy as a selected subject (three-ECTS) without any specific course module on renewable energies. Similar to the QEQ, RIT's current Public Policy program could be starting place in developing a more comprehensive curriculum targeted at RES skills/training. RIT could also expand its previous internship programs with energy and government institutions (such as the ERO, KEK and MEE) to include RES-tailed internship positions for students to expand practical education skills.

### **VOCATIONAL AND EDUCATION TRAINING (TVET)**

There are many TVET centers and the technical schools (secondary upper level) in Kosovo which could support expanded education opportunities. These centers, specialize in vocational training of technicians who are in large demand within the renewable/PV solar market business, especially in installation works for the PV solar panels. However, the TVET sector is not adequately regulated to provide the labor market with potential employees who possess skills that make them immediately attractive for prospective employers. One of the challenges of the VET system is the misalignment of the VET teaching curriculum and private sector skillset demands. The teaching curricula within energy field is outdated and not in compliance with the market needs, while there are also not yet any specific programs related renewable energy. However, TVETs could provide opportunities for continuing education, providing RES-tailored skillsets to prospective candidates.

### **KEK TRAINING CENTER**

KEK Training Center provides trainings to KEK's employees to contribute to the required practical qualification of the company's staff, while also contributing to other innovative programs that would serve KEK overall. It has further extended its capacities to offer trainings in various fields for all interested candidates in Kosovo. The training programs offered by this Center are accredited programs and are recognized on the international level and enable the candidates to develop their practical skills in several fields, such as electricity, mechanical operation, welding, heavy machine operation, workplace safety and management and administration. Currently, the Center does not provide any specific training program in renewable energy, nor in PV solar panels, but can further consider expanding its activities in this direction depending on the future of KEK's Strategy in developing large PV solar projects. The training center facility could be easily adapted and equipped with lab equipment for renewable energy and offer trainings for KEK's staff, as a smooth transition into the renewable energy future. This action would require a training of the trainers first, who would later train the KEK personnel and other interested candidates in renewable technologies.



## **KEDS ACADEMY**

KEDS Academy is a part of the Kosovo Company for Electricity Distribution and Supply (KEDS), which was established as an initiative of KEDS for effective solutions to problems faced by gifted students in Kosovo, providing practical knowledge and expertise through training and internship programs. The Academy offers accredited (12 ECTS credit) programs to higher education students and other interactive programmes for secondary school students at the technical secondary schools in Kosovo with the goal of decreasing the number of unemployment people by offering employment at KEDS and/or knowledge in employment at other similar companies. The KEDS Academy could expand its programming to support students interested in RES fields, offering targeted RES trainings or internship programs to interested students.

## **RECOMMENDATIONS**

After review of all the different educational opportunities within the Kosovo RES sector, the following recommendations for education-specific expansion are suggested:

1. Standards for specific profiles in RES or PV energy should be developed in conformity with the European Qualification Framework (EQF), National Qualifications Framework (NQF), as well as the revised National Occupations Classification System.
2. Core curriculum in RES and solar should be drafted and adapted by the Ministry of Education, Science and Technology for TVET schools.
3. Development and implementation of the combined TVET pilot curriculum system with elements of dual learning (combination of learning in schools and in RES/solar enterprises) in compliance with core curriculum. A similar system could be applied at universities that provide study courses in RES fields.
4. Organize career orientation sessions and awareness raising campaigns with young girls and boys in primary and low secondary schools, for promoting the importance of RES and solar for Kosovo in energy saving and environmental protection. Sessions could also support facilitating a future study orientation for renewable energy programs (options and opportunities).
5. Create conditions for support services and studies in order to track career progress at higher university level within the RES departments, QEQ or abroad.
6. Develop more specific internship and mentorship programs for the students opting for RES study programs at the enterprises involved in RES and PV industry.
7. Encourage exchange study opportunities with international universities that provide more specific study programs in RES and PV Solar systems.
8. Relate research work at universities with industry in RES and solar by facilitating access to smart specializations in line with Europe's 2020 strategy on RES and PV industrial sectors.
9. KEK Training Center can be extended and adapted for providing professional trainings in RES and PV for existing KEK staff and other interested candidates in cooperation with professional associations in RES and solar industries.

## GENDER IN ENERGY SECTOR RES/PV SOLAR

The Kosovo energy sector is filled with pervasive gender inequalities and gaps that span across energy access, the employment market, energy-related education, and decision-making within the sector.

Kosovo adopted the Law on Gender Equality in 2015, that calls for the development of policy measures and instruments at both national and local levels in all sectors, including the energy sector, and establishes institutions and gender equality mechanisms to integrate the principles of gender mainstreaming into all relevant legislation. Namely, it is the only Law on gender equality in the Western Balkans that states that “*equal gender representation in all legislative, executive and judiciary bodies and other public institutions is achieved when minimum representation of fifty percent (50%) is ensured for each gender, including their governing and decision-making bodies of women and men*”.

Unfortunately, implementation of this law has been a challenge in Kosovo. In the Kosovo energy sector, the uptake and implementation of gender equality policies has thus far been very slow. There is a lack of formal evidence on whether this process is being translated into policy documents, legal frameworks, strategies or energy programs. Although there is a rough estimation that less than 10% of the energy sector workforce is women, there is a lack of disaggregated data on the percentage of women engaged within the energy sector as per positions they hold within their respective energy institutions.. Despite this lack of formal evidence, it is evident that the number of women engaged in these institutions is still very low.

Energy enterprises need to address these systemic problems by empowering women with economic opportunities, as greater demand for RES energy services continues to increase. As job growth in the renewable energy sector continues, it is both essential and wise for business leaders to develop and implement policies that create a more gender based inclusive workplace. From a legal perspective, currently none of the laws within the energy sector, or any national development strategies or action plans on renewable energy, contain any gender inclusion analysis or perspective.

Currently, the environment for women within the energy sector is limited. Within PV businesses surveyed, the gendered employment ratio within the companies staff varied from between 12-14% female and more than 85% male. Women engineers within RES are well represented within this 12-14% and they show very good performance in project planning and design, in project management of PV solar projects, and also in other administrative and finance related positions. Through the survey, technical installation of PV panels showed 100% representation only male staff. This is mainly due to lack of technical skills but even more due to lack of interest from the female students to get engaged in the technical works. Stigma and social norms related to who can do these technical positions, also play a role.

There are some current local initiatives supporting women that apply RES and PV solar within their businesses, but these are sporadic project interventions without any systematic follow-up or long-term sustainability. A few international donor projects also apply some specific incentives for women within their projects (GiZ, MCC and USAID) encouraging engagement within the renewable energy sector and with energy efficiency measures. One example of this is the MCC program that provided scholarships for 22 young female students for their MA studies in U.S on renewable energy and energy efficiency.

Another grant scheme for women entrepreneurs has been launched recently by MCC, with specific incentives for those women applicants that apply solar panels and energy efficiency measures in their projects. However, through a webinar conducted between KESS representatives, the head of the gender agency in Kosovo, along with AWESK representatives, and the focal point for gender at MEE, it was revealed that the application process for women entrepreneurs appeared to be very complex as they did not have experience in dealing with grant projects. Additionally, a lack of knowledge on PV technology and other energy efficiency measures required to be described within project application forms discouraged many women from applying for these grants.

The USAID KESS activity also recently provided capacity building training to 51 women representatives of AWESK, including trainings on Energy Efficiency, Energy Tariffs and Use of RES systems in households and businesses. AWESK members trained under this USAID support, joint partnership with PV solar installers/companies could be further mobilized to providing similar trainings to the women entrepreneurs (small and medium sized companies) in utilizing both energy efficiency measures and PV technology in their businesses.

Despite these limited above efforts, more needs to be done to increase women's participation within both the energy workforce and within academic programs. Gender mainstreaming within energy sector in Kosovo should be applied by considering specific needs of women in the sector and gender mainstreaming strategies should be included in all strategies and action plans for respective energy entities and utilities, including the Agency for Energy Efficiency as per the Law on Gender Equality and EU Agenda requirements for pre-accession. Mainstreaming should be based on two key principles: 1) that women and men have different needs, roles, interests and access to resources and their benefits, and 2) that women and men must play equally important roles in energy sector and RES sector.

Respective action plans should be drafted with specific measures for women inclusion associated with specific budget lines for implementation. In this process, it is of crucial importance to involve women engineers (AWESK), women entrepreneurs and other women NGOs and from civil societies, to represent women needs and interest in energy efficiency and renewable energy sector. Women should be part of all initial working groups from policy drafting process, so as in strategy and action plan drafting processes, and also involved in implementation, monitoring and supervision of the same strategies and project initiatives at both national on municipal levels.

## **RECOMMENDATIONS**

After review of all the different employment, education and gender inclusions opportunities within the Kosovo RES sector, the following recommendations for improvement within the sector are provided below:

1. Universities should strengthen their partnerships with renewable industry associations in matching better their training programs and curricula as per market-oriented demands in RES. Encourage industry experts to work as guest speakers related to RES solar PV.
2. Universities should establish close partnership with Center for Energy and Sustainability (QEQ) and recommend students in advancing their practical knowledge and understanding of RES and solar energy through the program modules that QEQ is providing in RES.
3. Universities in partnership with RES industry associations could facilitate summer internships for students in RES and facilitating them in pilot projects within their respective fields.



4. GoK could stipend programs to motivate students opting for RES study programs in-country and abroad.
5. GoK/Ministries should organize Renewable Energy Job Fairs once a year to attract new job seekers (particularly women) within the sector industry.
6. Awareness raising and outreach programs on RES could be organized by the government, supported by donors, to promote Kosovo's RES and energy efficiency objectives and how to reach the EU targets. Programs could also focus on introducing education and career orientation opportunities in Kosovo for RES and the solar industry.
7. GoK in partnership with donors, can extend and adapt the facilities of KEK's training center for provision of vocational trainings to existing KEK staff and other students/technicians in RES (solar,) in joint cooperation with specialized associations in RES technologies and industry.
8. Training of Trainers (ToT) program can also be encouraged for university or TVET staff, to provide a certain number of qualified and certified trainers in RES, so that further training to the new students and job seekers in RES can be conducted.
9. GoK in partnership with donors, can set up an incubator for supporting green entrepreneurs for both women and men who want to get involved in manufacturing of RE products, including solar PV products and components, and related technologies for creation of new jobs in RES.
10. GoK in partnership with donors, can design and conduct special training programs at national and municipal levels on green entrepreneurship, with a specific focus on RES (PV).
11. GoK can allocate specific funds or loans at favorable interest rates, or grant schemes for encouraging new SME enterprises to work on RES.
12. Specific grant schemes should be designed or further developed, to encourage women entrepreneurship in applying RES (including PV systems) to their businesses.

## APPENDIX I. UTILITY SCALE BATTERY STORAGE SYSTEMS

What is Utility Scale Battery Storage Systems / Stationary battery energy storage systems (BESS)?

Variable renewable energy (VRE) refers to renewable energy generation resources whose output is not perfectly controlled by an energy generation operator and is difficult to predict, such as, and primarily being wind and solar energy (in certain cases hydro-electricity without storage capacity is considered as a VRE, as the energy output is dependent on the water streamflow at any given moment). Stationary Battery Energy Storage Systems (BESS) or Utility Scale Batteries enable a greater feed of VRE into the grid, due to their capability to quickly absorb, store and reinject excess generated electricity/energy, hence control the renewable energy output and utilization, and optimize the power and frequency balance process.

When and why is it needed?

Stationary Battery Energy Storage Systems (BESS) are becoming the key solution in effectively integrating high shares of VRE in power systems worldwide, and help in providing reliable and cheaper electricity in remote, small and off grid communities. BESS are typically connected to distribution or transmission networks, or in direct connection with a renewable energy generator (such as wind, solar PV or hydro). The continual and accelerating increase in VRE penetration will further drive the demand for Stationary BESS, which provide the following key services:

1. Services for System Operators:

- **Frequency regulation:** An imbalance between the power supply and the power demand can lead to a decline or rise in grid frequency. Stationary BESS can provide frequency regulation services in milliseconds.
- **Flexible Ramping:** When VRE production starts to increase (due to specific and variable conditions), the energy load curve changes dramatically. The system is required to ramp downwards when generation increases and ramp upwards when generation decreases and demand increases. Stationary BESS would be suitable to help meet these ramping requirements and flatten the load curve.
- **Black Start Services:** In the event of grid failure, restoration of energy generation plants requires power to start up again, which is referred to as black start. Stationary BESS can provide black start services in cases of grid failure (instead of diesel generators).

2. Services for Investment Deferral:

- **Energy Shifting and Capacity Investment Deferral:** Stationary BESS are well suited to serve as capacity reserves for electricity suppliers, as they can discharge during peak hours, displacing peak generators and deferring further investment in energy peaking plants.
- **Transmission and Distribution Congestion Relief:** During peak demand, transmission and distribution networks may face network congestion, as the energy flow exceeds the carrying capacity of the networks. To avoid network congestion, operators usually increase their distribution and transmission infrastructure, which is not the most appropriate when congestion occurs in a limited / specific period. Utility scale battery storage systems can be used to store energy from renewable energy generation, in order to address the peak demand which exceeds the network capacity. Additionally, battery storage systems can provide instantaneous response to transmission-distribution network systems to manage any variability caused by generation from renewable energy sources.

### 3. Services for VRE Generators:

- **Reduced Renewable Energy Curtailment:** As VRE generators do not have a controllable fixed output, instances when the generation is higher than the demand lead to energy curtailment, which is a purposeful reduction in renewable energy production or output, below the levels that could have been produced. Utility scale battery storage systems are one of the solutions for reducing renewable energy curtailment, as excess electricity can be stored and then used at demand.
- **Capacity Firming:** As VRE generation is very variable (due to wind speed or sun exposure), adding utility scale battery storage systems to a VRE generation source reduces the variability of the power output at the point of grid interconnection, thus facilitating better integration of renewables. The battery storage system can smoothen the output of VRE sources and control the ramp rate to eliminate rapid power fluctuations in the grid. Further, this will allow renewable energy generators to increase compliance with their electricity production schedules and avoid penalty charges for any deviation in generation. In addition, the capacity firming will allow renewable energy generators to take better positions in energy market-based auctions for energy as it would increase the certainty and availability of power.

### 4. Services for Small Grid Systems:

Small Grid Systems (such as in remote communities or islands) have typically relied on diesel generators for reliable energy supply. As VRE generation has become cost competitive, their deployment in small grid systems is increasing. However, as it is difficult to estimate the energy demand and supply in remote areas (also due to the lack of flexible sources of generation), utility scale batteries can help balance the load by charging and discharging as needed. This will lead to an increasing in share of renewable energy generation and utilization in such communities.

## Stationary BESS Components

Implemented Utility Scale Battery Storage Systems / Stationary Battery Energy Storage Systems (BESS) typically consist of and include the following components:

1. **Battery System:** consisting of battery pack, which contains numerous battery cells of appropriate voltage and capacity; battery management system (BMS), which provides reliable and safe operations management of the system; and battery thermal management system (B-TMS), which controls the temperature of the cells.
2. **Operation Components:** consisting of components required for the reliable operation of the system, including system control and monitoring, the energy management system (EMS), and thermal management system. The system control and monitoring is partly combined into the overall supervisory control and data acquisition system (SCADA) and may also include fire protection or alarm units. The EMS is responsible for system power flow control, management, and distribution. The thermal management system controls all functions related to the heating, ventilation, and air-conditioning of the Stationary BESS.
3. **Power Electronics:** The power electronics can be grouped into the conversion unit, which converts the power flow between the grid and the battery, and the required control and monitoring components, such as voltage sensing units and thermal management of power electronics components.

## Battery Types

BESS have a typical storage capacity ranging from around a few megawatt-hours (MWh) to hundreds or now even thousands of MWh. BESS technologies can vary on energy density, charge and discharge (round trip) efficiency, life span, and eco-friendliness of the devices. Different battery storage technologies exist, such as lithium-ion (Li-ion), sodium sulphur and lead acid batteries. Lithium-ion (Li-ion) and Vanadium Redox Flow (Flow) batteries currently are the two most commercially viable battery systems for Stationary BESS or Utility Scale Battery Storage Systems.

### Lithium-Ion (Li-ion) Batteries

Li-ion batteries have seen the fastest growth and cost declines in recent years. According to the International Energy Agency (IEA), in 2017, Li-ion accounted for nearly 90% of large-scale battery storage additions. Multiple configurations of battery chemistries are available for li-ion batteries, making them attractive to electricity providers, especially for applications that require output duration of 4 hours or less. Lithium technologies have a high DC round trip efficiency (typically >85%), but experience annual degradation and have a service life of 10 to 15 years.

Li-ion batteries are used at scales ranging from toys and cell phones to electric vehicles and utility scale power systems up to 100 MW or larger. While this technology was originally only used for short-time applications, such as frequency regulation or renewables-firming, these batteries are increasingly used in longer duration (2- to 6-hour) applications. Recently lithium batteries are being supplanted by more advanced lithium formulations, including LiFePO<sub>4</sub>, which have better performance and are less flammable.

There are concerns that lithium will become increasingly scarce in the future, so new battery technologies are being researched, developed and brought to market.

### Vanadium Redox Flow (Flow) Batteries

Flow systems are recognized for their longer service life, the ability to provide a storage duration from 2 to 8 hours, and the flexibility to provide system sizing flexibility. Although the flow batteries are fairly new technology, numerous larger systems have been deployed, such as the:

- San Diego Gas and Electric and Sumitomo installation of 2 MW / 8 MWh flow battery in California, USA
- 200 MW / 400 MWh battery system in Dalian, China.

Flow batteries have a lower energy density than solid state batteries such as li-ion, which means that they use up more physical space per MWh of power and are only currently suitable for stationary applications. The batteries are non-flammable, which makes them safer than lithium, but the electrolyte does need to be safely contained. Flow batteries have a lower DC round trip efficiency (typically 70 to 80 percent) than lithium batteries. However, they have a theoretically unlimited cycle life (i.e. number of recharges during their usable life – currently at least two to three times that of lithium batteries) and a typical service life of 20 years or more. Although the batteries themselves have a lower energy density than lithium technologies, the containers can be readily stacked, resulting in a smaller total footprint for a given MWh capacity storage system. Further, vanadium flow batteries are more recyclable than lithium, and it is believed that there are large available reserves of vanadium. In addition to utility scale batteries, a US/Australian company (Stor-En) is starting the manufacturing in Australia of vanadium flow batteries for household, small business and small off-grid applications that are quite compact, with better performance characteristics than lithium batteries.

## EU Actions on Utility Scale Batteries

In 2019 the EU completed a comprehensive update of its energy policy framework to facilitate the transition away from fossil fuels towards cleaner energy and to deliver on the EU's Paris Agreement commitments for reducing greenhouse gas emissions.

The EU estimates that it will need 108 GW of battery storage to meet its climate targets by 2030.<sup>49</sup> Several additional EU reports on BESS include: "Implementation of the Strategic Action Plan on Batteries: Building a Strategic Battery Value Chain in Europe"<sup>50</sup>; "Batteries Europe"<sup>51</sup>; and "Energy Storage Europe"<sup>52</sup>.

What are the costs?

The cost of Stationary BESS components, including batteries, are projected to decline over the medium and long term. According to McKinsey & Company<sup>53</sup>, from 2012 to 2017, battery costs fell more than 15% per year, for a total five-year drop of more than 50%. In aggregate, balance-of-system (BOS) cost, other hardware, soft costs, and engineering, Procurement and Construction (EPC)—declined even faster: more than 25 percent per year.

The costs of Stationary BESS are typically described in two ways:

- **Cost per kW (MW):** the total installed cost of the system divided by the instantaneous output power rating of the system, or \$/kW-AC.
- **Cost per kWh (MWh):** the cost of the system divided by its projected energy output (if different, it needs to be specified if it is for usable storage capacity or rated storage capacity). The appropriate unit of measure is \$/kWh-AC.

In addition, for any given BESS, this cost metric can be expressed in the following ways:

- **Installed cost:** the equipment cost of the battery, balance of system (BOS) costs, and engineering, procurement, and construction (EPC) costs.
- **Levelized cost:** the cumulative cost to design, construct, and utilize the BESS over the course of its useful life (including maintenance costs, effects of battery degradation, etc.). When comparing a Stationary BESS against an alternative resource, the levelized cost of storage (LCOS) is the preferred unit of measurement.

Hence, the total cost of any BESS system includes the cost of the battery, BOS and EPC.

Of course, larger installations will reap greater economies of scale.

The first BESS installation in the Western Balkans is phase I of the NGEN installation in Slovenia, which is 12.6 MW / 22 MWh and the cost in total was 15 million EUR.

---

<sup>49</sup> <https://www.pv-magazine.com/2020/06/18/eu-needs-108-gw-of-battery-storage-for-2030-climate-targets/>

<sup>50</sup> <https://eur-lex.europa.eu/legal-content/EN/TXT/?qid=1571912028148&uri=CELEX:52019DC0176>

<sup>51</sup> <https://ec.europa.eu/energy/topics/technology-and-innovation/batteries-europe>

<sup>52</sup> [https://ec.europa.eu/energy/topics/technology-and-innovation/energy-storage\\_en](https://ec.europa.eu/energy/topics/technology-and-innovation/energy-storage_en)

<sup>53</sup> <https://www.mckinsey.com/industries/electric-power-and-natural-gas/our-insights/the-new-rules-of-competition-in-energy-storage>

The Eland Solar and Storage Center in Kern County, California that will become operational in 2022 will be 400 MWac solar PV and 1,200 MWh BESS. The electricity price to the offtaker will be less than 0.02 USD/kWh for solar alone and less than 0.04 USD/kWh for solar PV including BESS.

How to determine the size in MW and MWh of batteries needed?

Determining the optimal BESS size for a specific application is a complex task because it depends on a lot of factors and parameters, including:

- Application control strategy, which determines how the storage system is used for the considered application.
- Energy and power application needs over the project lifetime.
- BESS efficiency.
- Degradation of the performances of the battery over its lifetime (capacity and/or power degradation due to battery ageing).
- Uncertainties related to renewable energy sources, forecast errors, load demands, energy prices, etc.
- Realistic economical assessments to correctly evaluate investment as well as operation costs and incomes throughout the project lifetime.

### Example recent installations

Utility-scale battery storage systems have mostly been deployed in Australia, Belgium, China, Germany, Japan, South Korea, United Kingdom, and the United States. According to the International Renewable Energy Agency (IRENA), the energy storage deployment in emerging markets is expected to increase by over 40% each year until 2025. As cited above, Europe alone needs over 108 GW BESS by 2030. The following is a list of representative major installations of BESS:

- **Eland Solar and Storage Center, California, USA:** Started in 2019 and will be operational in 2022 with 400 MWac solar PV and 1,200 MWh BESS. The electricity price to the offtaker will be less than 0.20 USD/kWh for solar alone and less than 0.40 USD/kWh for solar PV including BESS.
- **Hornsedale Power Reserve, Australia:** the 100 MW/ 129 MWh Hornsdale Power Reserve is a large lithium-ion battery storage facility to stabilize the South Australian electricity grid, facilitate integration of renewable energy in the State and reduce the chance of load-shedding events.
- **NGEN, Slovenia:** NGEN Energy System Solutions have developed two large-scale Tesla Powerpack battery storage systems in Slovenia, including a 12.6 MW / 22 MWh storage system in Jesenice, and a 15 MW / 30 MWh system in Kidričevo. The two systems will be used for frequency regulation, lowering the balance groups imbalances and offering flexible support to other energy market participants, especially bigger consumers. This is the first BESS installation in the Western Balkans.
- **Edwards and Sanborn Solar and Energy Storage Project, California, USA:** Terra-Gen, a renewable energy developer, has partnered with construction firm Mortenson to build the world's largest standalone solar-plus-storage project to date, consisting of 1,118 MW of solar and 2,165 MWh of energy storage. Construction is estimated to begin in early 2021 and will utilise more than 2.5 million solar and more than 110,000 lithium-ion battery modules. This installation will be able to power 400,000 homes through the night.
- **STEAG, Germany:** German energy company STEAG has installed an aggregated capacity of 90 MW/120 MWh battery storage at six different sites in Germany, each having a battery storage capacity of 15 MW/20 MWh. Batteries are connected to the grid at 10 kV and are

intended to provide primary frequency control reserve for 30 minutes according to the requirements of the transmission system operator.

- **Minety Project, United Kingdom:** Shell Energy Europe Limited (SEEL) has agreed on a multi-year power offtake deal that enables the installation of Europe's biggest battery, the 100-megawatt (MW) Minety power storage project in south-west England. The 100MW Minety project will consist of two 50 MW ternary lithium battery installations.
- **San Diego Gas and Electric and Sumitomo installation, USA:** 2 MW / 8 MWh vanadium flow battery in California, USA
- 200 MW / 400 MWh vanadium flow battery system in **Dalian, China**.
- **Ruen BESS, Belgium:** 32 MWh.
- **Hyundai BESS, South Korea:** 150 MWh

In addition, several island and off-grid communities have invested in large-scale battery storage to balance the grid and store excess renewable energy. For example:

- In a mini-grid battery project in Martinique, the output of a solar PV farm is supported by a 2 MWh energy storage unit, ensuring that electricity is injected into the grid at a constant rate, avoiding the need for back-up generation.
- In Hawaii, almost 130 MWh of battery storage systems have been implemented to provide smoothing services for solar PV and wind energy.

Following is a representative list of stationary battery energy storage systems (BESS) manufacturers / providers:

- Tesla Powerpack (USA): <https://www.tesla.com/powerpack>
- MAN Energy Solutions (Germany): <https://www.man-es.com/>
- Fluence – Siemens and AES company (USA): <https://fluenceenergy.com/>
- NEC Energy Solutions (Japan): <https://www.neces.com/>
- Rolls-Royce Power Systems AG - MTU Solutions (Germany): <https://www.mtu-solutions.com/eu/en.html>
- ENGIE EPS (France): <https://engie-eps.com/>
- Samsung SDI (Korea): <https://www.samsungsdi.com/>
- Northvolt (Sweden): <https://northvolt.com/>
- Socomec Group SA (France): <https://www.socomec.com/>
- E22 Energy Storage Solutions (Spain): <https://energystoragesolutions.com/>

Following is a representative list of installers / contractors of utility scale battery storage:

- Wartsila Energy Storage & Optimization (Finland): <https://www.wartsila.com/>
- NGEN (Slovenia): <https://www.ngen.si/en>
- MW Storage (Switzerland): <https://www.mwstorage.ch/en/>
- Zenobe Energy (UK): <https://zenobe.com/>
- DNV GL (Norway): <https://www.dnvgl.com/>
- Jema – Irizar Group (Spain): <https://www.jemaenergy.com/en/>

## **BESS in Kosovo**

With the potential opportunities to add 300 – 500 MW of RES in solar PV and wind by 2030, it raises the question of auxiliary services, balancing, reserves, smoothing and frequency modulation. Despite the new agreement between KOSTT of Kosovo and OST of Albania for auxiliary services, both KOSTT and KEDS report that there will not be sufficient auxiliary services for Kosovo to add significant new amounts of RES to the grid. Pump storage hydro has been proposed as part of the

solution, but pump storage is very expensive, would take a long time to deploy, and has other obstacles. BESS has been proposed by the World Bank, MCC and others as a viable, affordable and fast to implement solution, and installations from 10 MW to 400 MW have been discussed.

BESS could be implemented in conjunction with the addition of large solar PV farms and/or wind farms. KEK indicated that there was discussion of BESS as a possibility in conjunction with its development of a 100 MW solar PV farm on its ash dump and/or depleted mine.

BESS could also be implemented independently from an RES installation with a connection to the grid. As mentioned above, the NGEN BESS in Slovenia is the first installation in the Western Balkans and is a good example.

In discussions with management, KEDS, the private electricity distribution company, expressed interest in installing BESS on its own land at a site or sites immediately adjacent to major grid connection points. For example, a BESS installation with the following possible parameters is of interest:

- 10-15 MW
- 20-30 MWh
- Two hour coverage
- 0.2 hectares land requirement
- Self-connection to KEDS grid

KEDS would be interested in pursuing a project in this ballpark with external financing from banks and/or DFIs such as the US DFC. (In addition, KEDS is interested in putting solar PV on the rooftops of all seven of its own warehouses on a behind-the-meter basis to offset some of its own consumption.)

The implementation and integration of these new renewable energy projects requires further modernization and continuous strengthening of the network to cope with large influx of intermittent renewable resources. Kosovo will need to introduce the latest technologies in energy storage, including battery storage system, and responsive system reserves to balance its power system. In effort to accommodate future renewable projects, USAID will support Kosovo in creating sound legal and regulatory framework for integration and operation of these new technologies.



**U.S. Agency for International Development/Country**

Office Address Optional

**[www.usaid.gov](http://www.usaid.gov)**



# KOSOVO ENERGY SECURITY OF SUPPLY

## JOB ORDER KESS-027: ASSESSMENT OF PV GENERATORS IN KOSOVO

### ANNEX 3 – BARRIERS & RECOMMENDATIONS

January 2020

This publication was produced for review by the United States Agency for International Development.  
It was prepared by DT Global.

# KOSOVO ENERGY SECURITY OF SUPPLY (KESS)

## JOB ORDER KESS – 027 ASSESSMENT OF PV GENERATORS IN KOSOVO

### ANNEX 3 – BARRIERS & RECOMMENDATION

**Contract No:**

AID-167-C-17-00004

**Submitted to:**

USAID Kosovo

**Prepared by:**

DT Global

**Photo Caption:**

Roof top solar PV, Banja e Pejës. Photo credits: KESS

**DISCLAIMER:**

The authors' views expressed in this document do not necessarily reflect the views of the United States Agency for International Development or the United States Government.

# CONTENTS

<b>Executive Summary</b> .....	<b>5</b>
<b>Part I. Integration of renewable Self-consumers</b> .....	<b>8</b>
Policy Framework.....	8
Current status .....	8
Recommendations .....	10
Legal and Regulatory Framework .....	12
Current status .....	12
Recommendations .....	14
Technological and technical Requirements .....	20
Current status .....	20
Recommendations .....	22
Self-Consumption and Access to the Market .....	25
Current Status.....	25
Recommendations .....	26
Self-Consumption and Access to the Network .....	30
Current Status.....	30
Recommendations .....	31
Charges, Taxes and Levies.....	33
Current status .....	33
Recommendations .....	34
<b>Part 2. Large solar PV Generators (unsolicited)</b> .....	<b>35</b>
Current status .....	35
Recommendations .....	37
<b>Part 3. Large solar PV generators based on solicited (tender or auction) procedures ..</b>	<b>42</b>
Current status .....	42
Recommendations .....	43
<b>Part 4. Other Barriers (applicable to all generators)</b> .....	<b>45</b>
Current status .....	45
Recommendations .....	46

## **TABLES**

Table 1 Policy Framework Recommendations and Action items .....	10
Table 2 Legal and Regulatory Framework Recommendations and Action items.....	14
Table 3 Self-Consumption and Access to the Market Recommendations and Action items.....	26
Table 4 Self-Consumption and Access to the Network .....	31
Table 5 VAT and other Taxes and Levies Recommendations and Action Items.....	34
Table 6 Barriers and Recommendations for unsolicited generators.....	37
Table 7 Barriers and Recommendations for solicited generators .....	43
Table 8 Other Barriers and Recommendations .....	46

## EXECUTIVE SUMMARY

This Annex 3 is the third in a series of reports on the solar photovoltaic situation in Kosovo and provides recommendations on improving the legal and regulatory environment for solar photovoltaic (PV) deployment in the country. This Annex 3 report is divided into four parts, each focused on a different functional topic:

- Part I is focused on integration of renewable self-consumers;
- Part II is focused on large solar PV generators based on unsolicited procedures;
- Part III is focused on large solar PV generators based on forthcoming solicited procedures;
- Part IV is focused on all other barriers.

**Part I Integration of renewable self-consumers** is focused on generators for self-consumption, a small but important segment in solar photovoltaic (PV) framework that is gaining relevance in Kosovo. The renewable self-consumers (prosumers<sup>1</sup>) are the electricity consumers that produce part of their electricity needs from their own power plant and use the distribution network to inject excess production and to withdraw electricity when self-production is not sufficient to meet their own needs.<sup>2</sup> The recommendations of the Policy Guidelines on Integration of Renewable self-consumers, PG 03/2020 (the Policy Guideline), issued by the Energy Community Secretariat (EnCS) in September 2020, applies to prosumers. The Policy Guideline is a generic form developed to address all of the Contracting Parties (CPs) of the Energy Community (including Kosovo) through six groups of recommendations that are aiming to improve the renewable self-consuming environment:

1. Policy Framework
2. Legal and Regulatory Framework Recommendations
3. Technical and Technological Requirements
4. Self-Consumption and Access to the Market Recommendations
5. Self-Consumption and Access to the Network
6. VAT and other Taxes and Levies Recommendations

This Part I follows the structure of the Policy Guideline. Each recommendation is compared with the current circumstances in Kosovo to identify possible barriers and to provide specific, Kosovo relevant recommendations, in order to increase utilization of renewable energy for self-consumption.

Part I also provides recommendations for the Ministry of Economy and Environment (MEE) to develop secondary legislation on the reporting requirements for behind-the-meter installations that do not transfer electricity into the grid. This behind-the-meter energy produced is not yet counted in the national RES target. Reliable reporting of the installed behind-the-meter capacities will enable MEE to include this electricity in its RES targets. Another key recommendation is for MEE to develop the secondary legislation to establish the monitoring and reporting regime of key performance indicators of renewable self-consumption targets.

---

<sup>1</sup> Prosumer is expression created from two words: Producer + Consumer = Prosumer, to emphasize the specific position of the Renewable Energy Self – consumer, that is the consumer and producer at the same time

<sup>2</sup> Policy Guidelines by the Energy Community Secretariat on the Grid Integration of prosumers PG 01/2018 / 5 Feb 2018, available on EnCS web site: [www.energy-community.org](http://www.energy-community.org)

The Legal and Regulatory Framework section lists the gaps and obstacles and provides recommendations for improvement. For example, a recommendation to modify Law on Energy No. 05/L – 081 (June 2016) and the Rule on Support Scheme No 10/2017 (April 27, 2017) to clearly define rights and responsibilities of RES self-consumers and introduce different functional schemes in which prosumers act individually, jointly, through aggregation, or as an energy community. The current legal and regulatory framework lacks the majority of the recommendations in the Policy Guideline. Therefore, it is necessary to amend the law on energy and existing regulatory framework or adopt a new law on renewable energy sources. Kosovo should define clear, transparent, and non-discriminatory support schemes for each category of renewable self-consumers, with associated timeframes. The changes should be prospective and not retroactively negatively impact any already approved RES installations.

The current DSO connection procedures are complicated and not suitable for connection of new self-consumers. The procedures should be streamlined and simplified. As with the EU requirements, RES installations under 400kW should not have balancing responsibility.

To promote new RES self-consumption installations to the maximum possible extent, any charges, taxes and levies, should be kept to the absolute necessary bare minimum, especially for installations under 100kW.

## **Part 2. Large solar PV generators based on unsolicited procedures**

Part 2 presents the barriers that the Generator is facing when applying for authorization procedures to construct solar PV projects. The PPA is not guaranteed by the government (both on the payment for energy and on stability of the pricing methodology and regulatory framework), which inhibits lending to the project on a non-recourse basis. All the businesses interviewed during October – November 2020 have reported that they had fundamental problems in obtaining the grid connections with KEDS. In addition, they felt that KEDS' charges were unreasonably high.

Until recently the main applicable support scheme for RES generators was the feed-in tariff. The Energy Regulatory Office (ERO) at its Board meeting in December 2020 issued a decision to terminate feed-in tariffs. The ERO, however, did not decide which pricing mechanism will replace the feed-in tariffs, and has therefore left the entire process in limbo. This uncertainty has brought the entire process to a halt. The draft methodology for reference prices for RES generators is still not adopted and there is no reference price set by the ERO for the year 2021. This prevents potential generators from applying for RES installations. The ERO needs to adopt a pricing methodology for RES generators for 2021 that allows for cost recovery and reasonable return on investment.

## **Part 3. Large solar PV generators based on solicited procedures (tender or auction)**

The solicited competitive and transparent bidding processes are necessary for increasing investors' confidence and inviting credit project sponsors interest and submissions. Financing large solar PV projects in Kosovo is a process facing the political, policy, and off-taker risks perceived by lenders and project sponsors. Such barriers have impact on the increase of the risk premium on the cost of capital, making the project more expensive and increase the tariff. Key risks include counter-party credit risk posed by the weak credit worthiness of public sector off-takers such as KOSTT, policy and political risks related to change in policies, taxes, royalties, electricity prices, etc. which may impact project revenues, and business interruption risks which may impact power generation and project revenues.

Variable interest rates and non-Euro financing could also be a risk depending on the lenders to the project.

The terms and conditions of the PPA, the implementation and grid connection agreements and contracts will be critical to the bankability of projects, and project risks will need to be mitigated with appropriate instruments

#### **Part 4. Other barriers**

This part is focused on all other barriers that are impacting all generators or the RES sector in general. Most of the obstacles covered in this part are related to non-implementation of already adopted laws and regulations or inadequate secondary regulations and policies.

Kosovo is developing its first National Energy and Environment Plan required in accordance with Clean Energy for all Europeans Package (CEP)<sup>3</sup> and is also in process of revising the Kosovo Energy Strategy. Through these two vital documents, Kosovo should set the key priorities, parameters, and implementation strategies to increase the utilization of RES and meet the targets set to be achieved by 2030. Kosovo should remove all the identified barriers that prevent households and businesses from installing solar PV for self-consumption and sale of their surplus to the grid. For larger RES generators that will primarily sell their electricity to the grid for a return on their investment, grid connection should be straightforward and reasonably priced, the price methodology should be definitive, fair, and stable over the tenor of the PPA, and the Kosovo government should guarantee the PPA revenues and stability of price and legal and regulatory framework.

---

<sup>3</sup> Clean Energy for all Europeans Package (CEP) is a legally binding framework adopted in the European Union (EU) that facilitates decarbonisation of the energy sector and sets 2030 targets for greenhouse gas emissions, renewable energy and energy efficiency



# PART I. INTEGRATION OF RENEWABLE SELF-CONSUMERS

## POLICY FRAMEWORK

### CURRENT STATUS

The Energy Community Regulatory Board (ECRB) in its report “Prosumers in the Energy Community<sup>4</sup>” states that “self-consumption can assist in meeting renewable energy targets and assist in reducing network losses and peak loads, increase energy efficiency, improve demand response and consumer engagement as consumers can choose to produce part or all of the electricity for their own needs.

The new Renewable Directive (EU) 2018/2001 promotes and strengthens the development of RE Self-Consumption, however it is not yet transposed in the Energy Community acquis. Regardless, the Policy Guideline on Integration of Renewables Self-Consumers, PG 03/2020<sup>5</sup> adopted by the Energy Community Secretariat (EnCS) advises on the development of national legal and regulatory frameworks that enhance RE Self-Consumption and final customers’ active participation in the electricity market. It recommends to the CPs to take into account provisions of the new RES Directive already now, in anticipation that by mid-2021 the Energy Community will transpose it into the new Renewables Directive that will repeal the currently applicable Renewable Directive<sup>6</sup>.

Table I below provides descriptions and recommendations from the EnCS Policy Guidelines and our recommended specific actions for Kosovo, for each EnCS general recommendation.

The publicly available ERO database of self-consumption generators show there are 56 solar PV roof-top projects or 1,736.43 kW of installed capacity which benefit from the support scheme of net-metering.

In addition, during in-field research conducted in October-November 2020, 183 projects of 5,624.96kW were identified as behind-the-meter, without net metering installed capacity, mainly roof-tops. These projects are not reported to the ERO because they do not feed electricity into the grid and therefore do not have to apply to the ERO for authorization. The problem with not reporting these projects is that the installed capacity is not included in the RES national targets nor is it counted as electricity generated from solar PV. Ideally, these installations and the electricity produced would be reported to the ERO and MEE and be included in the national database. The most efficient way to accomplish this might be to require solar PV installers to track and report all solar PV installations. Since these are behind-the-meter installations, the installed capacity can be reported but the amount of electricity produced will be estimated.

---

<sup>4</sup> Prosumers in the Energy Community, Legal and regulatory framework for support and treatment of small-scale generators with Special focus on solar photovoltaic (PV) systems connected to the distribution network, ECRB, March 2020

<sup>5</sup> Policy Guideline on Integration of Renewables Self-Consumers PG 03/2020, EnCS, September 28, 2020

<sup>6</sup> Directive 2009/28/EC of the European Parliament and of the Council of 23 April 2009 on the promotion of the use of energy from renewable sources and amending and subsequently repealing Directives 2001/77/EC and 2003/30/EC

The first prosumer (net metering) solar PV project became operational in 2018. Market research conducted by KESS of solar PV installation firms show that there is potential for 250MW of rooftop solar PV installed capacity by 2030. Of the 250 MW capacity, 150MW is for businesses, 50MW is for households, and 40-50MW is for public sector buildings.

Kosovo is currently drafting its National Energy and Climate Plan (NECP) and is amending its Energy Strategy; a public consultation is estimated to take place in early 2021. It is expected that the NECP will include a target for renewable self-consumption, which will count towards the total national RES targets. It is also expected that the NECP will propose measures to promote the deployment of renewable self-consumption, and the reporting and tracking of renewable self-consumption installations and key performance indicators.

The Government of Kosovo should make the necessary amendments to the energy laws and/or pass a law on renewable energy. The relevant secondary legislation and administration instructions should be amended or replaced in conformity.

## RECOMMENDATIONS

**Table I Policy Framework Recommendations**

Recommendations by EnC	Description of EnC Recommendation	KESS Recommended Actions
Current status and potential for self-consumption deployment	The current status of deployment of renewable self-consumption, should be identified in the process of NECP development. The deployment potential should be calculated and used as an indicator in the process of target setting.	<ul style="list-style-type: none"> <li>• Ministry of Economy and Environment (MEE) to issue an administrative instruction that will oblige all developers and installers to report such capacities to MEE. The reporting obligation to be applicable for all types of solar PV installations, including behind-the-meter installations (with zero export) and off-grid projects supported via agricultural grants.</li> <li>• MEE to establish and maintain a database of all solar PV installations in the country.</li> <li>• MEE to keep track on potential projects and incorporate the potential self-consumption PV projects into national targets.</li> </ul>
Self-consumption targets	The contribution of self-consumption to national 2030 targets, taking into account the current status, potential, environmental and socio-economic aspects, technological development and the falling cost of investments into renewable energy sources, should be considered. The target should be clearly set, for instance as the share of roof-top PV capacity in the total national renewables target. Shares of self-consumption should count towards the calculation of the gross final consumption of electricity from renewable sources.	<ul style="list-style-type: none"> <li>• The Government to finalize the NECP and revise the Energy Strategy.</li> <li>• Both NECP and revised Energy Strategy shall include a share of renewable self-consumption projects in the calculation of the gross final consumption of electricity from RES.</li> <li>• The outlook of potential capacity identified by the business community shall be also considered.</li> </ul>

Recommendations by EnC	Description of EnC Recommendation	KESS Recommended Actions
Barriers to self-consumption deployment	An assessment of the main barriers (legal, administrative, regulatory, financial, technical, customer awareness, social acceptance, etc.) to the deployment of self-consumption should be done as a basis for the development of a legal and financial framework addressing the barriers and enabling the attainment of the set targets.	<ul style="list-style-type: none"> <li>• The Government of Kosovo should initiate amendment of the laws on energy and/or initiate development of new law on Renewable Energy Sources in order to enhance deployment of self-consumption.</li> <li>• ERO should initiate amendment of secondary legislation.</li> <li>• MED should replace the administrative instructions or amend them based on findings.</li> </ul>
Strategy for the development of self-consumption	A set of adequate policies and measures to remove the identified barriers, promote and facilitate the deployment of self-consumption in line with the objectives, including through financial support, should be defined and included into NECPs and promoted by other relevant strategies, i.e., strategies for long-term renovation and integration of renewable self-consumption in plans for the refurbishment of buildings into nearly zero-energy buildings.	<ul style="list-style-type: none"> <li>• A thorough assessment of financial and fiscal implications should take place before the work on final support scheme.</li> <li>• The new Energy Strategy shall give recommendations to integrate RE self-consumption as part of public building stock renovations as part of energy efficiency measures contributing to transforming these building to nearly zero-energy buildings.</li> </ul>
Progress Monitoring and reporting	In the context of reporting on NECP implementation, the Contracting Parties should monitor and report on the implementation of self-consumption targets, including key performance indicators which should be defined in a comprehensive manner.	<ul style="list-style-type: none"> <li>• MEE to develop the secondary legislation to formally establish a roadmap for monitoring and reporting of key performance indicators for implementation of renewable self-consumption targets.</li> </ul>

## LEGAL AND REGULATORY FRAMEWORK

### CURRENT STATUS

A major barrier to the development of RE self-consumption is a lack of national legal and regulatory framework that supports RE self-consumption and enables final customers to actively participate in the RES sector as a prosumer. The Policy Guidelines PG 03/2020 (the Policy Guidelines) states that the lack of a national legal and regulatory framework requires “amending the primary legislation governing renewable energy and the development of secondary acts that define in detail the procedures, terms and conditions for issues such as grid connection and market integration of self-consumption”.

The Law on Energy and other power sector related laws in Kosovo<sup>7</sup> do not define the RE self-consumers and do not address the procedure and conditions for their market integration. The reason for this is that the power sector laws were adopted in 2016, before the EU and Energy Community focused on the role of prosumers and their relevance for the sector.

Inclusion of prosumers in the primary legislation and secondary legislation will clarify details related to, in particular, procedures for obtaining RE self –consumers status, functions, responsibilities as well as terms and conditions of their performance and grid integration, and enhance private sector involvement and participation in the self- consumption schemes in RES.

ERO partially covered the RE self-consumption in the Rule on Support Scheme, which designates a support scheme for prosumers, and in the Rule on Authorization of New Generation Capacities for RES Generators (April 27, 2017) which delineate the authorization process applicable to prosumers. Other particulars relevant for the RE self-consumption are not included in any power sector legislation.

According to the Policy Guidelines the prosumers have to maintain their rights as final customers. These rights in Kosovo are stipulated in the Rule on General Conditions of Energy supply no. 12/2017, and include, inter alia, that the consumer shall:

- Be informed on their energy contracts and the right to withdraw from the contracts,
- Receive information on their consumption and to be billed based on this information,
- Receive information regarding energy efficiency measures and energy produced from renewable energy sources,
- Receive easy and efficient dispute resolution,
- Receive energy performance certificates for their homes,
- Get access to a single contact point for information purposes, and
- Be entitled to switch from one supplier to the others without any barrier or obstacle.

However, the Rule on General Conditions of Energy Supply does not explicitly extend to prosumers, which is required to ensure their rights as consumers.

The Policy Guidelines requires that the regulatory framework “provide precise definitions of consumer categories and their eligibility for self-consumption schemes”. For these purposes, households and

---

<sup>7</sup> Law No. 05/L – 081 on Energy, Law No.05/L-084 on the Energy Regulator and Law No. 05/L-085 on Electricity (all adopted on June 16, 2016)

small commercial consumers should be treated separately from industrial and large commercial consumers. The Policy Guidelines does not exclude industrial and large commercial customers from becoming a self-consumer, it only requires that these two categories be treated separately.

The Rule on Support Scheme limits renewable self-producer only to consumers connected to the low voltage distribution network; by doing so it hinders the commercial and industrial customers on medium and high voltage network to apply and become a prosumer.

The authorization procedures for self-consumption should be clear, simple, comprehensive, transparent, proportionate, and streamlined across different administrative levels and competent authorities, including through the establishment of single points of contact in the administration.

Even though the aim was to create a streamlined and simplified procedure, as explained in the Activity I Report, the process is complicated, without standardized requests and forms, particularly in relation to municipal consents, that each municipality grants in different forms that are often not publicly available.

Companies that applied for authorization for construction of new generation facilities (business community) during interviews declared that the DSO (KEDS) and the universal supplier (KESCO) have requested from them to make deep connection investments which, based on their opinion, is not necessary for the safety of the grid. That is, the KEDS requests specific relays and other investments which are raising the investment costs especially for household prosumer and increasing the overall cost of the project. Moreover, the procedure for obtaining the authorization from the ERO for construction of new capacities and receiving a prosumer status has a number of steps which require countless documents and long period for completion. ERO should review technical requirements imposed by KEDS on investors and evaluate if these requirements are applied in a transparent, non-discriminatory, and proportional manner.

Final consumers are not sufficiently informed on RE self-consumption scheme, accessibility and their rights and benefits as self-consumers. This is particularly applicable to KEDS and KESCO that do not publish any related information.

## RECOMMENDATIONS

**Table 2 Legal and Regulatory Framework Recommendations**

Recommendations by EnC	Description of EnC Recommendations	KESS Recommended Actions	Barrier
Renewable self-consumer activities, rights and obligations	A legal framework should explicitly allow a final customer to generate renewable electricity for its own consumption, to store and sell self-generated renewable electricity, provided that it is not its primary commercial or professional activity.	<p>Law No. 05/L – 081 on Energy, adopted in 2016 <b>does not recognize the renewable energy self-consumption</b>, and needs to be amended to include RE Self-consumption as recommended by the Policy Guidelines.</p> <p>Government of Kosovo have a choice to either:</p> <ul style="list-style-type: none"> <li>• Amend the Law on Energy, and/ or</li> <li>• Develop a new Law on Renewable Energy Sources to cover RES sector issues independently from other energy sector issues.</li> </ul> <p>Currently there is no law on renewable energy sources in Kosovo and RES issues are covered in the Law on Energy.</p> <ul style="list-style-type: none"> <li>• Amendments to the Law on Energy shall be introduced in articles related to: <ul style="list-style-type: none"> <li>✓ purpose of the Law (which shall be, between others, to establish the rules on self-consumption of RE),</li> <li>✓ scope of the law (to extend its scope to the RE self-consumption),</li> <li>✓ in definitions add: support scheme, renewables self-consumer, jointly acting renewables self-consumers, aggregators, RE community, and similar.</li> <li>✓ introduce the concepts of aggregation, jointly acting self-consumers and renewable energy communities, including their rights to benefit from national support schemes.</li> <li>✓ define that the Energy Strategy and Energy Strategy Implementation Program shall take into consideration RE self-consumption in overall national targets.</li> <li>✓ include RE self-consumers functions, responsibilities, and rights, as well as their grid connection and market integration</li> </ul> </li> </ul>	Legal

Recommendations by EnC	Description of EnC Recommendations	KESS Recommended Actions	Barrier
		<ul style="list-style-type: none"> <li>✓ permit for decentralized storage, enhance the development of connection and metering rules for consumers with installed Decentralized Generation units and</li> <li>✓ enhance principles of flexible tariff design adjusted timely to allow additional customer classes and effective billing and reporting systems.</li> </ul> <ul style="list-style-type: none"> <li>• After amendments of the Law on Energy and/or after adoption of the new Law on Renewable Energy Sources, the ERO shall amend the secondary legislation in order to explicitly recognize the right of the RE self-consumers.</li> <li>• Rule on General Conditions of Energy supply no. 12/2017, adopted by ERO in April 2017 shall extend to the RE self-consumers so that their rights as final customers are adequately protected.</li> </ul>	
Renewable self-consumer activities, rights and obligations	Renewable self-consumers should be explicitly entitled to keep their rights and obligations as final customers (e.g., supplier switching and protection measures).	<p>According to the Policy Guidelines the renewable self-consumers have to maintain their rights as final customers. These rights in Kosovo, specifically stipulated in the Rule on General Conditions of Energy supply that between others issue, include the rights of consumer to:</p> <ul style="list-style-type: none"> <li>• Be informed on their energy contracts and the right to withdraw from the contracts;</li> <li>• Receive information on their consumption and to be billed based on this information;</li> <li>• Receive information regarding energy efficiency measures and energy Produced from renewable energy sources;</li> <li>• Receive easy and efficient dispute resolution;</li> <li>• Receive energy performance certificates for their homes;</li> <li>• Get access to a single contact point for information purposes, and</li> <li>• Switch from one supplier to the others without any barrier or obstacle.</li> </ul> <p>However, the above-mentioned rights do not explicitly extend to renewable self-consumers, since the rule does not define renewable self-consumers, therefore it does not enhance the right they should enjoy as consumers.</p>	Regulatory



Recommendations by EnC	Description of EnC Recommendations	KESS Recommended Actions	Barrier
Non-discrimination	<p>The right to participate in renewable self-consumption schemes should be granted to all final customers, including through aggregators in a non-discriminatory and transparent manner. Any differentiation between different customer categories and between individual and jointly acting self-consumers has to be proportionate and duly justified.</p>	<ul style="list-style-type: none"> <li>Article 20 of the Rule on Support Scheme establishes that any electricity <b>customer connected to the low voltage distribution network</b> can apply to its Supplier to obtain the status of a prosumer. The reason for allowing only low voltage consumers to apply and become RE self-consumer, given by ERO during the interview with KESS team on November 12, 2020 is related to the fact that the majority of the consumers (household and small commercial consumers) are connected to the low voltage level. However, this is not sufficient for exclusion of other consumer categories from their right to benefit from the renewable self-consumption and national support scheme, of net metering<sup>8</sup>.</li> <li>Article 20 of the Rule on Support Scheme shall be amended to allow all consumers (regardless the voltage level) to apply for the RE self-consumption.</li> </ul>	Regulatory
Criteria and organization of self-consumers	<p>Precise definitions and criteria for self-customers to benefit from support schemes should be defined, including technical requirements such as installed capacity, voltage level and metering system at the connection point of self-consumers.</p> <p>The legal framework should allow renewable self-consumers to act individually or collectively through aggregation or as jointly acting self-consumers when located in the same building, including multi-apartment blocks.</p>	<ul style="list-style-type: none"> <li>ERO shall amend the Rule on Support Scheme for RES Generators to include full definition of renewable self-consumer in accordance with requirements from the Policy Guideline.</li> <li>Rule on Support Scheme define a prosumer as “an electricity customer who is at same time and at the same site the owner of a micro-RES generating facility, connected to the grid and having right to self-consume the generated electricity as well as to deliver the excess of generated electricity to the supplier”. Micro RES generating facility is facility connected to the network with a capacity up to 100 kW. The RE self-consumer’s definition is lacking provision that explicitly forbids the prosumer to sell electricity as his “primary commercial or professional activity”. In order to be a prosumer, a final customer, for example, cannot</li> </ul>	Regulatory

<sup>8</sup> “Net-metering” is a simple arrangement that ensures consumers that install a generator (usually photovoltaic (PV) systems) receive a one-for-one credit for any electricity their systems generate and export to the grid within a billing period. In this case, production and consumption are compensated over a longer period (up to one year). Under a net-metering scheme, all kWh of the generator are equally valorized.

Recommendations by EnC	Description of EnC Recommendations	KESS Recommended Actions	Barrier
		<p>be a trader; he should keep a position of a consumer, as required by the Policy Guideline.</p> <ul style="list-style-type: none"> <li>• Another important element that the definition of prosumer is lacking is a possibility of prosumer to store the self-generated electricity. Hence, renewable self-consumers should be explicitly allowed to store their generated electricity.</li> </ul>	
Administrative procedures	<p>Authorization procedures for self-consumption should be clear, simple, comprehensive, transparent, proportionate, streamlined across different administrative levels and competent authorities, including through the establishment of single points of contact in the administration.</p>	<ul style="list-style-type: none"> <li>• The Government of Kosovo shall activate One Stop Shop (OSS) to assume its full responsibility and proactively follow and enhance the RES investment projects. This obstacle is described in detail in Part 4 of this report as it applies to almost all RES generators.</li> <li>• If the simplification and streamlined processes is not introduced by institutions responsible for permit and licenses granting, the One Stop Shop may recommend modification.</li> </ul>	Administrative
Support schemes	<p>Instruments, schemes, and mechanism that could facilitate penetration and integration of self-consumption including through direct financial support to the investment, netting schemes, feed-in tariffs, reduction or exemption from taxes and levies, should be defined.</p> <p>Support schemes should be designed in a way that reflects long-term policy objectives. They should be provided on the basis of consistent and predictable framework in order to ensure stability and security of the investment. The legal framework should clearly define requirements which are to be met by the self-consumer's installation in order to benefit from an incentive. Support for the deployment of integrated renewables and energy storage equipment should be considered taking into account its long-term value to the grid, the environment/climate and society.</p>	<ul style="list-style-type: none"> <li>• National support schemes should be reviewed and modified in order to reflect the market changes; however, any change should be done in a non-retroactive manner, with a defined timeline and with a set of quotas which would better reflect a long-term policy and enhance investors' confidence.</li> </ul>	Legal

Recommendations by EnC	Description of EnC Recommendations	KESS Recommended Actions	Barrier
Cost reflectivity	The self-consumption regulatory framework should respect the principles of cost reflectivity, cost recovery and avoidance of cross-subsidization among network users. To the extent it applies to undertakings, it should comply with the relevant State aid rules.	<ul style="list-style-type: none"> <li>ERO shall develop and approve new Rule on RE self-consumption (or amend existing rules) to include Net-Billing<sup>9</sup> for large consumers, while Net-Metering could remain applicable for small customers and households. These arrangements shall be applicable during initial period that should be defined by ERO in related rules.</li> </ul>	Regulatory
Charges and fees	Renewable self-consumers should not be subject to discriminatory and disproportionate charges or fees.	<ul style="list-style-type: none"> <li>ERO shall review technical requirements imposed by KEDS on investors and evaluate if these requirements are applied in a transparent, non-discriminatory, and proportional manner.</li> <li>Regular monitoring by ERO shall ensure that the RE-self-consumers are not charged in excess and in a disproportional manner</li> </ul>	Regulatory
Access to information on self-consumption	Single points of contact should be established, and information published on the websites of national or local bodies responsible for promotion of renewables and energy efficiency, providing final customers with all the necessary information regarding their rights, obligations and potential benefits of becoming renewable self-consumers.	<ul style="list-style-type: none"> <li>Final consumers are not sufficiently informed on RE self-consumption scheme, accessibility and their rights and benefits as self-consumers. This is particularly applicable to KEDS and KESCO which do not publish any information in that respect.</li> <li>KESCO as a public supplier, and other suppliers, shall use all accessible means to inform consumers on their rights and responsibilities in relation to self-consumption, such as to use: information campaign, leaflets submitted to consumers together with their monthly invoices, web site information and through media.</li> </ul>	Administrative
Subsequent legislative changes	Subsequent legislative changes should not have retroactive impact on existing self-consumption schemes, including support schemes. The unit price	<ul style="list-style-type: none"> <li>Government of Kosovo and ERO should ensure that the amended or new legislation adopted to incorporate renewable self-consumption, contain the</li> </ul>	Legal and regulatory

<sup>9</sup> Net-billing is an arrangement by which the consumer receives one-for-one monetary credits for every kWh of exported to the grid. Every kWh is valorized either at a single price or at a price which corresponds to the time of production. Credits are awarded over a determined timeframe, typically one year. It is equivalent to a net-metering scheme, but with monetary compensation instead of energy compensation

Recommendations by EnC	Description of EnC Recommendations	KESS Recommended Actions	Barrier
	changes of excess energy, grid tariffs or other taxes and levies are not considered as a change of the legislative framework.	disposition that no retroactive effect will apply to already granted support schemes.	

## TECHNOLOGICAL AND TECHNICAL REQUIREMENTS

### CURRENT STATUS

From a technical and technological point of view, Kosovo's energy sector does not face limitations when it comes to the installation of all types of renewable technologies by self-consumers connected to the grid with net metering.

The relevant TSO and DSO grid and metering codes are allowing the connection upon fulfillment of the technical requirements specified in the codes. RES equipment to be installed must be in full compliance with the technical requirements of the Kosovo Standardization Agency and/or with relevant international standards, such as CENELEC, IEC, etc. It shall be noted, however, that it would be helpful for the DSO to disseminate a brochure specifying the requirements for connecting to the grid for net metering.

For the grid to accommodate significant new additional RES, there will need to be concomitant energy storage installed. The ERO and the DSO need to develop policies and procedures for energy storage such as utility scale battery storage (BESS) in order to facilitate energy storage installation and connection to the grid to stabilize the grid. Both KEDS and KOSTT have stated that there are not enough auxiliary services, reserves, balancing, etc., currently available. This is important for prosumers for their own back up, but even more important for large scale RES generators that are primarily selling to the grid.

In terms of connection, all self-consumption power (up to 100kW) generated from renewables are permitted to be connected to the grid at 0.4 kV level, while the connection rules for self-consumption generators shall be in line with the Network Code on Requirements for Grid Connection of Generators, respectfully "Regulation (EU) 2016/631 of April 14, 2016 Establishing a Network Code on Requirements for Grid Connection of Generators", which the CPs are obliged to implement by July 12, 2021. Network planning is undoubtedly a cornerstone for any future reliable development, and as such, it is crucial for the network development plan to consider RE self-consumers demand, which is not the case in the existing KEDS development plan 2020-2029. It is, therefore, imperative to work on identification of potential sites for self-consumers and relevant planning in accordance with TSO and DSO development plans. In addition, potential self-consumers should have full access to information concerning the network development plans and potential available capacities for their RES deployment.

According to the existing rules, the installed generation capacity should not exceed 100 kW, and generally consumers can install generating self-consumption capacities in compliance with energy consent (contracted capacity of the customer) issued by the DSO. However, the limitation set at 100 KW should be revised to allow for higher threshold for industrial purposes. In addition, capacity limitation for households and small consumers are based on their capacity and annual consumption, while the reference for the new connected consumer is the planned annual consumption, which should be taken into account.

In terms of smart metering systems for self-consumers there is a need to further develop and enhance the regulation for such a system pursuant to the Policy Guidelines of the Energy Community, which among others, shall clearly address costs and installation of smart meter by the prosumers. The current

DSO's connection procedures are complicated and should be streamlined and simplified. Draft DSO's Connection Charging Methodology is under review by ERO.

## RECOMMENDATIONS

**Table 3 Technological and Technical Requirements Recommendations**

Recommendations by EnC	Description of EnC Recommendation	KESS Recommended Actions
Renewable technology	All types of renewable technologies should be allowed to be installed, owned and operated by renewable self-consumers.	<ul style="list-style-type: none"> <li>• Distribution System Operator (KEDS) to prepare clear technical standards required for renewable technologies in the form of brochures or leaflets to be available for renewable self-consumers.</li> </ul>
Energy storage technology	Energy storage installations should be defined, including a more specific classification of their technical characteristics, including whether they are before or behind the meter. Renewable self-consumers should be allowed to install, own and operate energy storage installations.	<ul style="list-style-type: none"> <li>• The Law on Energy foresees the energy storages in Article 8, paragraph 10.4, as follows: “Mandatory components of long-term balances, as per paragraphs 4, 5 and 6 of this Article are the following: a list of required levels of storage and capacity reserves necessary for ensuring an appropriate level of planned supply sustainability (stability).</li> <li>• There are no legal and regulatory obstacles for installation of energy storage for RE self-consumers, however the energy law is silent in relation to self-consumption and the existing rules adopted by ERO does not cover operation and storage for self-consumption</li> <li>• TSO and DSO shall prepare and submit to ERO for approval technical characteristics for energy storage;</li> <li>• Prepare the outlook of installed energy storages, before and behind the meter for self-consumers.</li> <li>• Develop technical and regulatory framework for installation and operation of energy-storage by self-consumers.</li> </ul>
Voltage level	Renewable self-consumption, including with energy storages, should be explicitly allowed to be connected to all voltage levels in line with the connection rules.	<ul style="list-style-type: none"> <li>• Develop connection rules for self-consumption generators that are in line with the Network Code on Requirements for Grid Connection of Generators, which the Contracting Parties are obliged to implement by 12 July 2021.</li> </ul>
Network planning	As part of network planning, system operators should analyze how and where self-consumption and storage could best support the network.	<ul style="list-style-type: none"> <li>• Identify the potential sites for development of self-consumption;</li> <li>• Prepare the spatial planning for development of self-consumers based on TSOs and DSO Development plans;</li> <li>• Inform self-consumers with the network development plans and available network capacities for deploying self-generation capacities in transmission/distribution system.</li> </ul>

Recommendations by EnC	Description of EnC Recommendation	KESS Recommended Actions
Installed capacity criteria	As a general rule, the installed capacity eligible for self-consumption schemes shall not exceed the requested connected and/or contracted capacity of the customer.	<ul style="list-style-type: none"> <li>• Currently there is no method for determination the upper level of installed capacity eligible for self-consumption, but all customers that are connected to the low voltage (0.4 kV) network with a capacity up to 100 kW (<math>\leq 100</math> kW) have the right to become prosumer.</li> <li>• ERO shall amend the Rule on Support Scheme to include a provision that the installed capacity eligible for self-consumption should not exceed the requested connected and/or contracted capacity of the customer; right now, the limit of 100kW applies;</li> <li>• Capacity limit imposed by ERO at 100 kW is too low for some businesses. In Albania, for comparative purposes, the limit is 500 kW. If ERO increase this limit from 100 kW to at least 500 kW. It is estimated that the average capacity size will increase to about 100-125 kW if the cap is increased to 500 kW. It should be noted that in its Policy Guidelines 2020<sup>10</sup>, the Energy Community recommended that all renewable self-consumers with installations above 400 kW capacity shall be balancing responsible parties. Therefore the 400 kW may be the most appropriate capacity limit.</li> </ul>
Capacity limitation for energy storages combined with self-generation	Capacity limitations (consumption/injection level) for energy storage used in renewable self-consumption installations should be defined in a non-discriminatory manner, including limits for energy storages for small-scale applications.	<ul style="list-style-type: none"> <li>• Develop regulation for energy storage for self-consumers.</li> </ul>
Smart metering systems	Minimum functional and technical requirements for smart metering systems to allow renewable self-consumers to act individually or collectively should be adopted and published by system operators.	<ul style="list-style-type: none"> <li>• Develop regulation for Smart Metering Systems in compliance with recommendation of the Policy Guideline and in line with network and metering codes, or.</li> </ul>

<sup>10</sup> The limitation of 400kW capacity is based on Article 6 of the DIRECTIVE (EU) 2019/944 of the European Parliament and of the Council, of 5 June 2019 on Common Rules for the Internal Market for Electricity and amending Directive 2012/27/EU, that require balancing responsibility for all market participants, with exception of power-generating facilities using RES with an installed electricity capacity of less than 400 kW. However, the derogation grating to RES generators will be further reduced to less than 200 kW starting from January 1. 2026.



Recommendations by EnC	Description of EnC Recommendation	KESS Recommended Actions
	<p>At the connection point of self-consumers that feed electricity into the grid, system operators should ensure a bi-directional meter which registers separately electricity fed into the grid and electricity consumed from the grid.</p> <p>Smart metering systems should allow renewable self-consumers to be metered and settled in line with the imbalance settlement period (ISP) at the wholesale electricity market, as well as with the ISP requirements of the Guidelines for Electricity Balancing<sup>11</sup>, to facilitate an optimal utilization of self-consumption and energy storages in a way that ensures market efficiency and grid stability and to improve generation forecasts.</p>	<ul style="list-style-type: none"> <li>• Use the existing draft Connection Charges Methodology that KEDS developed and include elements of the regulation pertaining to smart meter system. The draft methodology that was prepared some time ago is awaiting approval of the ERO Board.</li> <li>• Self-generators pay the connection costs as all other customers.</li> </ul>
Customer right to smart meters	<p>Self-consumers should be entitled to smart meters in a non-discriminatory and transparent manner, either through a smart meter roll-out, or on request. The self-consumer should bear the costs of installing or upgrading the smart meter, in accordance with transparent, non-discriminatory, cost reflective and published rules, which define the terms, conditions and costs of connection.</p>	<ul style="list-style-type: none"> <li>• Regulation on Smart Metering System shall contain the procedure for installation of smart meters and shall be adopted by ERO and published.</li> </ul>
Connection procedure and DSO authorization	<p>A streamlined and simplified connection procedure should be established to shorten connection time and decrease administrative costs. Nevertheless, all technical and safety requirements for self-consumption installations must be fulfilled and a self-consumer's installation and connection must be subject to DSO authorization.</p>	<ul style="list-style-type: none"> <li>• ERO to adopt draft DSO's Connection Charging Methodology that was developed by KEDS and still awaiting ERO approval. This methodology is streamlined and simplified to incorporate renewable self-consumers and enhances a timely and cost-effective connection procedure.</li> </ul>

---

<sup>11</sup> Regulation (EU) 2017/2195 of 23 November 2017 establishing a guideline on electricity balancing [http://eur-lex.europa.eu/legal-content/EN/TXT/?uri=uriserv:OJ.L\\_.2017.312.01.0006.01.ENG&toc=OJ:L:2017:312:TOC](http://eur-lex.europa.eu/legal-content/EN/TXT/?uri=uriserv:OJ.L_.2017.312.01.0006.01.ENG&toc=OJ:L:2017:312:TOC)

## SELF-CONSUMPTION AND ACCESS TO THE MARKET

### CURRENT STATUS

The only support scheme for renewable electricity self-consumption in Kosovo is net-metering (two-way metering). With net-metering, the amount of energy consumed from the grid is balanced annually with the amount supplied back to the grid from excess renewable energy production. Any outstanding positive balance on the last billing period of a calendar year is reset to zero (0 kWh) without compensation from the supplier. However, the excess renewable energy produced (for example, during the day with solar PV) helps offset energy bought from the grid (for example, at night).

Net-metering is used widely worldwide. However, it often involves offsetting consumption with excess production on a kWh basis but not on a market price base for the transfer of electricity to the grid. The EU Energy Acquis requires that in order not to distort the market, more market-oriented mechanisms need to be used, with market prices paid both by the consumer for electricity bought and by the utility for electricity transferred to the grid by the consumer. Therefore, it is proposed that net-metering be used only for small-scale renewable self-consumption where the vast majority of electricity produced by RES is self-consumed by the consumer, and the net transfer of electricity to the grid is minimal.

Currently, in Kosovo, net-metering is authorized only for installations up to 100kW and connected to low voltage 0.4 kV network, and with an obligation on the universal supplier to conclude a prosumer agreement with the final customer, who also are in the balance group of the supplier. However, the legislation does not define the initial phase and the tenor for the net-metering authorization.

As pointed out earlier, no other netting schemes or any other support mechanism exists. Net metering should continue to apply for certain self-consumers, such as household and SMEs that transfer only small net amounts of electricity to the grid. Ideally, Kosovo would transition from net-metering only to net-billing, where electricity is bought and sold for respective tariffs. Kosovo has not yet implemented net-billing, but it may be proposed in the National Energy Climate Plan (NECP). It should be pointed out that Kosovo has never conducted a country-specific study to assess each potential support mechanism, examine how they may incentivize increased RES installation to help achieve the country's targets, and estimate the fiscal implications of such mechanisms to households, businesses, and the national budget.

The power sector would benefit from adoption of a law on renewable energy sources, with a specific section on self-consumption and include in a clear and simplified manner all the mechanisms and the applicable conditions, including net-metering, net-billing with pricing mechanisms, connection to the grid, etc. Introducing the jointly acting renewable self-consumers in such law would assist multi-apartment buildings to switch to renewable self-consumption, which would in turn enhance energy efficiency and contribute to RES targets. Peer-to-peer trading and aggregation should be explicitly recognized in the primary law.

Net-metering and net-billing self-consumers should be allowed to install capacities up to 400kW (up from the current 100kW cap) without having responsibility for balancing, as stated in the EC Directive. Installations over 400kW should take responsibility for balancing.

The ERO should then amend its Rules in order to harmonize them with the primary legislation.

## RECOMMENDATIONS

**Table 3 Self-Consumption and Access to the Market Recommendations**

Recommendations by EnC	Description of EnC Recommendation	KESS Recommended Actions
Remuneration schemes	<p>In general, remuneration should be based on separate accounting of electricity consumed from the grid and electricity fed into the grid. Prices should reflect the market value of electricity at the time when it is taken and injected into the grid.</p> <p>Support schemes, based on netting and feed-in tariffs, could be used to promote, and facilitate the deployment of small-scale renewable self-consumption in line with its potential and expected contribution to the achievement of decarbonization policy objectives and targets set by NECPs, taking into account their overall impact on the energy system and society. They should be approved by the domestic State aid authority in line with the Guidelines on State aid for environmental protection and energy 2014-2020. The decreasing costs of renewables and energy storage technologies should also be considered in support scheme design.</p>	<ul style="list-style-type: none"> <li>• In order to incorporate new support mechanism into the national legal framework, it is necessary to undertake a country-specific study which shall assess each support mechanism, provide a clear transitional period from one mechanism to another, and the conditions under which it can take place, and assess the fiscal implications that such mechanism might have to the national budget.</li> </ul>
Net metering scheme	<p>Net metering schemes should be available only as an incentive to boost small-scale renewable self-consumption during the initial phase of its deployment and for a limited period of time. Net metering could be limited to small installations up to a certain connected capacity (e.g., up to 30 kW). A certain level of total installed capacity from self-consumers after which net metering will not be granted could be defined. A deadline for self-consumers to switch from a net metering scheme to a scheme which accounts separately for the electricity fed into the grid should be defined by legislation. It is recommendable that, instead of net metering, support to small-scale renewable self-consumption is provided directly through feed-in tariffs, including for vulnerable and low-income customers.</p>	<ul style="list-style-type: none"> <li>• Net metering should continue to apply for certain self-consumers, like household and small businesses, however, for a transitional period of time, which will be defined by ERO.</li> <li>• In Kosovo there is only one active supplier that is at the same time licensed as universal supplier (KESCO), therefore the net-metering scheme contract has to be signed with KESCO under regulated prices and conditions.</li> </ul>

	<p>Terms and conditions, including electricity prices, shall be defined in the contract between a renewable self-consumer and the energy supplier.</p> <p>In case competition in the market is not yet developed, an obligation to conclude a contract with a self-consumer under the net metering scheme might be imposed on one or more suppliers (e.g., universal supplier). This should include regulated terms and conditions.</p>	
Net billing scheme	<p>To provide support to households and small customers, an obligation for suppliers to offer a net billing scheme to these customer categories could be defined by legislation. Terms and conditions may be regulated where necessary.</p> <p>In the initial phase, net billing could be permitted only for installations at the same location, i.e., connected to the grid via the same bidirectional electricity meter. In the second phase, the regulatory framework might allow net billing schemes for installations at different locations.</p>	<ul style="list-style-type: none"> <li>• Kosovo should introduce net billing for certain consumers categories and adopt specific rules on the net-billing scheme.</li> </ul>
Accounting and compensation in the case of netting schemes	<p>In case of netting, one month could be an optimal accounting period and one year could constitute an optimal credit compensation period. Any monetary credit surplus remaining after the annual compensation should be forfeited or subject to a special arrangement, offered by the off taker. In case of a decrease of energy consumption during the compensation period, whether due to force majeure or permanent (e.g., a factory is closed, or capacity decreased, changes in household demand, etc.), self-consumers should have the right to switch from a netting scheme to another remuneration mechanism offered in the market.</p>	<ul style="list-style-type: none"> <li>• Continue applying the same accounting and compensation rules for net-metering and introduce similar rules for net-billing in case the latter is introduced as a national support scheme.</li> </ul>
Dynamic pricing schemes and demand response	<p>Dynamic pricing schemes should be applied in order to incentive renewable self-consumers to optimally consume their renewable energy production and to provide maximum support to the grid, namely, to discharge batteries during peak demand periods (as opposed to discharging as soon as the renewable generation drops below self-consumer demand). Feeding electricity into the grid at times of high wholesale electricity prices would allow self-consumers to maximize their revenue, while providing support to the system in periods of peak</p>	<ul style="list-style-type: none"> <li>• Develop regulation for optimization of energy from renewable self-consumers, including demand response.</li> <li>• The developed regulation should give clear financial signals to renewables self-consumers of their benefits when feeding energy to the grid during peak demand periods.</li> </ul>

	<p>demand.</p> <p>Demand response should be supported to further increase system flexibility, facilitate the optimal and responsive integration of small renewable installations of self-consumers and lower the need for backup electricity generation capacity.</p>	
Jointly acting renewable self-consumers	<p>The emergence of jointly acting renewable self-consumers should be facilitated and supported. In a multi-apartment building, jointly acting renewable self-consumers could be established based on an agreement by the majority of final customers. Metering points of joint consumption (e.g., joint premises, elevators) could also be included into jointly acting renewable self-consumption.</p>	<ul style="list-style-type: none"> <li>• The concept should be incorporated. Implementation will commence after amendment of the legal framework.</li> </ul>
Peer-to-peer trading	<p>Peer-to-peer trading should be explicitly allowed by legislation. The development of pilot projects demonstrating the benefits for self-consumers and other involved market players, such as aggregators, should be supported.</p>	<ul style="list-style-type: none"> <li>• The incorporation of this concept should take place and the implementation will commence after the legal framework is amended.</li> </ul>
Energy services business model	<p>Energy business model should be promoted for integrated renewable and energy efficiency investments (especially related to buildings sector) with an involvement of the renewable self-consumers.</p>	<ul style="list-style-type: none"> <li>• The incorporation of this concept should take place and implementation will commence after the legal framework is amended.</li> </ul>
Supplier switching	<p>When supplier switching occurs under a netting scheme, the final settlement should include the value of the outstanding energy or the monetary credit or debit.</p>	<ul style="list-style-type: none"> <li>• There is currently only one active supplier (KEDS) despite the fact that seven other suppliers are licensed by ERO.</li> <li>• The legal framework should foresee supplier switching under netting schemes, and clearly point out all the rights and obligations of both parties (self-consumers and suppliers).</li> </ul>
Balance responsibility	<p>Self-consumers with installed capacity of 400 kW may be exempted from balance responsibility.</p> <p>Self-consumers with installed capacity of 400 kW and more should be balance responsible and have the right to delegate its responsibility to a balance responsible party of their choice.</p> <p>Renewable self-consumers that are subject to a netting scheme should be in the balance group of their supplier.</p>	<ul style="list-style-type: none"> <li>• Balancing responsibility should not apply for installations up to 400 kW, especially not for households and small businesses.</li> </ul>

<p>Access to metering data</p>	<p>System operators shall provide the metering data necessary for the settlement of commercial arrangements under a self-consumption scheme to the renewable self-consumer and its supplier at no additional cost.</p>	<ul style="list-style-type: none"> <li>• Metering data necessary for settlement of commercial arrangements under a self-consumption scheme shall be provided at no additional cost.</li> </ul>
--------------------------------	--	--

## **SELF-CONSUMPTION AND ACCESS TO THE NETWORK**

### **CURRENT STATUS**

In Kosovo there are no specific network charges established for prosumers. The prosumer only pays for the excess of electricity they consume over the amount of their self-production, netted out over the year. If on net basis they transfer more electricity to the grid than they take, they are not paid for the difference. It is therefore important to prepare the regulation for net-billing in compliance with EC guidelines and regulations.

It is also important to draft and adopt the regulation for the specific network tariffs for prosumers, including the tariff the universal supplier will pay the prosumer for the excess electricity it sells to the grid. Tariffs are also required for prosumers with energy storage systems such as battery storage.

The impact of self-consumption and prosumer on the stability of the network and grid should be carefully analyzed. An impact analysis has been initiated, including with support from the World Bank. Upon finalization of the impact analysis, the outputs shall be presented and submitted to ERO in order to determine final network charges as well as necessary auxiliary services.

## RECOMMENDATIONS

**Table 4 Self-Consumption and Access to the Network**

Recommendations by EnC	Description of EnC Recommendations	KESS Recommended Actions
General	<p>Network charges for renewable self-consumption shall be non-discriminatory, transparent, proportionate and cost reflective. Renewable self-consumers shall contribute in a balanced and adequate way to the sharing of overall costs of the system.</p> <p>The tariff system for access and use of the network shall be designed in a way that incentivizes self-consumers to optimally use the electricity, including through the usage of energy storage, and thus support the network.</p> <p>Full recovery of the network costs should be ensured even with the increasing number of self-consumers connected to the system.</p>	<ul style="list-style-type: none"> <li>• If necessary, net metering may be used during the transitional phase and limited to small scale residential (households) and commercial consumers, with yearly system quota.</li> <li>• Prepare the regulation for net-billing in compliance with EC guidelines and regulation.</li> </ul>
Network tariffs in the case of the net-metering scheme	<p>In the case of the net-metering scheme, used to support the uptake of self-consumption in an initial phase of its development, network charge netting electricity consumed from the grid and fed into the grid, should reflect the inherent capacity costs.</p>	<ul style="list-style-type: none"> <li>• Prepare and adopt the regulation to reflect the inherent capacity costs in network charges.</li> </ul>
Network tariffs for self-consumers	<p>Specific tariffs for self-consumers, as a separate subclass(es) of network users, should be designed to incentivize self-consumption to maximize support to the grid on the one hand, and mitigate risks related to cost reflectivity and cost recovery on the other.</p> <p>The use of network tariffs for self-consumption should consist of a capacity component in addition to the energy component. The weight of the tariff component based on capacity costs in the total grid costs should reflect fixed network and system costs to deliver the requested capacity at the self-consumer's connection point. The costs expressed in volumetric tariffs should be allocated over specify time intervals to reflect the contribution of the self-consumers to the peak demand.</p>	<ul style="list-style-type: none"> <li>• Prepare and adopt regulation of network tariffs for self-consumers or amend existing pricing methodologies to define the use of network tariffs for self-consumption pursuant the EC guidelines and regulation.</li> </ul>



Recommendations by EnC	Description of EnC Recommendations	KESS Recommended Actions
Grid tariffs for self-consumers with storage systems	<p>Network tariffs for self-consumers with energy storage installations should factor in the long-term support that energy storage provides to the grid. To design grid tariffs for self-consumers with integrated storage systems in a cost reflective manner, demand analyses are needed to determine whether self-consumers have a different load profile and lower peak demand in comparison to self-consumers without storage systems and other non-producing consumers of the same category. A reasonable assumption is that the self-consumers with a storage system have lower peak demand and/or feed-in capacity as a result of enhanced demand side response.</p> <p>A self-consumer with an energy storage installation shall not be subject to double charging, including network charges for stored electricity remaining within their premises.</p>	<ul style="list-style-type: none"> <li>• The regulation for network tariffs will cover self-consumers with storage systems.</li> <li>• The regulation should follow the policy guidelines of EnCS and EC applicable regulation</li> </ul>
Self-consumption impact on the network	<p>The system operator should analyze the impact of self-consumption on system operation and the revenue and report to the competent authorities (ministries, NRAs).</p>	<ul style="list-style-type: none"> <li>• Complete the ongoing studies supported by the World Bank and implement recommendations.</li> <li>• System operator should submit analysis to ERO on impacts of self-consumers on utility revenues and request network charges to “compensate” for “losses” as a result of self-consumption but avoid compensation from customers without self-generation.</li> </ul>

## CHARGES, TAXES AND LEVIES

### CURRENT STATUS

Renewables prosumers are not exempted from any charges or taxes. Prosumers pay the entire VAT amount of 18% for the PV solar system equipment, including project development and installation. The only reduced VAT is for electricity consumption amounting to 8%, however, this reduction is applied for all customers in Kosovo.

In connection to the VAT on the PV solar system, the in-field research has shown that this is a barrier to installation, especially in the household sector. An exemption from VAT would incentivize increased household installation of renewable self-generation. An in-depth study on the fiscal implications of reducing or eliminating VAT is required. Similarly, there is a lack of studies on fiscal impacts of mechanisms like netting schemes. Policy and legislative changes cannot be judiciously made without undertaking Kosovo-specific studies.

Lastly, it is important to promote and foster self-consumption by households and small commercial consumers by not applying charges, taxes and levies, especially when the generated energy is for self-consumption and not injected into the grid. Any charges, taxes and levies applied should be for specific grid services and clearly defined.

## RECOMMENDATIONS

**Table 5 VAT and other Taxes and Levies Recommendations**

Recommendations by EnC	Description of EnCS Recommendations	KESS Recommended Actions
General	Renewable self-consumers should not be subject to discriminatory and disproportionate charges, taxes, and levies, but also not be entirely exempted from their payment.	<ul style="list-style-type: none"> <li>Renewable self-consumption consumed within the same premises and not injected into the grid shall be exempted from any charges, taxes, and levies, unless it is necessary and unavoidable and implemented in a specific and time-define manner and based on substantiated reasons.</li> </ul>
Exemptions	<p>Any exemption of renewable self-consumption from charges, taxes and levies should be subject to a consistent, in-depth assessment of the impact of self-consumption on public revenues and on the contribution self-consumers make to specific policy objectives. For commercial self-consumers, exemptions should be in line with State aid rules.</p> <p>The impact assessment of the self-consumption schemes on public revenues should take into account different taxes: VAT on electricity consumption or similar consumption taxes, but also VAT on the CAPEX investment (non-taxable person's self-consumption systems) and OPEX costs, corporate income tax for the installation company, OPEX related taxes, insurance taxes etc.</p>	<ul style="list-style-type: none"> <li>An in-depth national assessment should take place in order to assess the possibility of exempting self-consumers from VAT tax applicable on PV system. The assessment should evaluate the fiscal implications of national support schemes.</li> <li>Financing for household solar PV systems has been extremely limited in Kosovo. Removing the VAT on household installations would increase the affordability and facilitate an increase in household utilization of solar PV.</li> <li>Solar installers in Kosovo have proposed an exemption from VAT for household solar installations. The total project costs for households are considerably higher per kW production capacity than larger projects due to the small scale. This reduces the affordability and bankability of the projects.</li> </ul>
VAT (Value Added Tax)	VAT legislation should not be rigid in order to prevent invoicing based on the net difference between energy delivery and injection, thus allowing small customers and the whole system to exploit energy, environmental and social benefits accrued from properly designed self-consumption schemes.	<ul style="list-style-type: none"> <li>The VAT legislation should be assessed for future applicability of Net-billing to households.</li> <li>If other support schemes are to be implemented, a review and potential modification of the VAT law shall take place.</li> </ul>

## **PART 2. LARGE SOLAR PV GENERATORS (UNSOLICITED)**

### **CURRENT STATUS**

This part describes the barriers identified by businesses which developed and implemented large scale projects, previously supported by feed-in-tariff.

The main obstacle identified with regards to unsolicited generators is the lack of harmonization of different legal acts and the complexity of the process which impacts investors in the process of receiving authorization to construct RES installations. For example, while the PPA for solar PV projects is for 12 years, the environmental permit for operation, in accordance with the Law on Environmental Protection, is issued only for a five-year period. The duration of the environmental permit should be extended to match the tenor of the PPA.

The PPA is not guaranteed by the government either for the offtake revenues, price stability or policy and regulatory changes over the tenor of the PPA. This impedes the ability of banks to provide financing on a non-recourse basis and requires collateral which limits the capacity of project sponsors to invest in additional projects. Also, the ERO approved PPA is non-negotiable.

On December 10, 2020, ERO issued a Decision to abolish the feed-in tariff regime. With this decision, there is no pricing mechanism in place for new projects. The ERO should soon take a decision on a new pricing methodology for such projects, which is competitive yet remunerative to project developers. The pricing methodology could be based on a reference price or be discovered through a competitive market-based tender or auction process.

The administrative process for approvals from the MEE and concerned municipalities is long and causes delays. In some cases, as reported by the companies that obtained authorization by the ERO, the delay in obtaining an environmental permit was longer than six (6) months. The companies reported that none of them received any services from the “One Stop Shop”, which seems to be inactive.

For the grid to accommodate significant new additional RES, additional ancillary services may be needed to stabilize grid operations. Policies, procedures, and grid codes should be developed to connect and integrate RES into the grid, install energy storage systems, and develop a market for ancillary services. This is important for development of large-scale RES generators that are selling to the grid<sup>12</sup>. Businesses have reported difficulties in getting connected to the grid through KEDS. In some cases, KEDS has required the RES developers to make significant investments to connect to the grid. A clear policy and standardized grid connection agreement is needed to provide guidance on grid connection for RES and clarify the obligations and costs to be incurred by the developer and the grid operator/owner. The draft connection methodology awaiting approval by ERO will hopefully provide clarity on this issue.

Integrating unsolicited RE generation into the grid could be a challenge; planning for RES project sites and capacity addition should be integrated with expansion plans of the TSO and DSO. Potential

---

<sup>12</sup> Applicable to both: solicited and unsolicited generators

developers should be provided access to generation and grid expansion plans of the utilities or market operator to facilitate project development.

## RECOMMENDATIONS

**Table 6 Barriers and Recommendations for unsolicited generators**

Specific Barrier	Description of Barrier	KESS Recommended Actions	Type of Barrier
Unharmonized legal framework	Different laws applicable to RES projects provide different duration of permits. While the PPA is signed for 12 years for solar PV, the environmental permit for operation, in accordance with the Law on Environmental Protection No. 03/L-025, of February 26, 2009, is issued for a five-year period. This mismatch creates uncertainty for developers since the environmental permit for the project does not cover the life of the PPA.	<ul style="list-style-type: none"> <li>The Law on Environmental Protection (No.03/L-025) shall be amended to extend validity of environmental permit to cover PPA duration.</li> </ul>	Legal
Duration of PPA	Under the Rule on Support Scheme, PPA for RES generating facilities under the regulated framework shall have maximum duration that is equal to the validity period of the RES Operators generation license issued by ERO. Should the RES Operator not be required to obtain a generation license, the duration of the Power Purchase Agreement shall be limited to a maximum of 15 years.	<ul style="list-style-type: none"> <li>Current solar PV technology has a useful lifetime of 20 to 25 years. Longer tenor PPAs of 20-25 years should be considered to lower the tariff.</li> </ul>	Regulatory
Unclear pricing mechanism for RES projects	<p>To date, six projects totaling 10 MW are operational in Kosovo through the Support Scheme. Each of these projects was contracted under the former feed-in tariff level of 136.4 EUR/MWh. All projects have capacity of 3 MW or less and have a 12-year PPA.</p> <p>In order to procure additional capacity, ERO on November 27, 2019 issued a Decision V-1204/2019 to increase the capacity eligible for the Support Scheme by 20 MW. Projects would be provided a 12-year PPA with Feed-in tariff of 85.5 EUR/MWh. These additional 20 MW of projects are pending a court decision and the State Aid Commission on November 24, 2020 assessed that the feed-in tariffs from the ERO Decision V-1204/2019 is</p>	<ul style="list-style-type: none"> <li>ERO should soon decide on a pricing methodology for new projects to be developed under the ERO's decision to increase capacity under the Support Scheme.</li> </ul>	Regulatory

Specific Barrier	Description of Barrier	KESS Recommended Actions	Type of Barrier
	<p>considered a state aid in accordance with the Law on State Aid No. 05/L-100 and as such the Commission has not authorization its implementation.</p> <p>An additional eight project applications received Preliminary Authorization but are now suspended, and another 28 pending applications are in the queue. However, on December 10, 2020 ERO decided to end the feed-in-tariff support scheme.</p> <p>The viability and bankability of new projects depend on the pricing methodology to be adopted in place of feed-in tariff and on the new PPA. ERO has developed a Methodology on calculation of a Reference Price for Energy generated from Renewable Sources, but the new methodology has not yet been adopted.</p>		
Prolonged procedure and social acceptance	Interviews with developers (companies that applied for authorization for construction of new PV generators) indicated that there are procedural delays in obtaining authorization from the Ministry of Environment and Spatial Planning (currently MEE).	<ul style="list-style-type: none"> <li>One-stop shop (OSS) services should ensure clear procedures with timely approvals,</li> <li>Awareness raising and social campaigns are required to disseminate information on the benefits of renewable energy to gain social acceptance.</li> </ul>	Administrative
Policy and procedure for energy storage	<p>For the grid to accommodate significant new additional RES, it may be necessary to install energy storage in order to stabilize the grid operations. Currently no procedure or policy exists to address energy storage.</p> <p>Both KEDS and KOSTT have stated that adequate reserves, balancing mechanism and auxiliary services are not currently available. This is important for the development of large-scale RES generators<sup>13</sup> that are primarily selling to the grid</p>	<ul style="list-style-type: none"> <li>The ERO and the DSO need to develop policies and procedures for energy storage such as utility scale battery storage (BESS), and develop a market for ancillary services to facilitate integration of large-scale RES into the grid.</li> </ul>	Regulatory/ Technical

---

<sup>13</sup> Applicable to both: solicited and unsolicited generators

Specific Barrier	Description of Barrier	KESS Recommended Actions	Type of Barrier
Identification of full potential sites in network planning documents and access to information	Current TSO and DSO development plans do not consider potential sites and capacities for new RES development. Network planning studies are also not available to project developers. This could lead to inoptimal planning and high costs for connecting new RES into the grid.	<ul style="list-style-type: none"> <li>Siting and sizing of new solar PV/RES should be coordinated with TSO and DSO expansion plans.</li> <li>Project developers should be provided information on generation and transmission expansion plans developed by the utilities and/or market operator.</li> </ul>	Regulatory/ Technical
Simple notification procedure for grid connection	<p>Article 17 of the EU Directive 2018/2001 requires establishment of a simple-notification procedure for grid connections whereby installations or aggregated production units of renewables self-consumers and demonstration projects, with an electrical capacity of 10,8 kW or less, or equivalent for connections other than three-phase connections, are to be connected to the grid following a notification to the distribution system operator.</p> <p>Within a limited period following the notification, DOS may reject the requested grid connection or propose an alternative grid connection point based on justified safety concerns or technical incompatibility of the system components. In the case of a positive decision by the DSO, or in the absence of a decision by the distribution system operator <b>within one month following the notification</b>, the installation or aggregated production unit may be connected.</p>	<ul style="list-style-type: none"> <li>Consistent with the EU Directive, the Law on Energy Regulator should be amended to include simple notification procedure for grid connections and include a deadline of one month for approval of connection.</li> <li>Amendment of the law will need to follow with modification of the Rule on authorization to include the relevant disposition.</li> <li>KEDS to implement the simple notification procedure for grid connection.</li> </ul>	Legal/Regulatory
Municipal consent form and delays in obtaining consent	<p>Instead of using one standardized form, each municipality uses different forms to provide municipal consent.</p> <p>Obtaining municipal consent is causing delays in project approvals for solar PV installations.</p>	<ul style="list-style-type: none"> <li>The municipalities shall develop and use a standardized form of consent that should contain the same elements for each municipality. This will provide certainty to the application process.</li> <li>Publishing the form on a website with electronic filing will further improve the application process and help reduce time for approvals.</li> </ul>	Administrative



Specific Barrier	Description of Barrier	KESS Recommended Actions	Type of Barrier
Capacity of Municipal personnel	The business community noted that municipal personnel are often inadequately trained and not sufficiently experienced to assist investors in the administrative process of obtaining licenses, permits and other approvals.	<ul style="list-style-type: none"> <li>Capacity building and training programs should be offered for municipal staff so that they benefit from the best practices and support investors.</li> </ul>	Administrative
Organization and duration of the permit-granting process	<p>EU Directive 14 sets forth the organization and duration of the permit – granting process through requirement that the entire administrative permit application and granting process shall not exceed two years for power plants, with possibility for extension up to one year in cases where duly justified on the grounds of extraordinary circumstances.</p> <p>The permit-granting process shall not exceed one year for installations with an electrical capacity of less than 150 kW, with possibility of additional up to one-year extension where duly justified on the grounds of extraordinary circumstances. Limitation of duration in the permit – granting process to two years require that the Government designate authority/ies that will be responsible to keep track on complete duration of authorization process, including construction and connection to network.</p> <p>ERO tracks the duration of the authorization procedure from the moment when the applicant submits an application to ERO. But the time required by applicants to obtain other required approvals and permits prior to submission of the application to the ERO is not captured and registered.</p>	<ul style="list-style-type: none"> <li>ERO should capture and register the entire duration for applicants to obtain approvals including the time for any approvals, permits and licenses required prior to submission of an application to the ERO.</li> <li>The entire duration for approvals will have to conform to Article 16 of Directive (EU) 2018/2001 when it is transposed in the Energy Community acqui and in the national legislation.</li> </ul>	Legal/Regulatory
Un-Defined requirements for documents during the Authorization Process	Article 7 of the Rule on Authorization procedure describes the application process for authorization of new large-scale and small-scale generators and lists the documents that the applicant shall submit to ERO. Some of the listed documents are not specified as to which exact document is required to be submitted or who is responsible to issue such documents. Lack of clarity in documents to be submitted with the application presents an obstacle to investors. For example, Article 7, paragraph 3 (point 3.9) of the	<ul style="list-style-type: none"> <li>Applicant for authorization should be provided clear instructions on documents to be submitted and the authorities to issue such documents.</li> </ul>	Regulatory

<sup>14</sup> Article 16 of the Directive (EU) 2018/2001 on the promotion of the use of energy from renewable sources

Specific Barrier	Description of Barrier	KESS Recommended Actions	Type of Barrier
	<p>Rule on Authorization require that the applicant for authorization shall submit: "...evidence by relevant authorities that confirm that the applicant has fulfilled all applicable requirements in accordance with relevant legislation in Kosovo (depending on the project), including the right on the use of land, where required." It is unclear which authority shall provide such evidence.</p>		
<p>Unclear requirements for documents during the authorization Process</p>	<p>Article 15.1 of the Rule on Authorization contain contradictory and unclear disposition related to applicants who have already obtained preliminary authorization from ERO and apply for conversion of the preliminary authorization to final authorization. The applicant is required to submit, amongst others: "all evidence in accordance to Article 7 which were submitted, or should have been submitted, with the application when the Decision on Preliminary Authorization was issued". It is unclear why the applicant needs to re-submit documents that were previously submitted and were the basis for ERO to grant a preliminary authorization.</p>	<ul style="list-style-type: none"> <li>Article 15.1 of the Rule on Authorization should be modified to delete requirement for re-submitting documents that were previously submitted to ERO to obtain preliminary authorization. (ERO may require resubmission of document that may have expired).</li> </ul>	<p>Regulatory</p>

## **PART 3. LARGE SOLAR PV GENERATORS BASED ON SOLICITED (TENDER OR AUCTION) PROCEDURES**

### **CURRENT STATUS**

Large utility scale solar PV projects above 3 MW are yet to be developed in Kosovo. KEK is planning to develop a 100 MW solar PV farm at the site of former TPP Kosovo A ash dump and former “Dragodan” overburden dump. A preliminary project feasibility study has been developed for KEK. Others, including the IFC, are planning to support large solar PV farms in the range of 50 MW.

As already stated in Annex 2, financing of large solicited solar PV projects can be done through different financing structures including public finance, grant financing, equity financing, corporate or balance sheet financing, and project finance based on the project and financing structure.

The terms and conditions for the sale of electricity from solicited generators to KOSTT, the Market Operator, would be covered in a negotiated PPA. RES generators could alternatively choose to sell electricity in the open market at market determined prices without a PPA. The ERO is developing an auction process to competitively procure electricity from large renewable energy projects with support from the EBRD.

Financing large utility scale solar PV projects in Kosovo face many barriers which will need to be addressed. Key barriers include the political, policy, and off-taker risks perceived by lenders and project sponsors. Some of these risks include counter-party credit risk posed by the weak creditworthiness of public sector off-takers such as KOSTT, policy and political risks related to change in policies, taxes, royalties, etc. which may impact project revenues, and business interruption risks which may impact power generation and project revenues. Variable interest rates and non-Euro financing could also be a risk depending on the lenders to the project. The impact of these barriers will be to increase the risk premium on the cost of capital making the project more expensive and increase the tariff.

Development Financial Institutions (DFIs) have guarantee instruments to mitigate some of the risks, but the GoK may have to indemnify the DFI through a sovereign guarantee. A sovereign guarantee is a contingent liability for the government, which could limit its borrowing capacity. Guarantees without a counter guarantee would generally be more expensive. Regardless, guarantees add to the cost of financing the project and increase the tariff.

There could be other technical, policy and regulatory barriers to large utility scale solar PV projects that have not yet been fully examined since such projects have not yet been developed in Kosovo. However, the development and operation of large wind farms provide assurance that barriers can be overcome, and risks mitigated through appropriate mechanism and instruments.

## RECOMMENDATIONS

**Table 7 Barriers and Recommendations for solicited generators**

Specific barrier	Description of barrier	KESS Recommended Actions	Type of barrier
Project Documents	<p>Project sponsors need a strong, enforceable, and aligned set of project documents (e.g., PPA, Implementation Agreement, and Grid Connection Agreement) to obtain financing, service the debt, and meet operational and maintenance costs.</p> <p>The terms and conditions of the PPA, the implementation and grid connection agreements and contracts will be critical to the bankability of projects, and project risks will need to be mitigated with appropriate instruments.</p>	<ul style="list-style-type: none"> <li>Standardized project documents should be developed to procure energy competitively and transparently from large solar PV projects.</li> <li>Document should be of internationally accepted standards and should be developed in consultation with all stakeholders.</li> </ul>	Legal/ Regulatory/Administrative
Tender or auction process	<p>Unsolicited projects and lack of transparency in the bid process will hurt investor confidence and not invite interest and submissions from credible project sponsors.</p>	<ul style="list-style-type: none"> <li>Develop standardized tender or auction procedures with standardized bid documents and submission processes.</li> <li>Develop transparent bid evaluation procedures</li> </ul>	Legal/ Regulatory/ Administrative
Financial risks to project development	<p>Political, policy, and off-taker risks perceived by lenders and project sponsors will impact project development, financing for projects and the tariff. Credit risk posed by the off-taker KOSTT, policy and political risks related to change in policies, taxes, royalties, etc., and business interruption risks will impact project revenues. Lending in non-Euro currency (such as US dollar financing from DFC) will pose a currency risk since project revenues are in Euro's.</p> <p>The impact of barriers will be to increase the risk premium on the cost of capital making the project more expensive and increase the tariff.</p>	<ul style="list-style-type: none"> <li>Inclusion of DFIs in the financing syndicate helps lower the perception of risk and crowds in commercial financing.</li> <li>Risk mitigation instruments from DFI and other instruments from Export Credit Agencies, and commercial insurance should be explored to mitigate project risks.</li> <li>GoK should consider the need to provide sovereign counter guarantees to guarantee instruments provided by DFIs. An analysis of the total amount of counter guarantees that GoK can provide to large RE projects should be undertaken.</li> </ul>	Legal/Regulatory/ Financial

Specific barrier	Description of barrier	KESS Recommended Actions	Type of barrier
		<ul style="list-style-type: none"> <li>• Liquidity guarantee through Letters of Credit from banks should be considered to guarantee PPA payments from KOSTT for a period of three to six months. Escrow accounts to cover PPA obligations should also be considered.</li> <li>• The potential to export power from Kosovo to regional countries, and the recent agreement to participate in the common electricity market should be examined since it reduces the dependence on a single off-taker.</li> </ul>	

## **PART 4. OTHER BARRIERS (applicable to all generators)**

### **CURRENT STATUS**

This part of the report focuses on the barriers applicable to all solar PV projects. The recommended actions shall assist in overcoming such barriers.

An obstacle not addressed in this report is the relatively large number of illegally connected consumers that cannot obtain municipal consent, and therefore not become prosumers. There are over 350,000 buildings that were built without permits and are currently illegal or going through the process of legalization.

Most of the barriers included in this part of report are related to the lack of implementation of already existing legal bases (laws or regulations). There are several examples of this kind of barriers:

- 1) Limited use of public tendering processes, Government is not using tendering procedure envisaged in law on energy regulator as a mean of purchasing new RES generation capacity;
- 2) The One Stop Shop (OSS) for RES projects is established through regulation on establishment of OSS is existing but not active;
- 3) Certificates of Origin are not implemented since ERO did not established a register and electronic form of certificate;
- 4) Simplified procedure introduced in all institutions involved in granting licenses or permits, as per the Administrative Instruction No. 06/2017 On Utilization and Support of Energy Generation from Renewable Sources (August 7, 2017)

ERO shall consider the necessity of the ERO Board to be responsible for approval of renewable self-consumers and should modify the rules to allow them to apply directly to the DSO (KEDS), as it is the case in most CPs to the Energy Community. In the absence of the feed-in tariff, that is abolished by the ERO Decision of December 10, 2020 and reference prices, which is still not approved by the ERO, it is recommended that the ERO consider mechanisms to funds the Renewable Energy Fund and to define the support scheme and methodology to be applied to the new RES developers.

The other barriers relate to full compliance with EU Directives; currently all energy sector laws are only partially compliant with EU Directives, which presents an obstacle for further development of the sector since developers cannot consider options that would have been available with full transposition of EC Directives.

Definition of overall targets for the share of energy from RES should not be incorporated in numerical value (for e.g. 25%) in the law on energy since every modification to the overall target would require a modification to the law.

## RECOMMENDATIONS

**Table 8 Other Barriers and Recommendations**

Specific barrier	Description of barrier	KESS Recommended Actions	Type of barrier
<p>Limited use of public tendering processes</p>	<p>Law on Energy Regulator No. 05/L-084 adopted on June 16, 2016<sup>15</sup> establishes that the construction of new generation capacities shall be undertaken either through authorization procedures implemented by ERO in compliance with Article 43 of the law, or through a tendering procedure by the Government in accordance with Article 44 of the law.</p> <p>So far ERO used the authorization procedure for all RES generating units built in the last several years, actually from 2015, meaning that the investors themselves were selecting sites for building RES facilities and applying for authorization to ERO. The Government as the owner of public sites shall be most competent authority to select best sites that may be tendered in order to increase security of supply that is a long-term problem in Kosovo.</p> <p>Article 44 of the law is stating that the Government may launch a tendering procedure for the construction of new generation capacities if ERO issues a written decision that the authorization procedure has not resulted successfully in either:</p> <ul style="list-style-type: none"> <li>• the building of sufficient electricity generation capacity to ensure security of supply or to meet environmental targets; or</li> <li>• accomplishment of objectives related to the use of renewable energy sources/or ensuring adequate efficiency.</li> </ul> <p>So far Government did not use the tendering procedure despite the security of supply constraints.</p>	<ul style="list-style-type: none"> <li>• ERO shall issue a written decision that the authorization procedure did not result in sufficient electricity generation capacity to ensure security of supply;</li> <li>• The Government may launch a tendering procedure for the construction of new generation capacities on selected sites;</li> <li>• A tendering procedure shall be conducted by the Public Private Partnerships Inter-Ministerial Steering Committee, in compliance with the Law on Public Private Partnership.</li> <li>• This option may be used for fulfilment of 20MW additional target of solar PV that are required by the Administrative Instruction No. 05/2017 on Renewable Energy Sources Targets.</li> </ul>	<p>Administrative/ Lack of Implementation</p>

Specific barrier	Description of barrier	KESS Recommended Actions	Type of barrier
Market based purchase of new RES capacities (tender / auction)	<p>EnCS Implementation Report 2018/2019 is stating that “amendments to the existing legislation are needed to introduce renewable energy auctions and enable a cost-effective deployment of renewable energy in Kosovo”. The report further recommends that Kosovo must finalize the ongoing revision of the existing laws and regulatory acts to ensure compliance with the Guidelines on State aid for environmental protection and energy 2014 - 2020. A reform of support schemes based on premiums paid on top of the electricity price rather than administrative feed-in tariffs, remains to be introduced.</p> <p>The Policy Guidelines on Competitive Selection and Support for Renewable Energy, prepared by the EBRD and the EnCS in collaboration with the IRENA<sup>16</sup> in March 2018, establishes that the term "auctions" is approach that share the common feature of relying on a competitive process rather than an administrative determination. The term is used to refer to different types of competitive bidding processes – ranging from simple tenders to more complex selection methods.</p> <p>Non-utilization of tendering procedure in the power sector of Kosovo, even though not a barrier per-se, it presents a lost opportunity for achieving better prices than feed-in tariffs through transparent and competitive tendering process.</p>	<ul style="list-style-type: none"> <li>The tendering procedure envisaged in the Article 44 of the Law on the Energy Regulator shall be used by the Government for construction of new RES generation capacities including for PV solar facilities.</li> </ul>	Administrative/Lack of implementation
Activation of One stop Shop	<p>Article 17.6 of the Law on Energy requires the establishment of the <b>One Stop Shop (OSS)</b> through the secondary legal act, with the purpose to facilitate investments in the RES in Kosovo.</p> <p>The Government of Kosovo on March 19th, 2018 adopted the Regulation No. 05/2018 on OSS for Renewable Energy Sources that established the OSS for RES under the Ministry of Economic Development I7, with a purpose to coordinate the activities of institutions responsible for projects</p>	<p>The OSS shall be reactivated and play important as a body responsible to ensure:</p> <ul style="list-style-type: none"> <li>Coordination between different entities involved in the authorization procedure, and</li> </ul>	Administrative

<sup>16</sup> International Renewable Energy Agency (IRENA)

<sup>17</sup> Currently the Ministry of Economic Development is in process of restructuring to become Ministry of Economy and Environment



Specific barrier	Description of barrier	KESS Recommended Actions	Type of barrier
	<p>in RES, and to harmonize and facilitate administrative procedures for issuing relevant permits, licenses and authorizations.</p> <p>OSS for RES shall ensure inter-institutional cooperation through the Inter-institutional Coordination Commission consisting on representatives of all relevant parties in the field of RES. Article 10 of the Regulation require that a special link shall be created on the official website of MED where relevant information shall be published “on the needs of institutions and stakeholders for investments, including links of publications of institutions or responsible authorities in the sector of renewable energy sources.” The assessment of the one-stop shop link on the Ministries’ web site is showing that the OSS is not functional, as there are no reports or information related to coordination and streamline of the projects (either in reducing number of documents required by each institution or duration of different permits and licenses issuance).</p>	<ul style="list-style-type: none"> <li>• Exchange of information on RES in Kosovo, as required by the Regulation No 05/2018</li> <li>• Streamline the authorization procedure between different institutions responsible for granting permits, licenses, or consents.</li> </ul>	
Implementation of Certificate of Origin	<p>The Law on Electricity No. 05/L-085 adopted on July 13, 2016 define that the <b>Certificate of origin</b> is an electronic document issued by ERO which provides proof to the final customer that a given quantity of energy was produced from RES (Article 8). The power certified to originate from RES is entitled to priority dispatch under the Grid Code and Market Rules.</p> <p>According to the law, a Certificate of Origin equates to one MWh of power produced and not more than one certificate shall be issued for each produced unit. ERO shall establish a workable system of Certificate of Origins as a mean to promote RE. This is fully in line with RES Directive No 2009/28/EC.</p> <p>ERO adopted Rule for the Establishment of a System of Certificate of Origin for electricity generated from RE, waste incineration plants and combined-heat-power plants (Rule on Certificates of Origin).</p>	<ul style="list-style-type: none"> <li>• Based on the Law on Electricity ERO developed a Rule on Certificates of Origin<sup>18</sup>, adopted on December 29, 2010, shall be amended to incorporate article 15 of the Directive 2009/28/EC of 23 April 2009 on the promotion of the use of energy from renewable sources that requires that the certificates of origin shall be issued, transferred, and cancelled electronically; and other requirements of the article 15 that currently the rule is missing.</li> <li>• The Rule on Certificate of Origin shall be amended in definitions and references to comply with the current Law on Electricity No.</li> </ul>	Regulatory/Lack of implementation

<sup>18</sup> Rule for the Establishment of a System of Certificates of Origin for Electricity Produced from Renewable Energy Sources, from Waste and Co-Generation in Combination with heat in a single Generating Unit

Specific barrier	Description of barrier	KESS Recommended Actions	Type of barrier
	<p>ERO has not received any application for issuance of Certificates of Origin and still did not established the register of Certificates.</p> <p>The main purpose of using certificates of origin is to show the final consumer that a given share of energy is produced from RES. However, there are other externalities making the certificates attractive. Implementation of the system of certificates of origin can bring benefits facilitating the achievement of targets, including extra revenue for support scheme costs, additional income and increase in renewable energy investment. The lack of a system of Certificate of Origin may impede investors' confidence that Kosovo is following the Energy Community directives and thus constitute a barrier.</p>	<p>05/L-085, since the references and definitions in the current rule belongs to old Law on Electricity 2004 that was replaced by the current law adopted in 2016.</p> <ul style="list-style-type: none"> <li>• ERO shall establish electronic register of certificates and develop a generic form of a Certificate. (Without the register in place and all required forms for certification published and available for RES investors, it is unlikely that ERO will receive any application for certificate of origin.)</li> </ul>	
Distribution System Operator KEDS	<p>All the businesses that applied for connection of new RES generation capacities have reported fundamental problems with KEDS with regards to connection to the grid. In certain occasions KEDS has attempted to reject the requests for connections and proposing connection through transmission system network, while in economic and technical terms these installations are suitable for connection to the distribution network.</p> <p>Moreover, KEDS has obliged renewable energy businesses to perform deep connection, including construction of kilometers of overhead line, which is not technically and commercially feasible.</p> <p>The investments done by the investors are of tremendous value and not all of them are necessary.</p>	<ul style="list-style-type: none"> <li>• ERO shall review technical requirements imposed by KEDS on investors and evaluate if these requirements are applied in a transparent, non-discriminatory, and proportional manner. (Regular monitoring by ERO shall ensure that the RE-self-consumers are not charged in access and in disproportional manner.)</li> <li>• ERO shall adopt the draft connection methodology</li> </ul>	Regulatory
Full compliance with EU Directives	<p>Article 1 para. 2 of the Law on Energy states that the <b>law is partially in compliance</b> with Directive No. 2009/28/EC concerning promotion of use of energy from renewable energy sources. The Directive 2009/28/EC will be amended during the 2021 to include latest modifications made in the new Directive (EU) 2018/2001, which will proceed by CPs transposing such mandatory dispositions of the new RES directive in their national laws.</p>	<ul style="list-style-type: none"> <li>• Transposing the new requirements applicable to RES shall be done <b>in full compliance</b> with that directive. Transposing the directive only partially is not the best solution since it prevents investors to implement different opportunities for the development of the RES sector.</li> </ul>	Legal

Specific barrier	Description of barrier	KESS Recommended Actions	Type of barrier
Definition of overall targets for the share of energy from RES	Article 15 of the law defines the Renewable Energy Targets and established that a National Renewable Energy Action Plan shall reach <b>twenty-five percent (25%) share of energy</b> from renewable sources in gross final energy consumption for an agreed in 2020. Which is in line with Directive 2009/28/EC of 23 April 2009 on the promotion of the use of energy from RES, as set forth in specific national targets identified in the Annex I of RES Directive. Inclusion of 25% overall target for the share of RES in the law on energy is not the best legal practice since the defined target will be modified through the new RES Directive that will replace Directive 2009/28/EC. Inclusion of numeric value of target means that every modification of RES Directive to modify target will follow by modification of the Law on Energy to reflect such modification.	<ul style="list-style-type: none"> <li>Replace numerical value of the target (25%) in Article 15 the Law on energy with reference only to Annex I of the Directive which defines national targets. By doing so it will not be necessary to modify the Law on Energy whenever the EU and EC Directives modify overall target for the share of RES.</li> </ul>	Legal
Simplified procedure introduced in all institutions involved in granting authorization or permits	The Administrative Instruction No. 06/2017 On Utilization and Support of Energy Generation from Renewable Sources (August 7, 2017) requires that projects of up to 100 kW shall be subject to simple authorization procedure adopted by ERO <b>and other relevant institutions dealing with permitting issues</b> . In April 2017 ERO adopted the Rule on Authorization of New Generation Capacities for RES Generators that enhanced a simplified procedure for RES projects, albeit it seems that other institutions responsible for licensing and permitting did not manage to simplify their own requirements.	<ul style="list-style-type: none"> <li>The simplified authorization procedure shall apply to all institutions that grants any kind of authorization or permits for construction of new generating facilities</li> <li>The OSS, after becoming active and operational, is the place to address and solve this issue.</li> </ul>	Administrative/Lack of implementation
Funding the Renewable Energy Fund	Article 13 of the Rule on Support Scheme sets forth that the additional costs incurred to support the development of RES projects admitted to the Support Scheme is compensated through the Renewable Energy Fund, managed by the MO. Funding of the Renewable Energy Fund is provided through a Renewable Energy Charge applicable at transmission level to all suppliers of electricity in Kosovo. Article 16.6 of the Market Rule is stating the same.  The Renewable Energy Fund is funded by the difference between the Reference Price and the Feed-in Tariff (among other sources).	<ul style="list-style-type: none"> <li>ERO shall modify the Rule on Support Scheme, and the Market rules that are both based on the same principles for funding the Renewable Energy Fund through difference between the reference price and feed-in tariffs.</li> <li>ERO shall define the support mechanism that will replace feed-in tariffs and define the manner how the Renewable Energy Fund will be financed in the absence of feed-in tariffs.</li> </ul>	Regulatory

Specific barrier	Description of barrier	KESS Recommended Actions	Type of barrier
	<p>The Decision adopted by ERO to terminate feed-in tariffs is directly impacting the mechanism for financing the Renewable Energy Fund and the draft Methodology on reference price is still not adopted by ERO.</p>		
<p>Responsibility of the ERO Board in relation to prosumers</p>	<p>In accordance to Article 16, paragraph 4 of the Rule on authorization of new generation capacities from RES, the Board of ERO is responsible to issue authorization for large-scale generators and small-scale generators (including renewable self- consumers).</p> <p>The rule does not differentiate between large and small scale generators and requires that each and every authorization shall be approved by the ERO Board.</p> <p>In the absence of the full Board in place this may cause delay in approval.</p>	<ul style="list-style-type: none"> <li>• ERO shall consider if there is any reason for the ERO Board to be responsible for approval of renewable self- consumers.</li> <li>• The prosumers shall be treated directly by the DSO, as it is the practice in the most CPS of the Energy Community. This is in line with the ECRB report, which states that Kosovo is presently an exception to other CPs of the EnC, where the prosumers` status is obtained by direct application to the DSO with no involvement of the regulatory authorities.</li> <li>• The DSO shall be obliged to keep register of prosumers` and inform ERO on each granted prosumer status.</li> </ul>	<p>Regulatory</p>

**U.S. Agency for International Development/Country**

Office Address Optional

**[www.usaid.gov](http://www.usaid.gov)**